

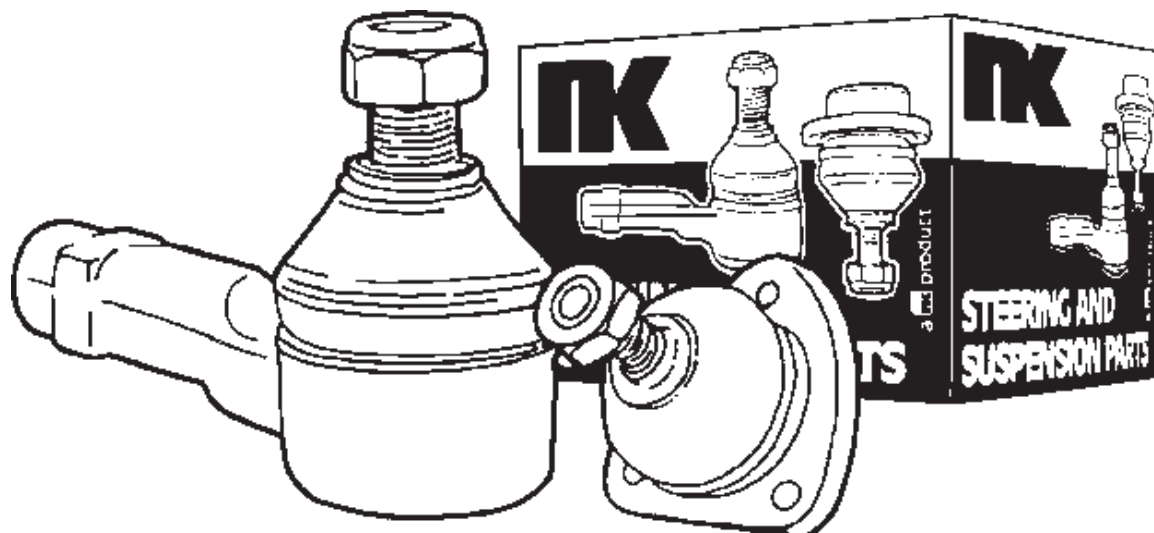



LENKUNGSTEILE

ALFA ROMEO - YUGO



BRUGSVEJLEDNING & INDHOLDSFORTEGNELSE
DIRECTIONS FOR USE & CONTENTS
BESTELLHINWEISE & INHALTSVERZEICHNIS

500....	Styrestang	Drag link	Spurstange
501....	Bærearml	Track control arm	Querlenker
502....	Tandstang	Steering rack	Lenkgetriebe
503....	Styrekugle	Tie rod end	Kugelgelenk/Axialgelenk
504....	Bærekugle	Ball joint	Radgelenk
507....	Styreboltsæt	King pin set	Gelenkzapfen
508....	Endestykke	Tie rod end	Spurstangenendstück
509....	Manchetsæt	Boot kit	Manschettensatz
510....	Reparationssæt/Bøsninger	Repair kit/Bush	Reparatursatz/Gummilager
511....	Stabilesatorbolte	Stabilizer bolts	Stabilisatorbolzen
xxxxxxx	Under oprettelse	In preparation	In Vorbereitung

	Hoved Gruppe nr. Main Group no. Hauptgruppen nr.	Side Page Seite		Hoved Gruppe nr. Main Group no. Hauptgruppen nr.	Side Page Seite
Alfa Romeo	10	5	MCC	33	271
Audi	47	15	Mitsubishi	30	273
Autobianchi = Lancia			Nissan	22	301
BMC = Rover Group			Opel	36	331
BMW	15	47	Peugeot	37	363
Chrysler	93	73	Polski Fiat	23	385
Citroen	19	75	Renault	39	387
Dacia	39	95	Rover Group	12	407
Daewoo	50	97	Land Rover		
Daihatsu	51	103	Rover		
Fiat/Iveco	23	107	Saab	41	417
Ford	25	137	Seat	23	421
Honda	26	165	Skoda	43	435
Hyundai	34	183	Subaru	44	441
Isuzu	14	197	Suzuki	52	443
Jeep	93	201	Talbot	18	449
Kia	35	203	Toyota	45	453
Lada	23	213	Vauxhall	36	489
Lancia	23	215	VW VAG	47	509
Mazda	32	221	Volvo	48	549
Mercedes-Benz	33	243	Wartburg	49	561
			Yugo	23	563
Anvendelsesliste/Buyer's guide/Nummerische Liste				Side/Page/Seite	565

500 36 14

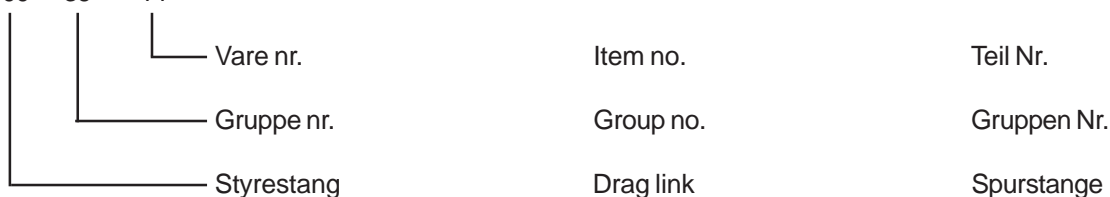

Vi gør opmærksom på, at gruppe nr. kan forekomme indenfor flere bilmærker.

Please notice that group no. can occur in more than one mark.

Bitte beachten Sie, dass diese Artikelnummern bei mehreren Fahrzeuganwendungen verwendet wird.

FORKORTELSER

ABBREVIATIONS

ABKÜRZUNGEN

V/H : Venstre / Højre

L/R :

U : Udgår

Left / Right

Available only while stock last

Links / Rechts

entfällt

Vi gør opmærksom på at forskelle i detaljer kan forekomme mellem katalogets illustrationer og det virkelige produkt.

Please accept slight differences in detail between real products and catalogue pictures.

Die Abbildungen im Katalog können aus druchtechnischen Gründen geringfügig vom Originalteil abweichen.

NK Varenumre der ikke fremtræder i prislisten kan være under udarbejdelse.
Ring og forhør.

NK Nos. which are not in the price list might be in course of preparation.
Please call and ask.

NK Nr., die nicht in der Preisliste sind, können in Ausarbeitung sein.
Bitte anrufen und erfragen.

Dette katalog er udarbejdet med største omhyggelighed, dog kan vi ikke påtage os ansvar for eventuelle fejl.
Bilfabrikanter og andre reservedelsnumre er kun nævnt som reference.

Every effort has been made to ensure that the information in this catalogue is correct.
However we cannot accept any responsibility for errors which may occur.
Vehicle manufacturers and component suppliers part numbers are listed for information only.

Alle Angaben in diesem Katalog sind mit größter Sorgfalt erstellt worden, jedoch können Ersatzansprüche auf Grund evt. Fehlangaben nicht anerkannt werden.
Die verwendeten Original-Nummern der Fahrzeug-Herstellern dienen ausschließlich Vergleichszwecken.

Garanti

Garantien dækker almindelig ombytning af den defekte del, når NK har godkendt fejlen. Den defekte del må indsendes franko og reklamationer må være ledsaget af en udfyldt rapport, for at blive behandlet.

Copyright

Mekanisk, fotografisk eller anden gengivelse af dette katalog eller dele heraf er ikke tilladt.

Alle rettigheder forbeholdes.

Guarantee and compensation

The guarantee covers usual replacement of the defect part, following approval by NK of the defect. The defect part must be forwarded to us carriage paid, and a duly prepared report of the complaint must be enclosed to receive our attention.

Copyright

All rights reserved. No part of this catalogue may be reproduced, stored in a retrieval system or transmitted, in any form or by any means, electronic, mechanical, photocopying, recording or otherwise.

Information in this catalogue are subject to alteration.

Gewährleistung

Unsere Haftung für mangelhafte Ware, Bearbeitung, Montage oder andere Mängel beschränkt sich auf den Ersatz der von NK als fehlershaft anerkannten Ware. Mit jeder Meldung eines Mangels ist uns franko die beanstandete Ware zur Prüfung zur Verfügung zu stellen. Geschieht das nicht, entfallen alle Mängelansprüche.





Copyright

Wir behalten uns alle Rechte vor. Vervielfältigung oder Mitbenutzung dieses Kataloges - auch auszugsweise - für die Erstellung eines Eigenkataloges ist ohne Zustimmung unzulässig.







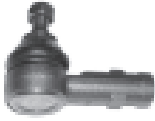

Katalogangaben sind ohne Gewähr.

©NK2008



















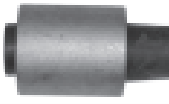

POS	 Alfasud 1971-12/89
	Foraksel/Front axle/Vorneachse
1	<p>5031001 V/H - L/R 14x1,0 RHT Konus/Cone 13 mm. Styrekugle/Tie rod end/Kugelgelenk Yderste/Outer/Außen</p>  <p>1</p>
POS	 Alfa 33 7/83-9/94 & Arna 1983-12/86
1	<p>5031001 V/H - L/R 14x1,0 RHT Konus/Cone 13 mm. Styrekugle/Tie rod end/Kugelgelenk Yderste/Outer/Außen</p>  <p>1</p>
2	<p>5041002 V/H - L/R Bærekugle/Ball joint/Radgelenk Nederste/Lower/Unten</p>  <p>2</p>

ALFA ROMEO

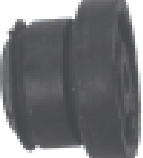

POS	 Alfetta 1.6/1.8/2.0 1972-1/86 & Giulietta 1.3/1.6 10/77-12/85
Foraksel/Front axle/Vorneachse	
1	<p>5031002 V/H - L/R Styrekugle/Tie rod end/Kugelgelenk 14x1,5 RHT Konus/Cone 14 mm. Yderste/Outer/Außen</p>
2	<p>5031003 U V/H - L/R Styrekugle/Tie rod end/Axialgelenk 14x1,5 RHT Inderste/Inner</p>
3	<p>5041004 V/H - L/R Bærekugle/Ball joint/Radgelenk Nederste/Lower/Unten</p>
4	<p>5041005 V/R - L/R Bærekugle/Ball joint/Radgelenk Øverste/Upper/Oben</p>
	 <p style="text-align: center;">1</p>  <p style="text-align: center;">2</p>  <p style="text-align: center;">3</p>  <p style="text-align: center;">4</p>
POS	 Alfa 75 5/85-2/92 & Alfa 90 10/84-7/87
Foraksel/Front axle/Vorneachse	
1	<p>5031002 V/H - L/R Styrekugle/Tie rod end/Kugelgelenk 14x1,5 RHT Konus/Cone 14 mm. Yderste/Outer/Außen</p>
2	<p>5031003 U V/H - L/R Styrekugle/Tie rod end/Axialgelenk 14x1,5 RHT Inderste/Inner</p>
3	<p>5041004 V/H - L/R Bærekugle/Ball joint/Radgelenk Nederste/Lower/Unten</p>
4	<p>5041005 V/H - L/R Bærekugle/Ball joint/Radgelenk Øverste/Upper/Oben</p>
	 <p style="text-align: center;">1</p>  <p style="text-align: center;">2</p>  <p style="text-align: center;">3</p>  <p style="text-align: center;">4</p>

POS	 Alfa 145 1.4/1.6/1.7 10/94-1/01 & Alfa 146 1.4/1.6/1.7 10/94-1/01
Foraksel/Front axle/Vorneachse	
1	5001001 Venstre/Left/Links Styrestang/Steering rod/Spurstange
2	5001002 Højre/Right/Rechs Styrestang/Steering rod/Spurstange
3	5011001 Venstre/Left/Links Bæream/Track control arm/Querlenker
4	5011002 Højre/Right/Rechs Bæream/Track control arm/Querlenker
5	5031007 Venstre/Left/Links Styrekugle/Tie rod end/Kugelgelenk
6	5031008 Højre/Right/Rechs Styrekugle/Tie rod end/Kugelgelenk
7	5091006 Manchetsæt/Boot kit/Manschetten satz
8	5101001 Bag/Rear/Hinten Bøsning/Bushing/Buchsen
9	5101002 Bag/Rear/Hinten Bøsning/Bushing/Buchsen
10	5101003 For/Front/Vorne Bøsning/Bushing/Buchsen
11	5112301 V/H - L/R Stabilisator/Stabilizer/Stabilisator
	 <p>14x1,5 RHT Yderste/Outer/Außen</p> <p>14x1,5 LHT Yderste/Outer/Außen</p> <p>Venstre/Left/Links</p> <p>Højre/Right/Rechs</p> <p>Ø12mm. 100mm.</p>





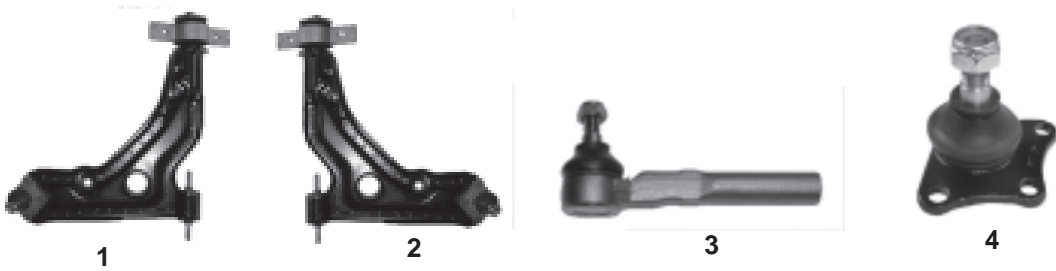

POS	

POS	Alfa 147 01/01- & Alfa 156 11/97-		
		Foraksel/Front axle/Vorneachse	
1	5001003 Styrestang/Steering rod/Spurstange		 1
2	5011003 Venstre/Left/Links Bæream/Track control arm/Querlenker	Stål/Steel/Stahl Nederste/Lower/Unten	 2
3	5011004 Højre/Right/Rechs Bæream/Track control arm/Querlenker	Stål/Steel/Stahl Nederste/Lower/Unten	 3
4	5011005 Venstre/Left/Links Bæream/Track control arm/Querlenker	Aluminium Øverste/Upper/Oben	 4
5	5011006 Højre/Right/Rechs Bæream/Track control arm/Querlenker	Aluminium Øverste/Upper/Oben	 5
6	5031011 Venstre/Left/Links Styrekugle/Tie rod end/Kugelgelenk	14x1,5 RHT Yderste/Outer/Außen	 6
7	5031012 Højre/Right/Rechs Styrekugle/Tie rod end/Kugelgelenk	14x1,5 RHT Yderste/Outer/Außen	 7
8	5091005 Manchetsæt/Boot kit/Manschetten satz		 8
9	5101004 Midterste/Center/Mitte Bøsning/Bushing/Buchsen		 9
10	5101005 Bag/Rear/Hinten Bøsning/Bushing/Buchsen	Venstre/Left/Links Nederste/Lower/Unten	 10
11	5101006 Bag/Rear/Hinten Bøsning/Bushing/Buchsen	Højre/Right/Rechs Nederste/Lower/Unten	 11
POS			
12	5101007 For/Front/Vorne Bøsning/Bushing/Buchsen	Venstre/Left/Links Nederste/Lower/Unten	 12
13	5101008 For/Front/Vorne Bøsning/Bushing/Buchsen	Højre/Right/Rechs Nederste/Lower/Unten	 13
14	5101009 V/H - L/R Bøsning/Bushing/Buchsen		
15	5111002 V/H - L/R Stabilisatorstang/Stabilizer rod/Diagonalstrebe	130 mm.	 15
		Bagaksel/Rear axle/Hinterachse	
16	5001005 For/Front/Vorne Styrestang/Steering rod/Spurstange	V/H - L/R	 14
17	5001006 Bag/Rear/Hinten Styrestang/Steering rod/Spurstange	V/H - L/R 592 mm.	 16
18	5111003 V/H - L/R Stabilisatorstang/Stabilizer rod/Diagonalstrebe	180 mm.	 17
			 18

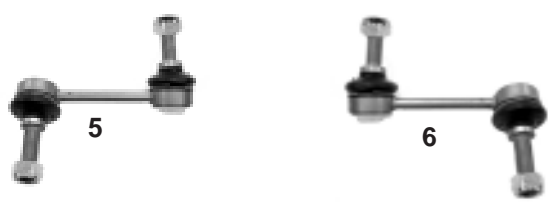
POS	Alfa 155 2/92-12/97		
Foraksel/Front axle/Vorneachse			
1	5011001 Venstre/Left/Links Bærearmlenke/Track control arm/Querlenker		
2	5011002 Højre/Right/Rechs Bærearmlenke/Track control arm/Querlenker		
3	5031006 V/H - L/R Styrekugle/Tie rod end/Axialgelenk	12x1,5 RHT (**) Inderste/Inner	
4	5032333 Venstre/Left/Links Styrekugle/Tie rod end/Kugelgelenk	12x1,5 RHT Yderste/Outer/Außen	
5	5032334 Højre/Right/Rechs Styrekugle/Tie rod end/Kugelgelenk	12x1,5 RHT Yderste/Outer/Außen	
6	5091004 Manchetsæt/Boot kit/Manschetten satz		
7	5101001 Bag/Rear/Hinten Bøsning/Bushing/Buchsen	Venstre/Left/Links	
8	5101002 Bag/Rear/Hinten Bøsning/Bushing/Buchsen	Højre/Right/Rechs	
9	5101003 For/Front/Vorne Bøsning/Bushing/Buchsen	V/H - L/R	
10	5112301 V/H - L/R Stabilisator/Stabilizer/Stabilisator	Ø12mm. 100 mm.	
POS Alfa 159 9/05-			
Foraksel/Front axle/Vorneachse			
1	5031015 Venstre/Left/Links Styrekugle/Tie rod end/Kugelgelenk	20x1,5 RHT	
2	5031016 Højre/Right/Rechs Styrekugle/Tie rod end/Kugelgelenk	20x1,5 RHT	
3	XXXXXXX Venstre/Left/Links Stabilisator arm/Stabilizer lever/Stabilisator hebel	Ø8mm. 102 mm.	
4	XXXXXXX Højre/Right/Rechs Stabilisator arm/Stabilizer lever/Stabilisator hebel	Ø8mm. 102 mm.	
Bagaksel/Rear axle/Hinterachse			
5	5111009 Venstre/Left/Links Stabilisator/Stabilizer/Stabilisator		
6	5111010 Højre/Right/Rechs Stabilisator/Stabilizer/Stabilisator		
			(**) Med Servo Styling With Power Steering Mit Servolenkung

POS	 Alfa 164 6/87-9/98
Foraksel/Front axle/Vorneachse	
1	5012313 Venstre/Left/Links (O.E. 60801528,82406867) - 12/91 Bæream/Track control arm/Querlenker Nederste/Lower/Unten
2	5012314 Højre/Right/Rechs (O.E. 60801529,82406868) - 12/91 Bæream/Track control arm/Querlenker Nederste/Lower/Unten
3	5032330 V/H - L/R 14x1,5 RHT (O.E. 60801529,82406868) Styrekugle/Tie rod end/Kugelgelenk Yderste/Outer/Außen
4	5042311 V/H - L/R Ø13mm. 12x1,25 RHT (O.E. 60801528,82406867) - 12/91 Bærekugle/Ball joint/Radgelenk Nederste/Lower/Unten
	
POS	

POS	Alfa 166 9/98-			
		Foraksel/Front axle/Vorneachse		
1	5011007 Venstre/Left/Links Bærearmlenke/Track control arm/Querlenker	Stål/Steel/Stahl Nederste/Lower/Unten		
2	5011008 Højre/Right/Rechs Bærearmlenke/Track control arm/Querlenker	Stål/Steel/Stahl Nederste/Lower/Unten		
3	5011009 Venstre/Left/Links Bærearmlenke/Track control arm/Querlenker	Øverste/Upper/Oben		
4	5011010 Højre/Right/Rechs Bærearmlenke/Track control arm/Querlenker	Øverste/Upper/Oben		
5	5031011 Venstre/Left/Links Styrekugle/Tie rod end/Kugelgelenk	14x1,5 RHT Yderste/Outer/Außen		
6	5031012 Højre/Right/Rechs Styrekugle/Tie rod end/Kugelgelenk	14x1,5 RHT Yderste/Outer/Außen		
7	5031013 V/H - L/R Styrekugle/Tie rod end/Kugelgelenk	14x1,5 RHT Inderste/Inner		
8	5091005 Manchetsæt/Boot kit/Manschetten satz			
9	5101010 Bag/Rear/Hinten Bøsning/Bushing/Buchsen	V/H - L/R Nederste/Lower/Unten		
10	5101011 Midterste/Center/Mitte Bøsning/Bushing/Buchsen	Nederste/Lower/Unten		
11	5101012 For/Front/Vorne Bøsning/Bushing/Buchsen	V/H - L/R Nederste/Lower/Unten		
			10	11
POS				
12	5101013 V/H - L/R Bøsning/Bushing/Buchsen	Øverste/Upper/Oben		
13	5111004 V/H - L/R Stabilisatorstang/Stabilizer rod/Diagonalstrebe	148 mm.		
		Bagaksel/Rear axle/Hinterachse		
14	5111005 Venstre/Left/Links Stabilisatorstang/Stabilizer rod/Diagonalstrebe	95 mm.		
15	5111006 Højre/Right/Rechs Stabilisatorstang/Stabilizer rod/Diagonalstrebe	95 mm.		

POS	Brera 1/06-			
Foraksel/Front axle/Vorneachse				
1	5031015	Venstre/Left/Links	20x1,5 RHT	
		Styrekugle/Tie rod end/Kugelgelenk		
2	5031016	Højre/Right/Rechs	20x1,5 RHT	
		Styrekugle/Tie rod end/Kugelgelenk		
3	XXXXXXX	Venstre/Left/Links	Ø8mm. 102 mm.	
		Stabilisator arm/Stabilizer lever/Stabilisator hebel		
4	XXXXXXX	Højre/Right/Rechs	Ø8mm. 102 mm.	
		Stabilisator arm/Stabilizer lever/Stabilisator hebel		
Bagaksel/Rear axle/Hinterachse				
5	5111009	Venstre/Left/Links		
		Stabilisator/Stabilizer/Stabilisator		
6	5111010	Højre/Right/Rechs		
		Stabilisator/Stabilizer/Stabilisator		
POS	GTV 1995 & GTV 6/95- & Spider 1995 & Spider 6/95-			
Foraksel/Front axle/Vorneachse				
1	5011001	Venstre/Left/Links		
		Bærearmlen/Track control arm/Querlenker		
2	5011002	Højre/Right/Rechs		
		Bærearmlen/Track control arm/Querlenker		
3	5091004			
		Manchetsæt/Boot kit/Manschetten satz		
4	5101001	Bag/Rear/Hinten	Venstre/Left/Links	
		Bøsning/Bushing/Buchsen		
5	5101002	Bag/Rear/Hinten	Højre/Right/Rechs	
		Bøsning/Bushing/Buchsen		
6	5101003	For/Front/Vorne	V/H - L/R	
		Bøsning/Bushing/Buchsen		
7	5112301	V/H - L/R	Ø12mm. 100 mm.	
		Stabilisator/Stabilizer/Stabilisator		
Bagaksel/Rear axle/Hinterachse				
8	5041006	V/H - L/R		
		Bærekugle/Ball joint/Radgelenk		
9	5111007	Venstre/Left/Links	95 mm.	
		Stabilisatorstang/Stabilizer rod/Diagonalstrebe		
10	5111008	Højre/Right/Rechs	95 mm.	
		Stabilisatorstang/Stabilizer rod/Diagonalstrebe		

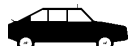
POS	
POS	

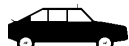





























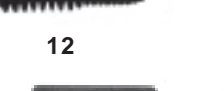

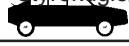

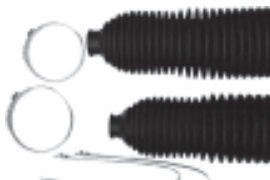

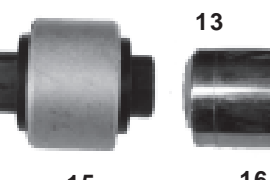
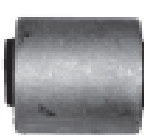
POS	
POS	

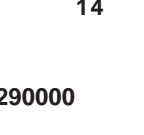
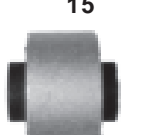
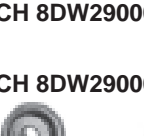

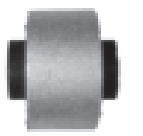
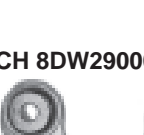

POS	A2 2/00-		
Foraksel/Front axle/Vorneachse			
1	5014735 Venstre/Left/Links (1.4) (**) Bæream/Track control arm/Querlenker	Nederste/Lower/Unten	
2	5014736 Højre/Right/Rechs(1.4) (**) Bæream/Track control arm/Querlenker	Nederste/Lower/Unten	
3	5034771 V/H - L/R (1.4) (**) Styrekugle/Tie rod end/Axialgelenk	Inderste/Inner	
4	5034774 V/H - L/R (1.2) (**) Styrekugle/Tie rod end/Axialgelenk	Inderste/Inner	
5	5034775 Venstre/Left/Links Styrekugle/Tie rod end/Kugelgelenk	14x1,5 RHT Konus/Cone 14,0 mm. (**)	
6	5034776 Højre/Right/Rechs Styrekugle/Tie rod end/Kugelgelenk	14x1,5 RHT Konus/Cone 14,0 mm. (**)	
7	5094707 (1.4 16V) (**) Manchetsæt/Boot kit/Manschetten satz		
8	5094708 (-1.4 16V) (**) Manchetsæt/Boot kit/Manschetten satz		
9	5104728 For/Front/Vorne V/H - L/R Bøsning/Bushing/Buchsen		
10	5104729 Bag/Rear/Hinten V/H - L/R Bøsning/Bushing/Buchsen		
11	5114719 V/H - L/R (-1.2) Stabilisatorstang/Stabilizer rod/Diagonalstrebe		
12	5114720 V/H - L/R (1.2) Stabilisatorstang/Stabilizer rod/Diagonalstrebe		

(**) **Med Servo Styring
 With Power Steering
 Mit Servolenkung**

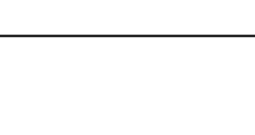
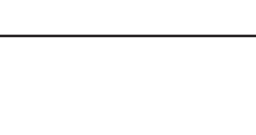
POS	A3 (8L1) 6/96-
Foraksel/Front axle/Vorneachse	
1	5004772 Venstre/Left/Links - 10/97 Styrestang/Steering rod/Spurstange
2	5004773 Højre/Right/Rechs - 10/97 Styrestang/Steering rod/Spurstange
3	5014717 Venstre/Left/Links Bærearmlenke/Track control arm/Querlenker
4	5014718 Højre/Right/Rechs Bærearmlenke/Track control arm/Querlenker
5	5034753 Venstre/Left/Links - 10/97 14x1,5 RHT Styrekugle/Tie rod end/Kugelgelenk Yderste/Outer/Außen
6	5034754 Højre/Right/Rechs - 10/97 14x1,5 RHT Styrekugle/Tie rod end/Kugelgelenk Yderste/Outer/Außen
7	5034757 V/H - L/R 11/97 - 14x1,5 RHT Styrekugle/Tie rod end/Axialgelenk Inderste/Inner
8	5034769 Højre/Right/Rechs 11/97 - 14x1,5 RHT Styrekugle/Tie rod end/Kugelgelenk Yderste/Outer/Außen
9	5034770 Venstre/Left/Links 11/97 - 14x1,5 RHT Styrekugle/Tie rod end/Kugelgelenk Yderste/Outer/Außen
10	5044738 Venstre/Left/Links Bærekugle/Ball joint/Radgelenk Nederste/Lower/Unten
11	5044739 Højre/Right/Rechs Bærekugle/Ball joint/Radgelenk Nederste/Lower/Unten
POS	
12	5094709 Manchetsæt/Boot kit/Manschettensatz
13	5104708 Bag/Rear/Hinten V/H - L/R (- S3 quattro) Bøsning/Bushing/Buchsen
14	5104720 For/Front/Vorne V/H - L/R Bøsning/Bushing/Buchsen
15	5104736 Bag/Rear/Hinten V/H - L/R (S3 quattro) Bøsning/Bushing/Buchsen
16	5114702 Ø21 mm. 106 mm. Stabilisator arm/Stabilizer lever/Stabilisator hebel

POS	A3 3/03-			
Foraksel/Front axle/Vorneachse				
1	5014743 Venstre/Left/Links Bæream/Track control arm/Querlenker	(-Diesel) Nederste/Lower/Unten		
2	5014744 Højre/Right/Rechs Bæream/Track control arm/Querlenker	(-Diesel) Nederste/Lower/Unten		
3	5014745 Venstre/Left/Links Bæream/Track control arm/Querlenker	(Diesel) Nederste/Lower/Unten		
4	5014746 Højre/Right/Rechs Bæream/Track control arm/Querlenker	(Diesel) Nederste/Lower/Unten		
5	5034780 V/H - L/R Styrekugle/Tie rod end/Axialgelenk	16x1,5 RHT		
6	5034781 Venstre/Left/Links Styrekugle/Tie rod end/Kugelgelenk	16x1,5 RHT		
7	5034782 Højre/Right/Rechs Styrekugle/Tie rod end/Kugelgelenk	16x1,5 RHT		
8	5044743 Venstre/Left/Links Bærekugle/Ball joint/Radgelenk	Nederste/Lower/Unten		
9	5044744 Højre/Right/Rechs Bærekugle/Ball joint/Radgelenk	Nederste/Lower/Unten		
10	5104737 Bag/Rear/Hinten Bøsning/Bushing/Buchsen	Venstre/Left/Links Nederste/Lower/Unten		
11	5104738 Bag/Rear/Hinten Bøsning/Bushing/Buchsen	Højre/Right/Rechs Nederste/Lower/Unten		
POS				
12	5104739 For/Front/Vorne V/H - L/R Bøsning/Bushing/Buchsen	Nederste/Lower/Unten		
13	5114723 V/H - L/R 335 mm. Stabilisatorstang/Stabilizer rod/Diagonalstrebe			
Bagaksel/Rear axle/Hinterachse				
14	5114726 V/H - L/R Stabilisator bolt/Stabilizer bolt/Stabilisator bolzen			
15	xxxxxxx V/H - L/R Bøsning/Bushing/Buchsen			

POS		A4 (8D2, B5) 1/95-11/00 & A4 Avant (8D5, B5) 1/95-9/01 & A4 Quattro (8D2, B5/8D5, B5) 1/95-9/01			
		Foraksel/Front axle/Vorneachse			
1		5004774 V/H - L/R Styrestang/Steering rod/Spurstange		1	2
2		5014716 For/Front/Vorne Bærearmlenke/Track control arm/Querlenker	V/H - L/R Nederste/Lower/Unten		
3		5014719 Bag/Rear/Hinten Bærearmlenke/Track control arm/Querlenker	Venstre/Left/Links Nederste/Lower/Unten		
4		5014720 Bag/Rear/Hinten Bærearmlenke/Track control arm/Querlenker	Højre/Right/Rechts Nederste/Lower/Unten		
5		5014727 For/Front/Vorne Bærearmlenke/Track control arm/Querlenker	Venstre/Left/Links Øverste/Upper/Oben		
6		5014728 For/Front/Vorne Bærearmlenke/Track control arm/Querlenker	Højre/Right/Rechts Øverste/Upper/Oben		
7		5014733 Bag/Rear/Hinten Bærearmlenke/Track control arm/Querlenker	Venstre/Left/Links Øverste/Upper/Oben		
8		5014734 Bag/Rear/Hinten Bærearmlenke/Track control arm/Querlenker	Højre/Right/Rechts Øverste/Upper/Oben		
9		5014738 V/H - L/R Bærearmlenke/Track control arm/Querlenker			
10		5034755 V/H - L/R Styrekugle/Tie rod end/Axialgelenk	14x1,5 RHT Inderste/Inner		
11		5034756 V/H - L/R Styrekugle/Tie rod end/Kugelgelenk	14x1,5 RHT Yderste/Outer/Außen		
POS					
12		5094710 Ø 18/54 mm. 200 mm. Manchetsæt/Boot kit/Manschetten satz	6Cyl./Zyl.		
13		5094711 (4 Cyl./Zyl.) Manchetsæt/Boot kit/Manschetten satz			
14		5104714 For/Front/Vorne Bøsning/Bushing/Buchsen	V/H - L/R		
15		5104715 Bag/Rear/Hinten Bøsning/Bushing/Buchsen	V/H - L/R		
16		5104716 V/H - L/R Bøsning/Bushing/Buchsen	Nederste/Lower/Unten		
17		5104717 V/H - L/R Bøsning/Bushing/Buchsen	Øverste/Upper/Oben		
18		5114705 V/H - L/R Stabilisatorstang/Stabilizer rod/Diagonalstrebe	70 mm. CH -8DW290000		
19		5114717 Venstre/Left/Links Stabilisatorstang/Stabilizer rod/Diagonalstrebe	Aluminium 90 mm. CH 8DW290001-		
20		5114718 Højre/Right/Rechts	Aluminium 90 mm. CH 8DW290001-		
					





















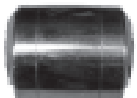

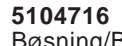
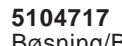
POS	 A4 (8D2, B5) 1/95-11/00 & A4 Avant (8D5, B5) 1/95-9/01 & A4 Quattro (8D2, B5/8D5, B5) 1/95-9/01
	<p>Bagaksel/Rear axle/Hinterachse</p> <p>21 5014749 V/H - L/R Bærearmlenke/Track control arm/Querlenker Nederste/Lower/Unten</p> <p>22 5114708 Venstre/Left/Links Ø10 mm. 230 mm. Quattro Stabilisatorstang/Stabilizer rod/Diagonalstrebe</p> <p>23 5114709 Højre/Right/Rechts Ø10 mm. 230 mm. Quattro Stabilisatorstang/Stabilizer rod/Diagonalstrebe</p> <div style="text-align: center;">  <p>22</p>  <p>23</p> </div>
POS	





POS		A4 (8E2,B6) 11/00- & A4 Avant (8E5,B6) & A4 Quattro (8E2,B6/8E5,B6) 11/00-	9/01- & A4 Cabriolet (8H) 4/02-	
		Stabilisatorstang/Stabilizer rod/Diagonalstrebe		
		Foraksel/Front axle/Vorneachse		
1		5004774 V/H - L/R Styrestang/Steering rod/Spurstange		
2		5014719 Bag/Rear/Hinten Bærear/Track control arm/Querlenker	Venstre/Left/Links Nederste/Lower/Unten	
3		5014720 Bag/Rear/Hinten Bærear/Track control arm/Querlenker	Højre/Right/Rechs Nederste/Lower/Unte	
4		5014727 For/Front/Vorne Bærear/Track control arm/Querlenker	Venstre/Left/Links Øverste/Upper/Oben	
5		5014728 For/Front/Vorne Bærear/Track control arm/Querlenker	Højre/Right/Rechs Øverste/Upper/Oben	
6		5014733 Bag/Rear/Hinten Bærear/Track control arm/Querlenker	Venstre/Left/Links Øverste/Upper/Oben	
7		5014734 Bag/Rear/Hinten Bærear/Track control arm/Querlenker	Højre/Right/Rechs Øverste/Upper/Oben	
8		5014747 For/Front/Vorne Bærear/Track control arm/Querlenker	V/H - L/R Nederste/Lower	
9		5014748 V/H - L/R Bærear/Track control arm/Querlenker		
10		5034755 V/H - L/R Styrekugle/Tie rod end/Axialgelenk	4x1,5 RHT Inderste/Inner	
11		5034756 V/H - L/R Styrekugle/Tie rod end/Kugelgelenk	14x1,5 RHT Yderste/Outer/Außen	
POS				
12		5104714 For/Front/Vorne Bøsning/Bushing/Buchsen	V/H - L/R	
13		5104715 Bag/Rear/Hinten Bøsning/Bushing/Buchsen	V/H - L/R	
14		5104716 V/H - L/R Bøsning/Bushing/Buchsen	Nederste/Lower/Unten	
15		5104717 V/H - L/R Bøsning/Bushing/Buchsen	Øverste/Upper/Oben	
16		5114737 Venstre/Left/Links Stabilisatorstang/Stabilizer rod/Diagonalstrebe		
17		5114738 Højre/Right/Rechs Stabilisatorstang/Stabilizer rod/Diagonalstrebe		
18		5114748 Højre/Right/Rechs Stabilisator/Stabilizer/Stabilisator	62,5 mm.	
		Bagaksel/Rear axle/Hinterachse		
19		5114708 Venstre/Left/Links Stabilisatorstang/Stabilizer rod/Diagonalstrebe	Quattro Ø10 mm. 230 mm.	
20		5114709 Højre/Right/Rechs Stabilisatorstang/Stabilizer rod/Diagonalstrebe	Quattro Ø10 mm. 230 mm.	

POS	A4 (8EC) 11/04- & A4 Avant (8ED) 11/04-
Foraksel/Front axle/Vorneachse	
1	5004774 V/H - L/R Styrestang/Steering rod/Spurstange
2	5114737 Venstre/Left/Links Stabilisatorstang/Stabilizer rod/Diagonalstrebe
3	5114738 Højre/Right/Rechs Stabilisatorstang/Stabilizer rod/Diagonalstrebe
POS	A6 (4A, C4) 6/94-2/97 & A6 Avant (4A, C4) 6/94-12/97 & A6 Quattro (4A, C4) 6/94-12/97
Foraksel/Front axle/Vorneachse	
1	5004746 Venstre/Left/Links Styrestang/Steering rod/Spurstange
2	5004747 Højre/Right/Rechs Styrestang/Steering rod/Spurstange
3	5004781 V/H - L/R Styrestang/Steering rod/Spurstange
4	5014713 Venstre/Left/Links Bærearmlenke/Track control arm/Querlenker
5	5014714 Højre/Right/Rechs Bærearmlenke/Track control arm/Querlenker
6	5034730 Venstre/Left/Links Styrekugle/Tie rod end/Kugelgelenk
7	5034731 Højre/Right/Rechs Styrekugle/Tie rod end/Kugelgelenk
8	5094712 Manchetsæt/Boot kit/Manschetten satz
9	5104718 V/H - L/R Bøsning/Bushing/Buchsen
10	5104719 V/H - L/R (2 Stk.i hver side/2 Pcs in each side/2 Stück. in jeder seite) Bøsning/Bushing/Buchsen



AUDI

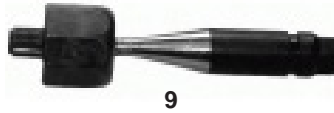

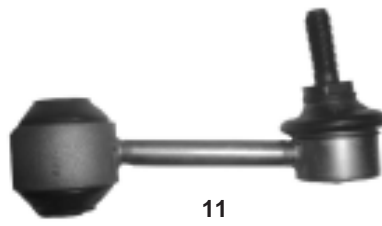









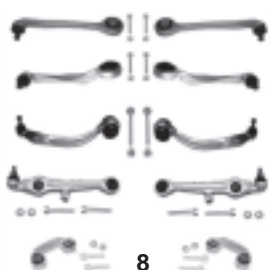

POS	A6 (4A, C4) 6/94-2/97 & A6 Avant (4A, C4) 6/94-12/97 & A6 Quattro (4A, C4) 6/94-12/97
11	5114717 Venstre/Left/Links 90 mm. (Aluminium) Stabilisatorstang/Stabilizer rod/Diagonalstrebe Yderste/Outer/Außen
12	5114718 Højre/Right/Rechs 90 mm. (Aluminium) Stabilisatorstang/Stabilizer rod/Diagonalstrebe Yderste(Outer/Außen)
Bagaksel/Rear axle/Hinterachse	
13	5114736 V/H - L/R Stabilisator bolt/Stabilizer bolt/Stabilisator bolzen
POS	A6 (4B, C5) 2/97-
21	5114747 V/H - L/R Stabilisatorstang/Stabilizer rod/Diagonalstrebe Foraksel/Front axle/Vorneachse
1	5004774 V/H - L/R Styrestang/Steering rod/Spurstange
2	5014716 For/Front/Vorne Bærearmlenke/Track control arm/Querlenker
3	5014719 Bag/Rear/Hinten Bærearmlenke/Track control arm/Querlenker
4	5014720 Bag/Rear/Hinten Bærearmlenke/Track control arm/Querlenker
5	5014727 For/Front/Vorne Bærearmlenke/Track control arm/Querlenker
6	5014728 For/Front/Vorne Bærearmlenke/Track control arm/Querlenker
7	5014733 Bag/Rear/Hinten Bærearmlenke/Track control arm/Querlenker
8	5014734 Bag/Rear/Hinten Bærearmlenke/Track control arm/Querlenker
9	5014747 For/Front/Vorne Bærearmlenke/Track control arm/Querlenker
10	5014738 V/H - L/R

POS		A6 (4B, C5) 2/97-	
		Bæream/Track control arm/Querlenker	
		Foraksel/Front axle/Vorneachse	
11		5014747 For/Front/Vorne Bæream/Track Control arm/Querlenker	Nederste/Lower/Unten
			 11
			 12
12		5034755 V/H - L/R Styrekugle/Tie rod end/Axialgelenk	14x1,5 RHT Inderste/Inner
13		5034756 V/H - L/R Styrekugle/Tie rod end/Kugelgelenk	14x1,5 RHT Yderste/Outer/Außen
			 13
			 14
			 15
14		5104714 For/Front/Vorne Bøsning/Bushing/Buchsen	V/H - L/R
15		5104715 Bag/Rear/Hinten Bøsning/Bushing/Buchsen	V/H - L/R
			 16
			 17
16		5104716 V/H - L/R Bøsning/Bushing/Buchsen	Nederste/Lower/Unten
17		5104717 V/H - L/R Bøsning/Bushing/Buchsen	Øverste/Upper/Oben
			 18
			 19
18		5114705 V/H - L/R Stabilisatorstang/Stabilizer rod/Diagonalstrebe	70 mm. CH -4BW100000
19		5114717 Venstre/Left/Links Stabilisatorstang/Stabilizer rod/Diagonalstrebe	90 mm. (Aluminium) CH 4BW100001-
20		5114718 Højre/Right/Rechs Stabilisatorstang/Stabilizer rod/Diagonalstrebe	90 mm. (Aluminium) CH 4BW100001-
			 20
POS			
		Bagaksel/Rear axle/Hinterachse	
21		5114748 V/H - L/R Stabilisator/Stabilizer/Stabilisato	62,5
			 21



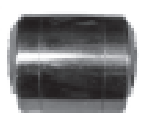

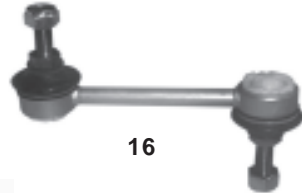



POS	 A6 (4F2, 4F5) 5/04-
Foraksel/Front axle/Vorneachse	
1	<p>XXXXXX For/Front/Vorne V/H - L/R Bærearml/Track control arm/Querlenker Nederste/Lower/Unten</p>
2	<p>XXXXXX Bag/Rear/Hinten Venstre/Left/Links Bærearml/Track control arm/Querlenker Øverste/Upper/Oben</p>
3	<p>XXXXXX Bag/Rear/Hinten Højre/Right/Rechs Bærearml/Track control arm/Querlenker Øverste/Upper/Oben</p>
4	<p>XXXXXX For/Front/Vorne Venstre/Left/Links Bærearml/Track control arm/Querlenker Øverste/Upper/Oben</p>
5	<p>XXXXXX For/Front/Vorne Højre/Right/Rechs Bærearml/Track control arm/Querlenker Øverste/Upper/Oben</p>
6	<p>XXXXXX Bag/Rear/Hinten Venstre/Left/Links Bærearml/Track control arm/Querlenker Nederste/Lower/Unten</p>
7	<p>XXXXXX Bag/Rear/Hinten Højre/Right/Rechs Bærearml/Track control arm/Querlenker Nederste/Lower/Unten</p>
8	<p>5034786 V/H - L/R 14x1,5 RHT Styrekugle/Tie rod end/Kugelgelenk</p>
9	<p>5034787 V/H - L/R 141 mm. 14x1,5 RHT Styrekugle/Tie rod end/Axialgelenk</p>
10	<p>5114749 V/H - L/R 110 mm. Stabilisator/Stabilizer/Stabilisator</p>
 <p style="text-align: center;">8</p>	
 <p style="text-align: center;">9</p>	
 <p style="text-align: center;">10</p>	
POS	
Bagaksel/Rear axle/Hinterachse	
11	<p>5114750 V/H - L/R 100 mm. Stabilisator/Stabilizer/Stabilisator</p>
 <p style="text-align: center;">11</p>	

AUDI



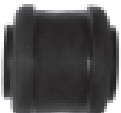





POS	
POS	

POS	A8 (4D2, 4D8) 3/94- & A8 Quattro (4D2, 4D8) 3/94-		
		Foraksel/Front axle/Vorneachse	
1	5004774 V/H - L/R Styrestang/Steering rod/Spurstange		 1
2	5014716 For/Front/Vorne Bæream/Track control arm/Querlenker	V/H - L/R Nederste/Lower/Unten	 2
3	5014719 Bag/Rear/Hinten Bæream/Track control arm/Querlenker	Venstre/Left/Links Nederste/Lower/Unten	 3
4	5014720 Bag/Rear/Hinten Bæream/Track control arm/Querlenker	Højre/Right/Rechs Nederste/Lower/Unten	 4
5	5014729 For/Front/Vorne Bæream/Track control arm/Querlenker	V/H - L/R Øverste/Upper/Oben	 5
6	5014733 Bag/Rear/Hinten Bæream/Track control arm/Querlenker	Venstre/Left/Links Øverste/Upper/Oben	 6
7	5014734 Bag/Rear/Hinten Bæream/Track control arm/Querlenker	Højre/Right/Rechs Øverste/Upper/Oben	 7
8	5014738 V/H - L/R Rep. sæt Bæream/Repair kit track control arm/ Reparatursatz Querlenker		 8
9	5034755 V/H - L/R Styrekugle/Tie rod end/Axialgelenk	14x1,5 RHT Inderste/Inner	 9
10	5034756 V/H - L/R Styrekugle/Tie rod end/Kugelgelenk	14x1,5 RHT Yderste/Outer/Außen	 10
11	5104714 For/Front/Vorne Bøsning/Bushing/Buchsen	V/H - L/R	 11
POS			
12	5104715 Bag/Rear/Hinten Bøsning/Bushing/Buchsen	V/H - L/R	 12
13	5104716 V/H - L/R Bøsning/Bushing/Buchsen	Nederste/Lower/Unten	 13
14	5104717 V/H - L/R Bøsning/Bushing/Buchsen	Øverste/Upper/Oben	 14
15	5114705 V/H - L/R Stabilisatorstang/Stabilizer rod/Diagonalstrebe	70 mm.	 15
	Bagaksel/Rear axle/Hinterachse		 16
16	5114710 V/H - L/R Stabilisatorstang/Stabilizer rod/Diagonalstrebe	120 mm.	 17
17	5114721 Venstre/Left/Links Stabilisator/Stabilizer/Stabilisator	Ø12 mm. 61 mm.	 18
18	5114722 Højre/Right/Rechs Bæream/Track control arm/Querlenker		

POS	V8 10/88-2/94
Foraksel/Front axle/Vorneachse	
1	5014711 Venstre/Left/Links Konus/Cone 19 mm.(**) Bærearmlenke/Track control arm/Querlenker
2	5014712 Højre/Right/Rechs Konus/Cone 19 mm.(**) Bærearmlenke/Track control arm/Querlenker
3	5034730 Venstre/Left/Links 16x1,5 RHT Styrekugle/Tie rod end/Kugelgelenk Yderste/Outer/Außen
4	5034731 Højre/Right/Rechs 16x1,5 RHT Styrekugle/Tie rod end/Kugelgelenk Yderste/Outer/Außen
5	5094712 Manchetsæt/Boot kit/Manschetten satz
6	5114749 V/H - L/R 110 mm. Stabilisator/Stabilizer/Stabilisator
POS	TT (8N3 & 8N9) 10/98-
Foraksel/Front axle/Vorneachse	
1	5104736 Bag/Rear/Hinten V/H - L/R Bøsning/Bushing/Buchsen















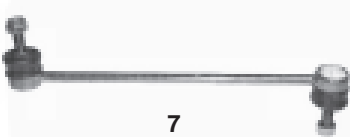

POS	50 1975-78			
Foraksel/Front axle/Vorneachse				
1	5004706 U	Venstre/Left/Links	CH 8662300001-86/87C200000	 1
		Styrestang/Steering rod/Spurstange		
2	5014702 U	V/H - L/R	CH 865 15000 000-868 2600 000	 2
		Bærearmlenke/Track control arm/Querlenker	Ø14 mm.	
3	5024701		CH 865 15000 000-868 2600 000	
		Tandstang/Steering rack/Zahnstange		
4	5034712	V/H - L/R	CH 865 15000 000-868 2600 000	 3
		Styrekugle/Tie rod end/Kugelgelenk	Yderste/Outer/Außen	14x1,5 RHT
5	5104721	For/Front/Vorne	V/H - L/R	 4
		Bøsning/Bushing/Buchsen	CH 8662300001-86/87C200000	
6	5104722	Bag/Rear/Hinten	V/H - L/R	 5
		Bøsning/Bushing/Buchsen	CH 8662300001-86/87C200000	 6
POS	80 (- Aut.) 5/72-7/78 & 80 (- Aut.)- 8/77 & 80 (- Aut.) 9/77-			
Foraksel/Front axle/Vorneachse				
1	5004713 U	V/H - L/R	CH 865 15000 001-868 2600 000	 1
		Styrestang/Steering rod/Spurstange		
2	5034712	V/H - L/R	CH 865 15000 001-868 2600 000	 2
		Styrekugle/Tie rod end/Kugelgelenk	Yderste/Outer/Außen	14x1,5 RHT
3	5044711	V/H - L/R	CH 865 15000 001-868 2600 000	 3
		Bærekugle/Ball joint/Radgelenk	Nederste/Lower/Unten	Konus/Cone 17 mm.

POS	80 (81) 8/78-3/80			
		Foraksel/Front axle/Vorneachse		
1	5034712 V/H - L/R Styrekugle/Tie rod end/Kugelgelenk	14x1,5 RHT Yderste/Outer/Außen		1
2	5044711 V/H - L/R Bærekugle/Ball joint/Radgelenk	Konus/Cone 17 mm. Nederste/Lower/Unten		2
POS	80 (81) 4/80-7/84			
		Foraksel/Front axle/Vorneachse		
1	5004714 Venstre/Left/Links Styrestang/Steering rod/Spurstange	CH 81A 0173 589-81E 220 000		1
2	5004715 Højre/Right/Rechs Styrestang/Steering rod/Spurstange	CH 81A 0173 589-81E 220 000		2
3	5034712 V/H - L/R Styrekugle/Tie rod end/Kugelgelenk	CH -81B 095 000 14x1,5 RHT Yderste/Outer/Außen		3
4	5034720 V/H - L/R Styrekugle/Tie rod end/Kugelgelenk	CH 81B 095 001- 14x1,5 RHT Yderste/Outer/Außen		4
5	5044711 V/H - L/R Bærekugle/Ball joint/Radgelenk	CH 81A 0173 589-81E 220 000 Konus/Cone 17 mm. (*) Nederste/Lower/Unten		5
6	5104701 Bag/Rear/Hinten Bøsning/Bushing/Buchsen	V/H - L/R CH 81A 0173 589- (*)		6
7	5104701 Bag/Rear/Hinten Bøsning/Bushing/Buchsen	V/H - L/R CH -81D077973 (**)		7
8	5104702 Bag/Rear/Hinten Bøsning/Bushing/Buchsen	V/H - L/R CH 81D077974-		8
		(*)	Uden Servo Styling Without Power Steering Ohne Servolenkung	
		(**)	Med Servo Styling With Power Steering Mit Servolenkung	

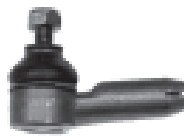
POS	80 (81) 6/84-3/87	
Foraksel/Front axle/Vorneachse		
1	5004714 Venstre/Left/Links CH 81F 000 001-81H 299 000 Styrestang/Steering rod/Spurstange	 1
2	5004715 Højre/Right/Rechs CH -81G 160 000 Styrestang/Steering rod/Spurstange	 2
3	5004733 Højre/Right/Rechs CH 81G 160 001- Styrestang/Steering rod/Spurstange	 3
4	5034720 V/H - L/R CH 81F 000 001-81H 299 000 14x1,5 RHT Styrekugle/Tie rod end/Kugelgelenk Yderste/Outer/Außen	 4
5	5044711 V/H - L/R CH 81F 000 001-81H 299 000 Konus/Cone 17 mm. (*) Bærekugle/Ball joint/Radgelenk Nederste/Lower/Unten	 5
(*) Uden Servo Styling Without Power Steering Ohne Servolenkung		
POS	80 Quattro (85) 8/82-8/86	
Foraksel/Front axle/Vorneachse		
1	5004714 Venstre/Left/Links Styrestang/Steering rod/Spurstange	 1
2	5004715 Højre/Right/Rechs CH -81G 160 000 Styrestang/Steering rod/Spurstange	 2
3	5004733 Højre/Right/Rechs CH 81G 160 001- Styrestang/Steering rod/Spurstange	 3
4	5034720 V/H - L/R 14x1,5 RHT Styrekugle/Tie rod end/Kugelgelenk Yderste/Outer/Außen	 4









POS	80 (89) 9/86-7/89				
		Foraksel/Front axle/Vorneachse			
1	5004714	Venstre/Left/Links	CH 89H 300 001-89K 420 000		1
		Styrestang/Steering rod/Spurstange			
2	5004744	Højre/Right/Rechs	CH 89H 300 001-89K 420 000		2
		Styrestang/Steering rod/Spurstange			
3	5034720	V/H - L/R	CH 89H 300 001-89K 420 000	14x1,5 RHT	
		Styrekugle/Tie rod end/Kugelgelenk		Yderste/Outer/Außen	
4	5044721	Venstre/Left/Links	CH -89J 373 598 (*)		3
		Bærekugle/Ball joint/Radgelenk		Nederste/Lower/Unten	4
5	5044722	Højre/Right/Rechs	CH -89J 373 598 (*)		5
		Bærekugle/Ball joint/Radgelenk		Nederste/Lower/Unten	6
6	5044723	Venstre/Left/Links	CH 89J 373 599-	Konus/Cone 19 mm.	(*)
		Bærekugle/Ball joint/Radgelenk		Nederste/Lower/Unten	
7	5044724	Højre/Right/Rechs	CH 89J 373 599-	Konus/Cone 19 mm.	(*)
		Bærekugle/Ball joint/Radgelenk		Nederste/Lower/Unten	7
8	5044735	Venstre/Left/Links	CH 89H 300 001-	CH -89K 420 000 (**)	
		Bærekugle/Ball joint/Radgelenk		Nederste/Lower/Unten	8
9	5044736	Højre/Right/Rechs	CH 89H 300 001-	CH -89K 420 000 (**)	
		Bærekugle/Ball joint/Radgelenk		Nederste/Lower/Unten	9
POS	80 (89) 8/89-7/91				
		Foraksel/Front axle/Vorneachse			
1	5004714	Venstre/Left/Links	CH 8AL 000 001-		1
		Styrestang/Steering rod/Spurstange			
2	5004744	Højre/Right/Rechs	CH 8AL 000 001-		2
		Styrestang/Steering rod/Spurstange			
3	5034720	V/H - L/R	CH 8AL 000 001-	14x1,5 RHT	
		Styrekugle/Tie rod end/Kugelgelenk		Yderste/Outer/Außen	
4	5044723	Venstre/Left/Links	CH 8AL 000 001-	Konus/Cone 19 mm. (*)	
		Bærekugle/Ball joint/Radgelenk		Nederste/Lower/Unten	3
5	5044724	Højre/Right/Rechs	CH 8AL 000 001-	Konus/Cone 19 mm. (*)	
		Bærekugle/Ball joint/Radgelenk		Nederste/Lower/Unten	4
6	5044740	Venstre/Left/Links	CH 8AL 000 001-	(**)	
		Bærekugle/Ball joint/Radgelenk		Nederste/Lower/Unten	5
7	5044741	Højre/Right/Rechs	CH 8AL 000 001-	(**)	
		Bærekugle/Ball joint/Radgelenk		Nederste/Lower/Unten	6
8	5114745	V/H - L/R	CH 8AL 045 000-		8
		Stabilisatorstang/Stabilizer rod/Diagonalstrebe			
				(*)	Uden Servo Styling
					Without Power Steering
					Ohne Servolenkung
				(**)	Med Servo Styling
					With Power Steering
					Mit Servolenkung



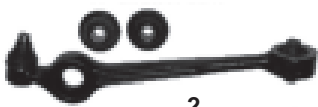

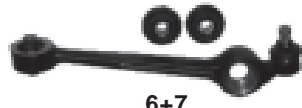
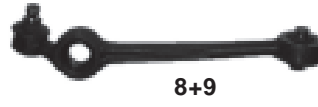
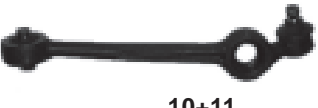

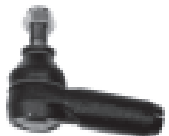

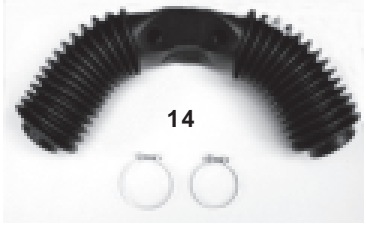
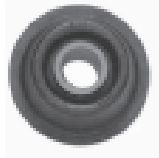

POS	80 Quattro (89Q) 9/86-8/91				
		Foraksel/Front axle/Vorneachse			
1	5004714 Venstre/Left/Links Styrestang/Steering rod/Spurstange		1		
2	5004744 Højre/Right/Rechs Styrestang/Steering rod/Spurstange		2		
3	5034720 V/H - L/R Styrekugle/Tie rod end/Kugelgelenk	14x1,5 RHT Yderste/Outer/Außen			3
4	5044723 Venstre/Left/Links Bærekugle/Ball joint/Radgelenk	Konus/Cone 19 mm. Nederste/Lower/Unten	4		5
5	5044724 Højre/Right/Rechs Bærekugle/Ball joint/Radgelenk	Konus/Cone 19 mm. Nederste/Lower/Unten	5		6
6	5044740 Venstre/Left/Links Bærekugle/Ball joint/Radgelenk	7/89 - 9/91 (**) Nederste/Lower/Unten	5		6
7	5044741 Højre/Right/Rechs Bærekugle/Ball joint/Radgelenk	7/89 - 9/91 (**) Nederste/Lower/Unten	7		8
8	5104701 Bag/Rear/Hinten Bøsning/Bushing/Buchsen	V/H - L/R (*)	7		8
9	5104702 Bag/Rear/Hinten Bøsning/Bushing/Buchsen	V/H - L/R (**)	(*)		9
10	5114745 V/H - L/R Stabilisatorstang/Stabilizer rod/Diagonalstrebe		(*)		(**)
					Uden Servo Styling Without Power Steering Ohne Servolenkung
					Med Servo Styling With Power Steering Mit Servolenkung
POS	80 (B4) 9/91-12/94				
		Foraksel/Front axle/Vorneachse			
1	5004714 Venstre/Left/Links Styrestang/Steering rod/Spurstange	CH 8CN 000 001-	1		
2	5004744 Højre/Right/Rechs Styrestang/Steering rod/Spurstange	CH 8CN 000 001-	2		
3	5014730 For/Front/Vorne Bærearmlenke/Track control arm/Querlenker	Venstre/Left/Links CH 8CN 000 001-			
4	5014731 For/Front/Vorne Bærearmlenke/Track control arm/Querlenker	Højre/Right/Rechs CH 8CN 000 001-			
5	5034720 V/H - L/R Styrekugle/Tie rod end/Kugelgelenk	CH 8CN 000 001- 14x1,5 RHT Yderste/Outer/Außen			3
6	5044729 Venstre/Left/Links Bærekugle/Ball joint/Radgelenk	CH 8CN 000 001- Konus/Cone 19 mm. Nederste/Lower/Unten			4
7	5044730 Højre/Right/Rechs Bærekugle/Ball joint/Radgelenk	CH 8CN 000 001- Konus/Cone 19 mm. Nederste/Lower/Unten			5
8	5104702 Bag/Rear/Hinten Bøsning/Bushing/Buchsen	V/H - L/R CH 8CN 000 001-			6
9	5114745 V/H - L/R Stabilisatorstang/Stabilizer rod/Diagonalstrebe	CH 8CN 000 001-	7		8
					9

POS	80 Avant (B4) 9/91-1/96 & 80 Avant Quattro (B4) 9/91-
Foraksel/Front axle/Vorneachse	
1	5004714 Venstre/Left/Links Styrestang/Steering rod/Spurstange  1
2	5004744 Højre/Right/Rechs Styrestang/Steering rod/Spurstange  2
3	5034720 V/H - L/R Styrekugle/Tie rod end/Kugelgelenk 14x1,5 RHT Yderste/Outer/Außen  3
4	5044729 Venstre/Left/Links Bærekugle/Ball joint/Radgelenk Konus/Cone 19 mm. Nederste/Lower/Unten  4
5	5044730 Højre/Right/Rechs Bærekugle/Ball joint/Radgelenk Konus/Cone 19 mm. Nederste/Lower/Unten  5
6	5104702 Bag/Rear/Hinten Bøsning/Bushing/Buchsen V/H - L/R  6
7	5114745 V/H - L/R Stabilisatorstang/Stabilizer rod/Diagonalstrebe  7
Bagaksel/Rear axle/Hinterachse	
8	5114708 Venstre/Left/Links Ø10 mm. 230 mm. Stabilisatorstang/Stabilizer rod/Diagonalstrebe  8
9	5114709 Højre/Right/Rechs Ø10 mm. 230 mm. Stabilisatorstang/Stabilizer rod/Diagonalstrebe  9
POS	80 Quattro (B4) 9/91-12/94
Foraksel/Front axle/Vorneachse	
1	5004714 Venstre/Left/Links Styrestang/Steering rod/Spurstange  1
2	5004744 Højre/Right/Rechs Styrestang/Steering rod/Spurstange  2
3	5034720 V/H - L/R Styrekugle/Tie rod end/Kugelgelenk 14x1,5 RHT Yderste/Outer/Außen  3
4	5044729 Venstre/Left/Links Bærekugle/Ball joint/Radgelenk Konus/Cone 19 mm. Nederste/Lower/Unten  4
5	5044730 Højre/Right/Rechs Bærekugle/Ball joint/Radgelenk Konus/Cone 19 mm. Nederste/Lower/Unten  5
6	5104702 Bag/Rear/Hinten Bøsning/Bushing/Buchsen V/H - L/R  6
7	5114745 V/H - L/R Stabilisatorstang/Stabilizer rod/Diagonalstrebe  7
Bagaksel/Rear axle/Hinterachse	
8	5114708 Venstre/Left/Links Ø10 mm. 230 mm. Stabilisatorstang/Stabilizer rod/Diagonalstrebe  8
9	5114709 Højre/Right/Rechs Ø10 mm. 230 mm. Stabilisatorstang/Stabilizer rod/Diagonalstrebe  9

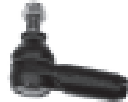



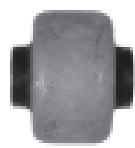
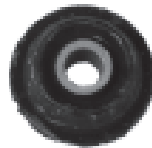







POS	90 (89) 4/87-7/91			
		Foraksel/Front axle/Vorneachse		
1	5004714 Venstre/Left/Links Styrestang/Steering rod/Spurstange		1	
2	5004715 Højre/Right/Rechs Styrestang/Steering rod/Spurstange		2	
3	5034720 V/H - L/R Styrekugle/Tie rod end/Kugelgelenk	14x1,5 RHT Yderste/Outer/Außen		3
4	5044721 Venstre/Left/Links Bærekugle/Ball joint/Radgelenk	CH -89J 373 598 (*) Nederste/Lower/Unten		4
5	5044723 Venstre/Left/Links Bærekugle/Ball joint/Radgelenk	Konus/Cone 19 mm.(*) CH -89J 373 598 Nederste/Lower/Unten		5
6	5044724 Højre/Right/Rechs Bærekugle/Ball joint/Radgelenk	Konus/Cone 19 mm.(*) CH 89J 373 599- Nederste/Lower/Unten		6
7	5104701 Bag/Rear/Hinten Bøsning/Bushing/Buchsen	V/H - L/R (*)		7
8	5104702 Bag/Rear/Hinten Bøsning/Bushing/Buchsen	V/H - L/R (**)		8
9	5114745 V/H - L/R Stabilisatorstang/Stabilizer rod/Diagonalstrebe	CH 8AL 045 001-		9
POS	90 Quattro (89Q) 4/87-9/91			
		Foraksel/Front axle/Vorneachse		
1	5004714 Venstre/Left/Links Styrestang/Steering rod/Spurstange		1	
2	5004715 Højre/Right/Rechs Styrestang/Steering rod/Spurstange		2	
3	5034720 V/H - L/R Styrekugle/Tie rod end/Kugelgelenk	14x1,5 RHT Yderste/Outer/Außen		3
4	5044735 Venstre/Left/Links Bærekugle/Ball joint/Radgelenk	7/87 - 7/89 (**) Nederste/Lower/Unten		4
5	5044736 Højre/Right/Rechs Bærekugle/Ball joint/Radgelenk	7/87 - 7/89 (**) Nederste/Lower/Unten		5
6	5044740 Venstre/Left/Links Bærekugle/Ball joint/Radgelenk	7/89 - 7/91 (**) Nederste/Lower/Unten		6
7	5044741 Højre/Right/Rechs Bærekugle/Ball joint/Radgelenk	7/89 - 7/91 (**) Nederste/Lower/Unten		7
8	5104702 Bag/Rear/Hinten Bøsning/Bushing/Buchsen	V/H - L/R (**)		8
			(*)	Uden Servo Styling Without Power Steering Ohne Servolenkung
			(**)	Med Servo Styling With Power Steering Mit Servolenkung

POS	100 (43) 8/76-7/82			
Foraksel/Front axle/Vorneachse				
1	5014706 Venstre/Left/Links Bærearmlenke/Track control arm/Querlenker	CH 43C 007001- (*)		1
2	5014707 Højre/Right/Rechs Bærearmlenke/Track control arm/Querlenker	CH 43C 007001- (*)		2
3	5014708 Venstre/Left/Links Bærearmlenke/Track control arm/Querlenker	Konus/Cone 18 mm. (**) CH 43C 022303-		3
4	5014709 Højre/Right/Rechs Bærearmlenke/Track control arm/Querlenker	Konus/Cone 18 mm. (**) CH 43C 022303-		4
5	5104733 For/Front/Vorne Bøsning/Bushing/Buchsen	V/H - L/R		5
POS 100 Avant (43) 7/77-2/83 & 100 Avant (43) 1.6/2.0/2.2 & 2.0 D 7/77-2/83				
Foraksel/Front axle/Vorneachse				
1	5004731 Højre/Right/Rechs Styrestang/Steering rod/Spurstange	CH 43D 000001-		1
2	5014706 Venstre/Left/Links Bærearmlenke/Track control arm/Querlenker	CH 43C 007001- (*)		2
3	5014707 Højre/Right/Rechs Bærearmlenke/Track control arm/Querlenker	CH 43C 007001- (*)		3
4	5014708 Venstre/Left/Links Bærearmlenke/Track control arm/Querlenker	Konus/Cone 18 mm. (**) CH 43C 022303-		4
5	5014709 Højre/Right/Rechs Bærearmlenke/Track control arm/Querlenker	Konus/Cone 18 mm. (**) CH 43C 022303-		5
6	5034728 Venstre/Left/Links Styrekugle/Tie rod end/Kugelgelenk	14x1,5 RHT CH - 44D 068500 Yderste/Outer/Außen		6
7	5034729 Højre/Right/Rechs Styrekugle/Tie rod end/Kugelgelenk	14x1,5 RHT CH - 44D 068500 Yderste/Outer/Außen		7
8	5034730 Venstre/Left/Links Styrekugle/Tie rod end/Kugelgelenk	16x1,5 RHT CH 44D 068501- Yderste/Outer/Außen		8
9	5034731 Højre/Right/Rechs Styrekugle/Tie rod end/Kugelgelenk	16x1,5 RHT CH 44D 068501- Yderste/Outer/Außen		9
10	5104733 For/Front/Vorne Bøsning/Bushing/Buchsen	V/H - L/R		10
		(*)	Uden Servo Styling Without Power Steering Ohne Servolenkung	
		(**)	Med Servo Styling With Power Steering Mit Servolenkung	





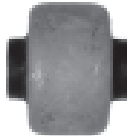





POS		100 Avant Quattro (44Q)	8/84-11/90 & 100 Quattro (44Q)	8/84-11/90
Foraksel/Front axle/Vorneachse				
1	5004731 U Højre/Right/Rechs Styrestang/Steering rod/Spurstange			1
2	5014706 Venstre/Left/Links CH -44G 024418 (*) Bærearmlenke/Track control arm/Querlenker			2
3	5014707 Højre/Right/Rechs CH -44G 024418 (*) Bærearmlenke/Track control arm/Querlenker			3
4	5014708 Venstre/Left/Links Konus/Cone 18 mm. Bærearmlenke/Track control arm/Querlenker			4+5
5	5014708 Venstre/Left/Links Konus/Cone 18 mm. (2.2) CH. -44L 111380/-44M 017381 (") Bærearmlenke/Track control arm/Querlenker			
6	5014709 Højre/Right/Rechs Konus/Cone 18 mm. Bærearmlenke/Track control arm/Querlenker			6+7
7	5014709 Højre/Right/Rechs Konus/Cone 18 mm. (2.2) CH. -44L 111380/-44M 017381 (") Bærearmlenke/Track control arm/Querlenker			
8	5014711 Venstre/Left/Links Konus/Cone 19 mm. Bærearmlenke/Track control arm/Querlenker			8+9
9	5014711 Venstre/Left/Links Konus/Cone 19 mm. (2.2) CH. 44L 111381/-44M 017382- (") Bærearmlenke/Track control arm/Querlenker			
10	5014712 Højre/Right/Rechs Konus/Cone 19 mm. Bærearmlenke/Track control arm/Querlenker			10+11
11	5014712 Højre/Right/Rechs Konus/Cone 19 mm. (2.2) CH. 44L 111381/-44M 017382- (") Bærearmlenke/Track control arm/Querlenker			
POS				
12	5034730 Venstre/Left/Links 16x1,5 RHT Styrekugle/Tie rod end/Kugelgelenk	Yderste/Outer/Außen		12
13	5034731 Højre/Right/Rechs 16x1,5 RHT Styrekugle/Tie rod end/Kugelgelenk	Yderste/Outer/Außen		13
14	5094712 Manchetsæt/Boot kit/Manschetten satz			
15	5104733 For/Front/Vorne V/H - L/R Bøsning/Bushing/Buchsen			14
				15
			(*)	Uden Servo Styling Without Power Steering Ohne Servolenkung
			(**)	Med Servo Styling With Power Steering Mit Servolenkung





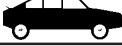

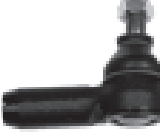
POS	100 (C4) 12/90-6/94 & 100 Avant (C4) 9/91-6/94
Foraksel/Front axle/Vorneachse	
1	5004746 Venstre/Left/Links CH 4A0 P 001984- Styrestang/Steering rod/Spurstange  1
2	5004747 Højre/Right/Rechs CH 4A0 P 001984- Styrestang/Steering rod/Spurstange  2
3	5014713 Venstre/Left/Links Bærearml/Track control arm/Querlenker Nederste/Lower/Unten  3
4	5014714 Højre/Right/Rechs Bærearml/Track control arm/Querlenker Nederste/Lower/Unten  4
5	5034730 Venstre/Left/Links CH 4A0 P 001984- 16x1,5 RHT Styrekugle/Tie rod end/Kugelgelenk Yderste/Outer/Außen  5
6	5034731 Højre/Right/Rechs CH 4A0 P 001984- 16x1,5 RHT Styrekugle/Tie rod end/Kugelgelenk Yderste/Outer/Außen  6
7	5034742 Venstre/Left/Links CH -4A0 P 001983 18x1,5 RHT Styrekugle/Tie rod end/Kugelgelenk Yderste/Outer/Außen  7
8	5034743 Højre/Right/Rechs CH -4A0 P 001983 18x1,5 RHT Styrekugle/Tie rod end/Kugelgelenk Yderste/Outer/Außen  8
9	5094712 Manchetsæt/Boot kit/Manschetten satz  9
10	5104718 V/H - L/R Bøsning/Bushing/Buchsen Inderste/Inner/Innen  10
11	5104719 V/H - L/R 2 Stk./Pcs./Stück Bøsning/Bushing/Buchsen Yderste/Outer/Außen  11
Bagaksel/Rear axle/Hinterachse	
12	5114736 V/H - L/R 2 stk./Pcs./Stück Stabilisator bolt/Stabilizer bolt/Stabilisator bolzen  12+13
13	5114736 V/H - L/R CH 4A0 P 001984- Stabilisator bolt/Stabilizer bolt/Stabilisator bolzen
	(*) Uden Servo Styling Without Power Steering Ohne Servolenkung
	(**) Med Servo Styling With Power Steering Mit Servolenkung

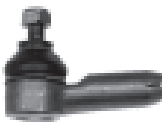

POS	100 Quattro (C4) 12/90-6/94			
Foraksel/Front axle/Vorneachse				
1	5004746 Venstre/Left/Links Styrestang/Steering rod/Spurstange	CH 4A0 P 000001-		1
2	5004747 Højre/Right/Rechs Styrestang/Steering rod/Spurstange	CH 4A0 P 000001-		2
3	5014713 Venstre/Left/Links Bærearml/Track control arm/Querlenker	Nederste/Lower/Unten		3
4	5014714 Højre/Right/Rechs Bærearml/Track control arm/Querlenker	Nederste/Lower/Unten		4
5	5034730 Venstre/Left/Links 2.3 E/2.6 E CH 4A0 N 250000- Styrekugle/Tie rod end/Kugelgelenk	16x1,5 RHT (2.0 E/2.8 E) CH 4A0 P 000001- Yderste/Outer/Außen		5+6
6	5034730 Venstre/Left/Links Styrekugle/Tie rod end/Kugelgelenk	16x1,5 RHT (2.3 E/2.6 E) CH 4A0 N 250000- Yderste/Outer/Außen		7+8
7	5034731 Højre/Right/Rechs Styrekugle/Tie rod end/Kugelgelenk	16x1,5 RHT (2.0 E/2.8 E) CH 4A0 P 000001- Yderste/Outer/Außen		9
8	5034731 Højre/Right/Rechs Styrekugle/Tie rod end/Kugelgelenk	16x1,5 RHT (2.3 E/2.6 E) CH 4A0 N 250000- Yderste/Outer/Außen		10
9	5034742 Venstre/Left/Links Styrekugle/Tie rod end/Kugelgelenk	CH -4A0 N 250000 18x1,5 RHT Yderste/Outer/Außen		11
10	5034743 Højre/Right/Rechs Styrekugle/Tie rod end/Kugelgelenk	CH -4A0 N 250000 18x1,5 RHT Yderste/Outer/Außen		11
11	5094712 Manchetsæt/Boot kit/Manschetten satz			
POS				
12	5104718 V/H - L/R Bøsning/Bushing/Buchsen	Inderste/Inner/Innen		12
13	5104719 V/H - L/R (2 Stk.i hver side/2 Pcs in each side/2 Stück. in jeder seite) Bøsning/Bushing/Buchsen	Yderste/Outer/Außen		13

POS	100 Avant Quattro (C4) 12/90-6/94
Foraksel/Front axle/Vorneachse	
1	5004746 Venstre/Left/Links (S4 2.2 Turbo/2.3 E/2.8 E/2.0 E) CH 4A0 P 000001- Styrestang/Steering rod/Spurstange  1
2	5004747 Højre/Right/Rechs (S4 2.2 Turbo/2.3 E/2.8 E/2.0 E) CH 4A0 P 000001- Styrestang/Steering rod/Spurstange  2
3	5014713 Venstre/Left/Links Bæream/Track control arm/Querlenker Nederste/Lower/Unten  3
4	5014714 Højre/Right/Rechs Bæream/Track control arm/Querlenker Nederste/Lower/Unten  4
5	5034730 Venstre/Left/Links 16x1,5 RHT (2.3 E/2.8 E/2.0 E) CH 4A0 P 000001- Styrekugle/Tie rod end/Kugelgelenk Yderste/Outer/Außen  5+6
6	5034730 Venstre/Left/Links 16x1,5 RHT (S4 2.2 Turbo) CH 4A0 P 000001- Styrekugle/Tie rod end/Kugelgelenk Yderste/Outer/Außen  7+8
7	5034731 Højre/Right/Rechs 16x1,5 RHT (2.3 E/2.8 E/2.0 E) CH 4A0 P 000001- Styrekugle/Tie rod end/Kugelgelenk Yderste/Outer/Außen  9
8	5034731 Højre/Right/Rechs 16x1,5 RHT (S4 2.2 Turbo) CH 4A0 P 000001- Styrekugle/Tie rod end/Kugelgelenk Yderste/Outer/Außen  10
9	5034742 Venstre/Left/Links 18x1,5 RHT CH -4A0 N 250000 Styrekugle/Tie rod end/Kugelgelenk Yderste/Outer/Außen  9
10	5034743 Højre/Right/Rechs CH -4A0 N 250000 18x1,5 RHT Styrekugle/Tie rod end/Kugelgelenk Yderste/Outer/Außen  10
11	5094712 Manchetsæt/Boot kit/Manschetten satz  11
POS	
12	5104718 V/H - L/R Bøsning/Bushing/Buchsen Inderste/Inner/Innen  12
13	5104719 V/H - L/R Bøsning/Bushing/Buchsen (2 Stk./Pcs./Stück) Yderste/Outer/Außen  13

POS	200 (43) 10/79-9/82			
Foraksel/Front axle/Vorneachse				
1	5014708 Venstre/Left/Links Bæream/Track control arm/Querlenker	Konus/Cone 18 mm. CH 43C 022303-		
2	5014709 Højre/Right/Rechs Bæream/Track control arm/Querlenker	Konus/Cone 18 mm. CH 43C 022303-		
3	5104733 For/Front/Vorne Bøsning/Bushing/Buchsen	V/H - L/R		
POS 200 (44) 8/83-12/91				
Foraksel/Front axle/Vorneachse				
1	5004731 U Højre/Right/Rechs Styrestang/Steering rod/Spurstange			
2	5014708 Venstre/Left/Links Bæream/Track control arm/Querlenker	Konus/Cone 18 mm.(**) CH -44M 017381		
3	5014709 Højre/Right/Rechs Bæream/Track control arm/Querlenker	Konus/Cone 18 mm.(**) CH -44M 017381		
4	5014711 Venstre/Left/Links Bæream/Track control arm/Querlenker	Konus/Cone 19 mm.(**) CH 44M 017382-		
5	5014712 Højre/Right/Rechs Bæream/Track control arm/Querlenker	Konus/Cone 19 mm.(**) CH 44M 017382-		
6	5034730 Venstre/Left/Links Styrekugle/Tie rod end/Kugelgelenk	16x1,5 RHT Yderste/Outer/Außen		
7	5034731 Højre/Right/Rechs Styrekugle/Tie rod end/Kugelgelenk	16x1,5 RHT Yderste/Outer/Außen		
8	5104733 For/Front/Vorne Bøsning/Bushing/Buchsen	V/H - L/R		
				<p>(**) Med Servo Styling With Power Steering Mit Servolenkung</p>

POS		200 Avant Quattro (44Q) 9/83-12/91 & 200 Quattro (44Q) 9/83-12/91
Foraksel/Front axle/Vorneachse		
1	5004731 U Højre/Right/Rechs Styrestang/Steering rod/Spurstange	 1
2	5014708 Venstre/Left/Links Konus/Cone 18 mm. (2.2 Turbo) CH -44L 111380 (**) Bærearmlenke/Track control arm/Querlenker	 2+3
3	5014708 Venstre/Left/Links Konus/Cone 18 mm. (2.2 Turbo) (ABS) CH -44M 017381 Bærearmlenke/Track control arm/Querlenker	
4	5014709 Højre/Right/Rechs Konus/Cone 18 mm. (2.2 Turbo) CH -44L 111380 (**) Bærearmlenke/Track control arm/Querlenker	 4+5
5	5014709 Højre/Right/Rechs Konus/Cone 18 mm. (2.2 Turbo) (ABS) CH -44M 017381 Bærearmlenke/Track control arm/Querlenker	
6	5014711 Venstre/Left/Links Konus/Cone 19 mm. (2.2 Turbo) CH 44L 111381- (**) Bærearmlenke/Track control arm/Querlenker	 6+7
7	5014711 Venstre/Left/Links Konus/Cone 19 mm. (2.2 Turbo) (ABS) CH 44M 017382- Bærearmlenke/Track control arm/Querlenker	
8	5014712 Højre/Right/Rechs Konus/Cone 19 mm. (2.2 Turbo) CH 44L 111381- (**) Bærearmlenke/Track control arm/Querlenker	 8+9
9	5014712 Højre/Right/Rechs Konus/Cone 19 mm. (2.2 Turbo) (ABS) CH 44M 017382- Bærearmlenke/Track control arm/Querlenker	
POS		
10	5034730 Venstre/Left/Links Styrekugle/Tie rod end/Kugelgelenk	16x1,5 RHT Yderste/Outer/Außen
11	5034731 Højre/Right/Rechs Styrekugle/Tie rod end/Kugelgelenk	16x1,5 RHT Yderste/Outer/Außen
12	5104733 For/Front/Vorne Bøsning/Bushing/Buchsen	V/H - L/R
		 10
		 11
		 12
Uden Servo Styling Without Power Steering Ohne Servolenkung		

POS	 Coupe Quattro III (85) 7/80-7/91
Foraksel/Front axle/Vorneachse	
1	<p>5034720 V/H - L/R 14x1,5 RHT Styrekugle/Tie rod end/Kugelgelenk Yderste/Outer/Außen</p>  <p style="text-align: center;">1</p>
POS	 Coupe Quattro IV (89Q) 8/89-
Foraksel/Front axle/Vorneachse	
1	<p>5004714 Venstre/Left/Links Styrestang/Steering rod/Spurstange</p>  <p style="text-align: center;">1</p>
2	<p>5004744 Højre/Right/Rechs Styrestang/Steering rod/Spurstange</p>  <p style="text-align: center;">2</p>
3	<p>5034720 V/H - L/R 14x1,5 RHT Styrekugle/Tie rod end/Kugelgelenk Yderste/Outer/Außen</p>  <p style="text-align: center;">3</p>
4	<p>5044729 Venstre/Left/Links Konus/Cone 19 mm. Bærekugle/Ball joint/Radgelenk Nederste/Lower/Unten</p>  <p style="text-align: center;">4</p>
5	<p>5044730 Højre/Right/Rechs Konus/Cone 19 mm. Bærekugle/Ball joint/Radgelenk Nederste/Lower/Unten</p>  <p style="text-align: center;">5</p>

POS	 1500/1502/1600/1600-2/1602/1800/1802/2000/2002
1	<p>Foraksel/Front axle/Vorneachse</p> <p>5111501 V/H - L/R 160 mm. Stabilisator bolt/Stabilizer bolt/Stabilisator bolzen</p> 
POS	

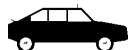

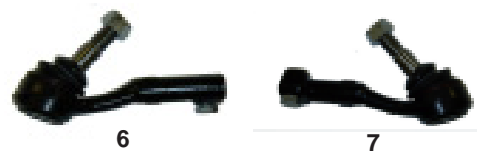













POS	 116i - 120d (E87) 9/04-
Foraksel/Front axle/Vorneachse	
1	5011539 Bag/Rear/Hinten Venstre/Left/Links Bærearml/Track control arm/Querlenker
2	5011540 Bag/Rear/Hinten Højre/Right/Rechs Bærearml/Track control arm/Querlenker
3	5011549 For/Front/Vorne Venstre/Left/Links Bærearml/Track control arm/Querlenker
4	5011550 For/Front/Vorne Højre/Right/Rechs Bærearml/Track control arm/Querlenker
5	5031520 V/H - L/R 14x1,5 RHT TRW Styrekugle/Tie rod end/Axialgelenk
6	5031527 Venstre/Left/Links 14x1,5 RHT TRW Styrekugle/Tie rod end/Kugelgelenk
7	5031528 Højre/Right/Rechs 14x1,5 RHT TRW Styrekugle/Tie rod end/Kugelgelenk
8	5111517 Venstre/Left/Links 293 mm. Stabilisatorstang/Stabilizer rod/Diagonalstrebe
9	5111518 Højre/Right/Rechs 293 mm. Stabilisatorstang/Stabilizer rod/Diagonalstrebe
Bagaksel/Rear axle/Hinterachse	
10	5101524 V/H - L/R Led/Joint/Gelenk
11	5111516 V/H - L/R Stabilisatorstang/Stabilizer rod/Diagonalstrebe
POS	

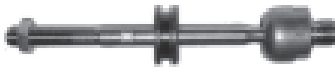

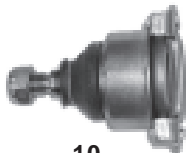

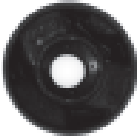



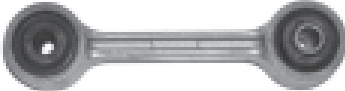

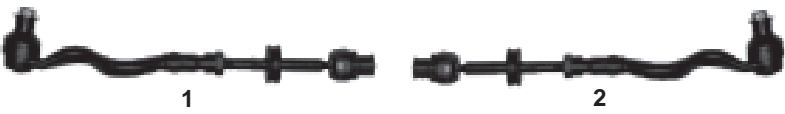

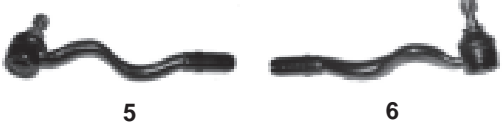

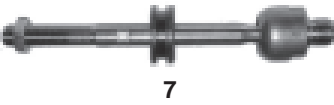

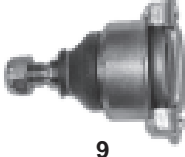
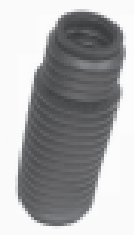

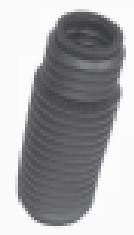

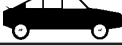



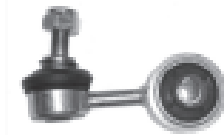
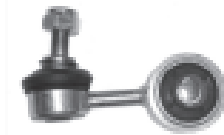

POS	315 - 323 i (E21) 8/75-3/84		
Foraksel/Front axle/Vorneachse			
1	5011502 Venstre/Left/Links 11/78 - Bærearmlenke/Track control arm/Querlenker		
2	5011503 Højre/Right/Rechs 11/78 - Bærearmlenke/Track control arm/Querlenker	1	2
3	5011504 U Venstre/Left/Links - 10/78 Bærearmlenke/Track control arm/Querlenker		
4	5011505 U Højre/Right/Rechs - 10/78 Bærearmlenke/Track control arm/Querlenker	3	4
5	5031504 V/H - L/R Styrekugle/Tie rod end/Kugelgelenk	14x1,5 RHT Yderste/Outer/Außen	
6	5091501 (****) Manchetsæt/Boot kit/Manschetten satz		
7	5091502 (***) Manchetsæt/Boot kit/Manschetten satz	5	6
8	5111501 U V/H - L/R 160 mm. Stabilisator bolt/Stabilizer bolt/Stabilisator bolzen		8
		(*)	Uden Servo Styling Without Power Steering Ohne Servolenkung
		(***)	Uden styretøjsdæmper Without steering damper Ohne Lenkungs dämpfer
		(****)	Med styretøjsdæmper With steering damper Mit Lenkungs dämpfer
POS	316 - M3 (E30) (-IX) 9/82-8/91 & 318 i - M3 Cabrio (E30) (-IX) 12/85-10/93		
Foraksel/Front axle/Vorneachse			
1	5001503 Venstre/Left/Links Styrestang/Steering rod/Spurstange	Konus/Cone 14 mm.(****)	
2	5001503 V/H - L/R Styrestang/Steering rod/Spurstange	Konus/Cone 14 mm.(**) & (****)	
3	5001504 Højre/Right/Rechs Styrestang/Steering rod/Spurstange	Konus/Cone 14 mm. (****)	3+4
4	5001504 V/H - L/R Styrestang/Steering rod/Spurstange	Konus/Cone 14 mm.(*)	
5	5011522 Venstre/Left/Links Bærearmlenke/Track control arm/Querlenker		
6	5011523 Højre/Right/Rechs Bærearmlenke/Track control arm/Querlenker		
7	5031505 V/H - L/R Styrekugle/Tie rod end/Kugelgelenk	14x1,5 RHT Yderste/Outer/Außen	
8	5041502 V/H - L/R Bærekugle/Ball joint/Radgelenk	Inderste/Inner/Innen	
9	5041503 V/H - L/R Bærekugle/Ball joint/Radgelenk	Yderste/Outer/Außen	
10	5091503 (****) Manchetsæt/Boot kit/Manschetten satz	9	10

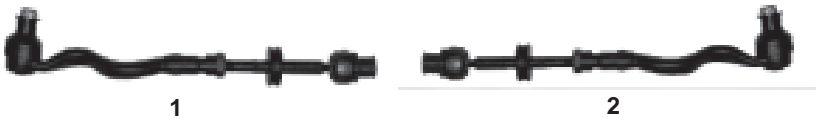

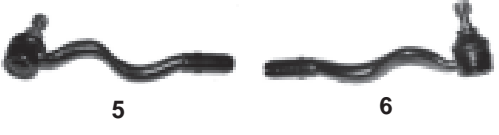



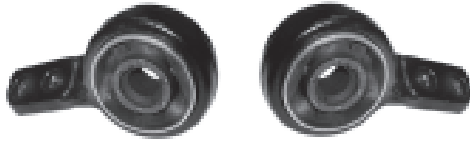









POS	316 - M3 (E30) (-IX)	9/82-8/91 & 318 i - M3 Cabrio (E30) (-IX)	12/85-10/93
11	5091504 Manchetsæt/Boot kit/Manschetten satz		
12	5101501 V/H - L/R 316-318iS (-AC) Bøsning/Bushing/Buchsen		
13	5101502 V/H - L/R 316-318iS (AC) Bøsning/Bushing/Buchsen		
14	5101502 V/H - L/R 320i/323i (Man) Bøsning/Bushing/Buchsen		
15	5101503 V/H - L/R 318iC/320iC/320iS/324D/TD/325E/i/iC Bøsning/Bushing/Buchsen		
16	5101503 V/H - L/R 320i/323i (Aut) Bøsning/Bushing/Buchsen		
17	5111503 V/H - L/R (-M3) Ø8 mm. 67 mm. Stabilisator/Stabilizer/Stabilisator		
18	5112503 V/H - L/R (M3) 240 mm. Stabilisatorstang/Stabilizer rod/Diagonalstrebe		
Bagaksel/Rear axle/Hinterachse			
19	5101505 V/H - L/R Bøsning/Bushing/Buchsen		
			(*) Uden Servo Styring Without Power Steering Ohne Servolenkung
			(**) Med Servo Styring With Power Steering Mit Servolenkung
			(****) Med styretøjsdæmper With steering damper Mit Lenkungs dämpfer
POS	316 - 325i Touring (E30) (-IX)	7/87-6/94	
Foraksel/Front axle/Vorneachse			
1	5001503 Venstre/Left/Links Styrestang/Steering rod/Spurstange	Konus/Cone 14 mm.(****)	
2	5001503 V/H - L/R Styrestang/Steering rod/Spurstange	Konus/Cone 14 mm.(**)	
3	5001504 Højre/Right/Rechs Styrestang/Steering rod/Spurstange	Konus/Cone 14 mm.(****)	
4	5001504 V/H - L/R Styrestang/Steering rod/Spurstange	Konus/Cone 14 mm.(*)	
5	5011522 Venstre/Left/Links Bærearmlenke/Track control arm/Querlenker		
6	5011523 Højre/Right/Rechs Bærearmlenke/Track control arm/Querlenker		
7	5031505 V/H - L/R Styrekugle/Tie rod end/Kugelgelenk	14x1,5 RHT Yderste/Outer/Außen	
8	5041502 Midt/Center/Mitte Bærekugle/Ball joint/Radgelenk		
9	5041503 V/H - L/R Bærekugle/Ball joint/Radgelenk	Yderste/Outer/Außen	



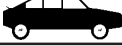

POS	316 - 325i Touring (E30) (-IX) 7/87-6/94		
10	5091501 (****) Manchetsæt/Boot kit/Manschetten satz		10
11	5091502 U (**) Manchetsæt/Boot kit/Manschetten satz		11
12	5101501 V/H - L/R 316-318iS (-AC) Bøsning/Bushing/Buchsen		12
13	5101502 V/H - L/R 316-318iS (AC) Bøsning/Bushing/Buchsen		13+14
14	5101502 V/H - L/R 320i/323i (Man) Bøsning/Bushing/Buchsen		15+16
15	5101503 V/H - L/R 318iC/320iC/320iS/324D/TD/325E/i/iC Bøsning/Bushing/Buchsen		17
16	5101503 V/H - L/R 320i/323i (Aut.) Bøsning/Bushing/Buchsen		
17	5111503 V/H - L/R Ø8 mm. 67 mm. Stabilisator/Stabilizer/Stabilisator		18
	Bagaksel/Rear axle/Hinterachse		
18	5101505 V/H - L/R Bøsning/Bushing/Buchsen		
		(*)	Uden Servo Styling Without Power Steering Ohne Servolenkung
		(**)	Med Servo Styling With Power Steering Mit Servolenkung
		(****)	Med styretøjsdæmper With steering damper Mit Lenkungs dämpfer
POS	325 iX (E30) 3/86-10/93		
	Foraksel/Front axle/Vorneachse		
1	5001503 Venstre/Left/Links Styrestang/Steering rod/Spurstange	Konus/Cone 14 mm.(****) 	1
2	5001504 Højre/Right/Rechts Styrestang/Steering rod/Spurstange	Konus/Cone 14 mm.(****) 	2
3	5031505 V/H - L/R Styrekugle/Tie rod end/Kugelgelenk	14x1,5 RHT Yderste/Outer/Außen	
4	5041512 U V/H - L/R Bærekugle/Ball joint/Radgelenk	Inderste/Inner/Innen	
5	5041513 V/H - L/R Bærekugle/Ball joint/Radgelenk	Yderste/Outer/Außen	
6	5091501 (****) Manchetsæt/Boot kit/Manschetten satz		6
7	5111503 V/H - L/R Stabilisator/Stabilizer/Stabilisator	Ø8 mm. 67 mm. 	7
		(****)	Med styretøjsdæmper With steering damper Mit Lenkungs dämpfer



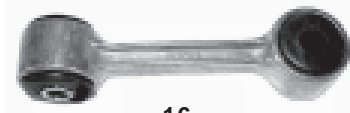
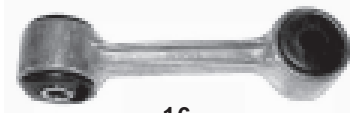

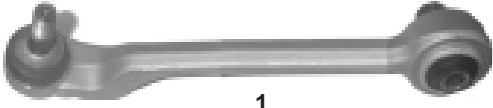

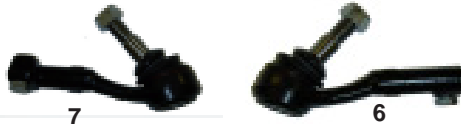
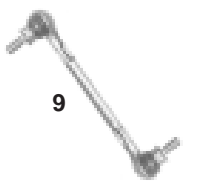
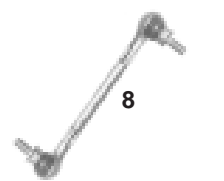
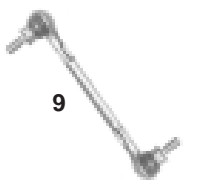
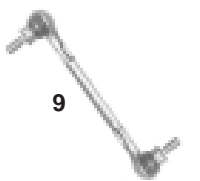
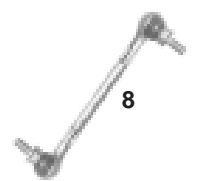
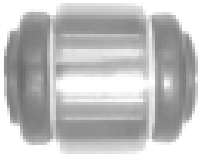





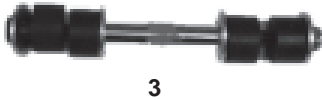

POS		316 i - M3 (E36)	9/90-2/98			
Foraksel/Front axle/Vorneachse						
1	5001508 Venstre/Left/Links Styrestang/Steering rod/Spurstange					
2	5001509 Højre/Right/Rechs (**) Styrestang/Steering rod/Spurstange					
3	5001514 Højre/Right/Rechs (*) & (***) Styrestang/Steering rod/Spurstange					
4	5011510 Venstre/Left/Links Bæream/Track control arm/Querlenker					
5	5011511 Højre/Right/Rechs Bæream/Track control arm/Querlenker					
6	5031511 Venstre/Left/Links 14x1,5 RHT Styrekugle/Tie rod end/Kugelgelenk					
7	5031512 Højre/Right/Rechs 14x1,5 RHT Styrekugle/Tie rod end/Kugelgelenk					
8	5031516 V/H - L/R 14x1,5 RHT Styrekugle/Tie rod end/Axialgelenk					
9	5041505 V/H - L/R Bærekugle/Ball joint/Radgelenk					
10	5041506 V/H - L/R Bærekugle/Ball joint/Radgelenk					
11	5091505 (**) Manchetsæt/Boot kit/Manschetten satz					
Bagaksel/Rear axle/Hinterachse						
12	5101501 V/H - L/R Bøsning/Bushing/Buchsen					
13	5101521 Venstre/Left/Links Bøsning/Bushing/Buchsen					
14	5101522 Højre/Right/Rechs Bøsning/Bushing/Buchsen					
15	5111503 V/H - L/R 11/91 - Stabilisator/Stabilizer/Stabilisator		Ø8 mm. 67 mm.			
16	5112503 V/H - L/R - 10/91 Stabilisatorstang/Stabilizer rod/Diagonalstrebe		240 mm.			
17	5101525 V/H - L/R Led/Joint/Gelenk					
18	5101526 For/Front/Vorne V/H - L/R Rep. sæt bagbro/Repair kit, Axle body/Reparatursatz, Achskörper					
19	5111509 V/H - L/R Ø8 mm. 100 mm. Stabilisator/Stabilizer/Stabilisator					
						(*) Uden Servo Styring Without Power Steering Ohne Servolenkung
						(**) Med Servo Styring With Power Steering Mit Servolenkung
						(****) Med styretøjsdæmper With steering damper Mit Lenkungs dämpfer

POS		316 i - 318 ti Compact (E36)	3/94-8/00 & 316 i - M3 Coupe (E36)	3/92-4/99
Foraksel/Front axle/Vorneachse				
1	5001508 Venstre/Left/Links Styrestang/Steering rod/Spurstange			
2	5001509 Højre/Right/Rechs Styrestang/Steering rod/Spurstange			
3	5011510 Venstre/Left/Links Bærearmlenke/Track control arm/Querlenker			
4	5011511 Højre/Right/Rechs Bærearmlenke/Track control arm/Querlenker			
5	5031511 Venstre/Left/Links Styrekugle/Tie rod end/Kugelgelenk	14x1,5 RHT Yderste/Outer/Außen		
6	5031512 Højre/Right/Rechs Styrekugle/Tie rod end/Kugelgelenk	14x1,5 RHT Yderste/Outer/Außen		
7	5031516 V/H - L/R Styrekugle/Tie rod end/Axialgelenk	14x1,5 RHT Inderste/Inner		
8	5041505 V/H - L/R Bærekugle/Ball joint/Radgelenk	Inderste/Inner/Innen		
9	5041506 V/H - L/R Bærekugle/Ball joint/Radgelenk	Yderste/Outer/Außen		
10	5091505 (**) Manchetsæt/Boot kit/Manschetten satz			
11	5101501 V/H - L/R Bøsning/Bushing/Buchsen			
POS				
12	5101521 Venstre/Left/Links Bøsning/Bushing/Buchsen			
13	5101522 Højre/Right/Rechs Bøsning/Bushing/Buchsen			
14	5111503 V/H - L/R Ø8 mm. 67 mm. Stabilisator/Stabilizer/Stabilisator			
Bagaksel/Rear axle/Hinterachse				
15	5101525 V/H - L/R Led/Joint/Gelenk			
16	5101526 For/Front/Vorne Rep. sæt bagbro/Repair kit, Axle body/Reparatursatz, Achskörper			
17	5111509 V/H - L/R Ø8 mm. 100 mm. Stabilisator/Stabilizer/Stabilisator			



POS		318 i - 328 i Touring (E36) 1/95-10/99 & 320 i - M3 Cabrio (E36) 3/93-4/99
		Foraksel/Front axle/Vorneachse
1	5001508 Venstre/Left/Links Styrestang/Steering rod/Spurstange	
2	5001509 Højre/Right/Rechs Styrestang/Steering rod/Spurstange	
3	5011510 Venstre/Left/Links Bæream/Track control arm/Querlenker	
4	5011511 Højre/Right/Rechs Bæream/Track control arm/Querlenker	
5	5031511 Venstre/Left/Links Styrekugle/Tie rod end/Kugelgelenk	14x1,5 RHT Yderste/Outer/Außen
6	5031512 Højre/Right/Rechs Styrekugle/Tie rod end/Kugelgelenk	14x1,5 RHT Yderste/Outer/Außen
7	5031516 V/H - L/R Styrekugle/Tie rod end/Axialgelenk	14x1,5 RHT Inderste/Inner
8	5041505 V/H - L/R Bærekugle/Ball joint/Radgelenk	Inderste/Inner/Innen
9	5041506 V/H - L/R Bærekugle/Ball joint/Radgelenk	Yderste/Outer/Außen
10	5091505 (**) Manchetsæt/Boot kit/Manschetten satz	
11	5101501 V/H - L/R Bøsning/Bushing/Buchsen	
POS		
12	5101521 Venstre/Left/Links Bøsning/Bushing/Buchsen	
13	5101522 Højre/Right/Rechs Bøsning/Bushing/Buchsen	
14	5111503 V/H - L/R Ø8 mm. 67 mm. Stabilisator/Stabilizer/Stabilisator	
		Bagaksel/Rear axle/Hinterachse
15	5101525 V/H - L/R Led/Joint/Gelenk	
16	5101526 For/Front/Vorne Rep. sæt bagbro/Repair kit, Axle body/Reparatursatz, Achskörper	V/H - L/R
17	5111509 V/H - L/R Ø8 mm. 100 mm. Stabilisator/Stabilizer/Stabilisator	
		(**) Med Servo Styring With Power Steering Mit Servolenkung

POS		316 i - 328 i Cabriolet E46 4/00- & 316 i - 328 i Compact E46 6/01- & 316 i - 328 i Coupe E46 4/99- & 316 i - 328 i E46 3/98- & 316 i - 328 i Touring E46 10/99-
Foraksel/Front axle/Vorneachse		
1	5001521 Venstre/Left/Links (-X & M3) 9/98 - Styrestang/Steering rod/Spurstange	
2	5001522 Højre/Right/Rechs (-X & M3) 9/98 - Styrestang/Steering rod/Spurstange	
3	5011527 Venstre/Left/Links (Aluminium) (-X & M3) Bærearmlenke/Track control arm/Querlenker	
4	5011528 Højre/Right/Rechs (Aluminium) (-X & M3) Bærearmlenke/Track control arm/Querlenker	
5	5031517 Venstre/Left/Links 14x1,5 (-X & M3) Styrekugle/Tie rod end/Kugelgelenk Yderste/Outer/Außen	
6	5031518 Højre/Right/Rechs 14x1,5 (-X & M3) Styrekugle/Tie rod end/Kugelgelenk Yderste/Outer/Außen	
7	5031519 V/H - L/R 14x1,5 (-X & M3) 9/98 - Styrekugle/Tie rod end/Axialgelenk Inderste/Inner	
8	5091506 Manchetsæt/Boot kit/Manschettensatz	
9	5101513 V/H - L/R (-X & M3) Bøsningssæt/Bushing set/Buchsen satz	
10	5111510 V/H - L/R 270 mm. (-X) Stabilisator/Stabilizer/Stabilisator	
11	5111525 Venstre/Left/Links 308 mm. (IX, XD) Stabilisatorstang/Stabilizer rod/Diagonalstrebe	
POS		
12	5111526 Højre/Right/Rechs 308 mm. (IX, XD) Stabilisatorstang/Stabilizer rod/Diagonalstrebe	
Bagaksel/Rear axle/Hinterachse		
13	5101514 V/H - L/R (-X & M3) Ø18 mm. Bøsning/Bushing/Buchsen	
14	5101515 V/H - L/R (-X & M3) Ø15 mm. Bøsning/Bushing/Buchsen	
15	5101525 V/H - L/R Led/Joint/Gelenk	
16	5111511 V/H - L/R (-M3) Ø8 mm. 95 mm. Stabilisator/Stabilizer/Stabilisator	







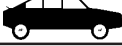
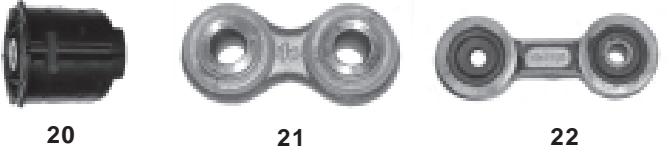











POS		318i - 330i (E90) 1/05- & 318i - 330i Touring (E91) 1/05-				
Foraksel/Front axle/Vorneachse						
1	5011539	Bag/Rear/Hinten	Venstre/Left/Links	Bærearmlenker/Track control arm/Querlenker	Nederste/Lower/Unten	
2	5011540	Bag/Rear/Hinten	Højre/Right/Rechts	Bærearmlenker/Track control arm/Querlenker	Nederste/Lower/Unten	
3	5011549	For/Front/Vorne	Venstre/Left/Links	Bærearmlenker/Track control arm/Querlenker	Nederste/Lower/Unten	
4	5011550	For/Front/Vorne	Højre/Right/Rechts	Bærearmlenker/Track control arm/Querlenker	Nederste/Lower/Unten	
5	5031520	V/H - L/R	14x1,5 RHT TRW	Styrekugle/Tie rod end/Axialgelenk	Inderste/Inner	
6	5031527	Venstre/Left/Links	14x1,5 RHT TRW	Styrekugle/Tie rod end/Kugulgelenk	Yderste/Outer/Außen	
7	5031528	Højre/Right/Rechts	14x1,5 RHT TRW	Styrekugle/Tie rod end/Kugulgelenk	Yderste/Outer/Außen	
8	5111517	Venstre/Left/Links	293 mm.	Stabilisatorstang/Stabilizer rod/Diagonalstrebe		
9	5111518	Højre/Right/Rechts	293 mm.	Stabilisatorstang/Stabilizer rod/Diagonalstrebe		
Bagaksel/Rear axle/Hinterachse						
10	5101524	V/H - L/R		Led/Joint/Gelenk		
11	5111516	V/H - L/R	163 mm.	Stabilisatorstang/Stabilizer rod/Diagonalstrebe		

POS	518 - 528i E12 8/72-5/81		
Foraksel/Front axle/Vorneachse			
1	5001505 U Midt/Center/Mitte Styrestang/Steering rod/Spurstange		
2	5011506 U Venstre/Left/Links Bæream/Track control arm/Querlenker		
3	5111501 V/H - L/R 160 mm. Stabilisator bolt/Stabilizer bolt/Stabilisator bolzen		
POS 518 - 535i E28 6/81-12/87			
Foraksel/Front axle/Vorneachse			
1	5001506 Midt/Center/Mitte Styrestang/Steering rod/Spurstange		
2	5001516 V/H - L/R Styrestang/Steering rod/Spurstange		
3	5011508 Venstre/Left/Links Bæream/Track control arm/Querlenker	Stål/Steel/Stahl Nederste/Lower/Unten	
4	5011509 Højre/Right/Rechs Bæream/Track control arm/Querlenker	Stål/Steel/Stahl Nederste/Lower/Unten	
5	5011520 Venstre/Left/Links Bæream/Track control arm/Querlenker	Øverste/Upper/Oben	
6	5011521 Højre/Right/Rechs Bæream/Track control arm/Querlenker	Øverste/Upper/Oben	
7	5031508 V/H - L/R Styrekugle/Tie rod end/Kugelgelenk	14x1,5 RHT Yderste/Outer/Außen	
8	5031509 V/H - L/R Styrekugle/Tie rod end/Axialgelenk	14x1,5 LHT Inderste/Inner	
9	5101504 V/H - L/R (518, 518i, 520-525e) - 5/85 Bøsning/Bushing/Buchsen Øverste/Upper/Oben	Indvendig/Inner/Innen 14 mm. Udvendig/Outer/Außen 58,5 mm.	
10	5101506 V/H - L/R Bøsning/Bushing/Buchsen Nederste/Lower/Unten	Indvendig/Inner/Innen 12 mm. Udvendig/Outer/Außen 46,5 mm.	







POS	518 - 535i E28 6/81-12/87		
		Foraksel/Front axle/Vorneachse	
11	5112503 V/H - L/R 240 mm. Stabilisatorstang/Stabilizer rod/Diagonalstrebe		11
		Bagaksel/Rear axle/Hinterachse	
12	5101507 V/H - L/R Bøsning/Bushing/Buchsen		12
13	5111505 V/H - L/R 50 mm. Stabilisator/Stabilizer/Stabilisator		13
14	5111509 V/H - L/R Ø8 mm. 100 mm. Stabilisator/Stabilizer/Stabilisator		14
POS	518 - M5 E34 1/88-10/95 & 518 - M5 Touring E34 11/91-1/97		
		Foraksel/Front axle/Vorneachse	
1	5001513 Midt/Center/Mitte (-518 i) Styrestang/Steering rod/Spurstange		1
2	5001515 Midt/Center/Mitte (518 i) Styrestang/Steering rod/Spurstange		2
3	5001516 V/H - L/R Styrestang/Steering rod/Spurstange		3
4	5011508 Venstre/Left/Links Bærearmlenke/Track control arm/Querlenker	(Stål/Steel/Stahl) Nederste/Lower/Unten	
5	5011509 Højre/Right/Rechts Bærearmlenke/Track control arm/Querlenker	(Stål/Steel/Stahl) Nederste/Lower/Unten	
6	5011512 Venstre/Left/Links Bærearmlenke/Track control arm/Querlenker	(Aluminium) Nederste/Lower/Unten	
7	5011513 Højre/Right/Rechts Bærearmlenke/Track control arm/Querlenker	(Aluminium) Nederste/Lower/Unten	
8	5011514 Bag/Rear/Hinten Bærearmlenke/Track control arm/Querlenker	Venstre/Left/Links Øverste/Upper/Oben	
9	5011515 Bag/Rear/Hinten Bærearmlenke/Track control arm/Querlenker	Højre/Right/Rechts Øverste/Upper/Oben	
10	5031508 V/H - L/R Styrekugle/Tie rod end/Kugelgelenk	14x1,5 RHT Yderste/Outer/Außen	











POS		518 - M5 E34 1/88-10/95 & 518 - M5 Touring E34 11/91-1/97
Foraksel/Front axle/Vorneachse		
11	5031509 V/H - L/R Styrekugle/Tie rod end/Axialgelenk	14x1,5 LHT Inderste/Inner
12	5031511 Venstre/Left/Links Styrekugle/Tie rod end/Kugelgelenk	14x1,5 RHT (ix) Yderste/Outer/Außen
13	5031512 Højre/Right/Rechs Styrekugle/Tie rod end/Kugelgelenk	14x1,5 RHT (ix) Yderste/Outer/Außen
14	5091505 Manchetsæt/Boot kit/Manschetten satz	
15	5101506 V/H - L/R Bøsning/Bushing/Buchsen	Indvendig/Inner/Innen 12 mm. Udvendig/Outer/Außen 46,52 mm.
16	5101509 V/H - L/R 518 M40/M43 Bøsning/Bushing/Buchsen	Indvendig/Inner/Innen 14 mm. Udvendig/Outer/Außen 58 mm.
17	5101510 V/H - L/R 520-540 M20/M50 Bøsning/Bushing/Buchsen	Indvendig/Inner/Innen 14 mm. Udvendig/Outer/Außen 58 mm.
18	5101511 V/H - L/R M5 B36/B38 Bøsning/Bushing/Buchsen	Indvendig/Inner/Innen 14 mm. Udvendig/Outer/Außen 58 mm.
19	5112503 V/H - L/R 240 mm. Stabilisatorstang/Stabilizer rod/Diagonalstrebe	
		
POS		
Bagaksel/Rear axle/Hinterachse		
20	5101508 V/H - L/R Bøsning/Bushing/Buchsen	
21	5111505 V/H - L/R 50 mm. Stabilisator/Stabilizer/Stabilisator	
22	5111512 V/H - L/R Ø8 mm. 60 mm. Stabilisator/Stabilizer/Stabilisator	
		







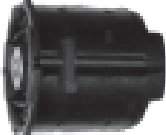







POS	520i - 530i E39 11/95- & 520i - 530i Touring E39 1/97-			
		Foraksel/Front axle/Vorneachse		
1	5001517 Venstre/Left/Links Styrestang/Steering rod/Spurstange			
2	5001518 Højre/Right/Rechs Styrestang/Steering rod/Spurstange		1	2
3	5011516 Venstre/Left/Links Bærearmlenke/Track control arm/Querlenker	(Aluminium) Nederste/Lower/Unten		
4	5011517 Højre/Right/Rechs Bærearmlenke/Track control arm/Querlenker	(Aluminium) Nederste/Lower/Unten	3	4
5	5011529 Venstre/Left/Links Bærearmlenke/Track control arm/Querlenker	(Aluminium) Øverste/Upper/Oben		
6	5011530 Højre/Right/Rechs Bærearmlenke/Track control arm/Querlenker	(Aluminium) Øverste/Upper/Oben	5	6
7	5031513 Venstre/Left/Links Styrekugle/Tie rod end/Kugelgelenk	16x1,0 RHT Konus/Cone 16 mm. Yderste/Outer/Außen		
8	5031514 Højre/Right/Rechs Styrekugle/Tie rod end/Kugelgelenk	16x1,0 RHT Konus/Cone 16 mm. Yderste/Outer/Außen	7	8
9	5031515 V/H - L/R Styrekugle/Tie rod end/Axialgelenk	18x1,5 RHT Inderste/Inner		
10	5091507 Manchetsæt/Boot kit/Manschetten satz		9	10
11	5101516 V/H - L/R Bøsning/Bushing/Buchsen	Nederste/Lower/Unten		11
POS				
12	5101517 V/H - L/R Bøsning/Bushing/Buchsen	Øverste/Upper/Oben		
13	5111506 Venstre/Left/Links 240 mm. Stabilisatorstang/Stabilizer rod/Diagonalstrebe		12	13
14	5111507 Højre/Right/Rechs 240 mm. Stabilisatorstang/Stabilizer rod/Diagonalstrebe			14
		Bagaksel/Rear axle/Hinterachse		
15	5011518 Venstre/Left/Links Bærearmlenke/Track control arm/Querlenker			
16	5011519 Højre/Right/Rechs Bærearmlenke/Track control arm/Querlenker		15	16
17	5101518 V/H - L/R Bøsning/Bushing/Buchsen			
18	5101523 V/H - L/R Led/Joint/Gelenk	Yderste/Outer/Außen	17	18
19	5111508 V/H - L/R Stabilisator/Stabilizer/Stabilisator	Yderste/Outer/Außen		19
20	5111513 V/H - L/R Stabilisator arm/Stabilizer lever/Stabilisator hebel	(Aluminium)		20

POS		535i/540i/M5 E39 4/96- & 540 Touring E39 1/97-		
Foraksel/Front axle/Vorneachse				
1	5001519 V/H - L/R Styrestang/Steering rod/Spurstange			 1
2	5011525 Venstre/Left/Links Bærearmlenke/Track control arm/Querlenker	Øverste/Upper/Oben		 2
3	5011526 Højre/Right/Rechts Bærearmlenke/Track control arm/Querlenker	Øverste/Upper/Oben		 3
4	5011531 Venstre/Left/Links Bærearmlenke/Track control arm/Querlenker	(Aluminium) Nederste/Lower/Unten		 4
5	5011532 Højre/Right/Rechts Bærearmlenke/Track control arm/Querlenker	(Aluminium) Nederste/Lower/Unten		 5
6	5031521 Venstre/Left/Links Styrekugle/Tie rod end/Kugelgelenk	16x1,5 Yderste/Outer/Außen		 6
7	5031522 Højre/Right/Rechts Styrekugle/Tie rod end/Kugelgelenk	16x1,5 Yderste/Outer/Außen		 7
8	5091507 Manchetsæt/Boot kit/Manschetten satz			 8
9	5101512 V/H - L/R Bøsning/Bushing/Buchsen	Øverste/Upper/Oben		 9
10	5101516 V/H - L/R Bøsning/Bushing/Buchsen	Nederste/Lower/Unten		 10
11	5111514 V/H - L/R 287 mm. Stabilisatorstang/Stabilizer rod/Diagonalstrebe			 11
Bagaksel/Rear axle/Hinterachse				
12	5011518 Venstre/Left/Links Bærearmlenke/Track control arm/Querlenker	Nederste/Lower/Unten		 12
13	5011519 Højre/Right/Rechts Bærearmlenke/Track control arm/Querlenker	Nederste/Lower/Unten		 13
14	5101518 V/H - L/R Bøsning/Bushing/Buchsen			 14
15	5101523 V/H - L/R Led/Joint/Gelenk			 15
16	5111508 V/H - L/R Stabilisator/Stabilizer/Stabilisator	Yderste/Outer/Außen		 16
17	5111513 V/H - L/R (Aluminium) Stabilisator arm/Stabilizer lever/Stabilisator hebel			 17

POS	5 Serie (E60)/5 Touring (E61) 7/03-
Foraksel/Front axle/Vorneachse	
1	5011551 For/Front/Vorne Bæream/Track control arm/Querlenker Venstre/Left/Links Nederste/Lower/Unten
2	5011552 For/Front/Vorne Bæream/Track control arm/Querlenker Højre/Right/Rechs Nederste/Lower/Unten
3	5011553 Bag/Rear/Hinten Bæream/Track control arm/Querlenker Venstre/Left/Links (E60) Nederste/Lower/Unten
4	5011554 Bag/Rear/Hinten Bæream/Track control arm/Querlenker Højre/Right/Rechs (E60) Nederste/Lower/Unten
5	5031526 V/H - L/R Styrekugle/Tie rod end/Kugelgelenk 16x1,5 RHT Yderste/Outer/Außen
6	5031531 V/H - L/R 293 mm. Styrekugle/Tie rod end/Axialgelenk 16x1,5 RHT Inderste/Inner
7	5111527 Venstre/Left/Links 300 mm. Stabilisatorstang/Stabilizer rod/Diagonalstrebe
8	5111528 Højre/Right/Rechs 300 mm. Stabilisatorstang/Stabilizer rod/Diagonalstrebe
Bagaksel/Rear axle/Hinterachse	
9	5111529 V/H - L/R 133 mm. Stabilisator/Stabilizer/Stabilisator
POS	628 CSi - M635 CSi E24 1982-9/90
Foraksel/Front axle/Vorneachse	
1	5001506 Midt/Center/Mitte Styrestang/Steering rod/Spurstange
2	5001516 V/H - L/R Styrestang/Steering rod/Spurstange
3	5011508 Venstre/Left/Links Bæream/Track control arm/Querlenker (Stål/Steel/Stahl) Nederste/Lower/Unten
4	5011509 Højre/Right/Rechs Bæream/Track control arm/Querlenker (Stål/Steel/Stahl) Nederste/Lower/Unten
5	5011520 Venstre/Left/Links Bæream/Track control arm/Querlenker Øverste/Upper/Oben
6	5011521 Højre/Right/Rechs Bæream/Track control arm/Querlenker Øverste/Upper/Oben
7	5031508 V/H - L/R Styrekugle/Tie rod end/Kugelgelenk 14x1,5 RHT Yderste/Outer/Außen
8	5031509 V/H - L/R Styrekugle/Tie rod end/Axialgelenk 14x1,5 LHT Inderste/Inner
9	5101504 V/H - L/R Bøsning/Bushing/Buchsen Øverste/Upper/Oben Indvendig/Inner/Innen 14mm. Udvendig/Outer/Außen 58,5 mm.
10	5101506 V/H - L/R Bøsning/Bushing/Buchsen Nederste/Lower/Unten Indvendig/Inner/Innen 12 mm. Udvendig/Outer/Außen 46,5 mm.
11	5112503 V/H - L/R 240 mm. Stabilisatorstang/Stabilizer rod/Diagonalstrebe

POS	 628 CSi - M635 CSi E24 1982-9/90		
		Bagaksel/Rear axle/Hinterachse	
12	5101507 V/H - L/R Bøsning/Bushing/Buchsen		
13	5111505 V/H - L/R 50 mm. Stabilisator/Stabilizer/Stabilisator		
14	5111509 V/H - L/R Ø8 mm. 100 mm. Stabilisator/Stabilizer/Stabilisator		
POS	 6 Serie (E63)/6 Serie Cabriolet (E64) 1/04-		
		Foraksel/Front axle/Vorneachse	
1	5031526 V/H - L/R Styrekugle/Tie rod end/Kugelgelenk	16x1,5 RHT Yderste/Outer/Außen	
2	5031531 V/H - L/R 293 mm. Styrekugle/Tie rod end/Axialgelenk	16x1,5 RHT Inderste/Inner	
		Bagaksel/Rear axle/Hinterachse	
3	5111529 V/H - L/R 133 mm. Stabilisator/Stabilizer/Stabilisator		



POS	7 Serie E23 76-90		
		Bagaksel/Rear axle/Hinterachse	
1	5101507 V/H - L/R Bøsning/Bushing/Buchsen		 1
POS	730 - 750i E32 9/86-9/94		
		Foraksel/Front axle/Vorneachse	
1	5001516 V/H - L/R Styrestang/Steering rod/Spurstange		 1
2	5011508 Venstre/Left/Links Bærearml/Track control arm/Querlenker	(Stål/Steel/Stahl) Nederste/Lower/Unten	 2
3	5011509 Højre/Right/Rechs Bærearml/Track control arm/Querlenker	(Stål/Steel/Stahl) Nederste/Lower/Unten	 3
4	5031508 V/H - L/R Styrekugle/Tie rod end/Kugelgelenk	14x1,5 RHT Yderste/Outer/Außen	 4
5	5031509 V/H - L/R Styrekugle/Tie rod end/Axialgelenk	14x1,5 LHT Inderste/Inner	 5
6	5101506 V/H - L/R Bøsning/Bushing/Buchsen	Nederste/Lower/Unten	 6
7	5112503 V/H - L/R 240 mm. Stabilisatorstang/Stabilizer rod/Diagonalstrebe		 7
		Bagaksel/Rear axle/Hinterachse	
8	5101508 V/H - L/R Bøsning/Bushing/Buchsen		 8
9	5111505 V/H - L/R 50 mm. Stabilisator/Stabilizer/Stabilisator		 9

POS	730i, 740i, 750i E38 10/94-11/01		
Foraksel/Front axle/Vorneachse			
1	5001520 Styrestang/Steering rod/Spurstange		 1
2	5011533 Venstre/Left/Links Bærearmlenke/Track control arm/Querlenker Nederste/Lower/Unten		 2
3	5011534 Højre/Right/Rechs Bærearmlenke/Track control arm/Querlenker Nederste/Lower/Unten		 3
4	5011535 Venstre/Left/Links Bærearmlenke/Track control arm/Querlenker Øverste/Upper/Oben		 4
5	5011536 Højre/Right/Rechs Bærearmlenke/Track control arm/Querlenker Øverste/Upper/Oben		 5
6	5031523 Venstre/Left/Links 16x1,5 Styrekugle/Tie rod end/Kugelgelenk Yderste/Outer/Außen		 6
7	5031524 Højre/Right/Rechs 16x1,5 Styrekugle/Tie rod end/Kugelgelenk Yderste/Outer/Außen		 7
8	5101512 V/H - L/R Bøsning/Bushing/Buchsen Øverste/Upper/Oben		 8
9	5101519 V/H - L/R Bøsning/Bushing/Buchsen Nederste/Lower/Unten		 9
10	5111515 V/H - L/R 308 mm. Stabilisatorstang/Stabilizer rod/Diagonalstrebe		 10
Bagaksel/Rear axle/Hinterachse			
11	5011537 Venstre/Left/Links Bærearmlenke/Track control arm/Querlenker Nederste/Lower/Unten		 11
12	5011538 Højre/Right/Rechs Bærearmlenke/Track control arm/Querlenker Nederste/Lower/Unten		 12
13	5101520 V/H - L/R Bøsning/Bushing/Buchsen Øverste/Upper/Oben		 13
14	5111502 V/H - L/R 76 mm. Stabilisatorstang/Stabilizer rod/Diagonalstrebe		 14
15	5111513 V/H - L/R (Aluminium) Stabilisator arm/Stabilizer lever/Stabilisator hebel Øverste/Upper/Oben		 15

POS	730i, 735i, 740i, 745i, 760i E65	11/01-		
Foraksel/Front axle/Vorneachse				
1	5031525 V/H - L/R Styrekugle/Tie rod end/Axialgelenk	Inderste/Inner		1
2	5031526 V/H - L/R Styrekugle/Tie rod end/Kugelgelenk	16x1,5 RHT Yderste/Outer/Außen		2
POS 840 Ci - 850 i/Ci/CSi E31 9/90-12/99				
Foraksel/Front axle/Vorneachse				
1	5001516 V/H - L/R Styrestang/Steering rod/Spurstange			1
2	5031508 V/H - L/R Styrekugle/Tie rod end/Kugelgelenk	14x1,5 RHT Yderste/Outer/Außen		2
3	5031509 V/H - L/R Styrekugle/Tie rod end/Axialgelenk	14x1,5 LHT Inderste/Inner		3
4	5112503 V/H - L/R 240 mm. Stabilisatorstang/Stabilizer rod/Diagonalstrebe			4
POS X3 (E83) 1/04-				
Foraksel/Front axle/Vorneachse				
1	5011541 Bag/Rear/Hinten Bærearmlenke/Track control arm/Querlenker	Venstre/Left/Links Nederste/Lower/Unten		1
2	5011542 Bag/Rear/Hinten Bærearmlenke/Track control arm/Querlenker	Højre/Right/Rechs Nederste/Lower/Unten		2
3	5011555 For/Front/Vorne Bærearmlenke/Track control arm/Querlenker	Venstre/Left/Links Nederste/Lower/Unten		
4	5011556 For/Front/Vorne Bærearmlenke/Track control arm/Querlenker	Højre/Right/Rechs Nederste/Lower/Unten		5
5	5031529 V/H - L/R Styrekugle/Tie rod end/Kugelgelenk	Yderste/Outer/Außen		
6	5031530 V/H - L/R - 1/05 Styrekugle/Tie rod end/Axialgelenk	Inderste/Inner		6
7	5041514 V/H - L/R Bærekugle/Ball joint/Radgelenk	Nederste/Lower/Unten		
8	5111519 Venstre/Left/Links 298 mm. Stabilisatorstang/Stabilizer rod/Diagonalstrebe			
9	5111520 Højre/Right/Rechs 298 mm. Stabilisatorstang/Stabilizer rod/Diagonalstrebe			10
Bagaksel/Rear axle/Hinterachse				
10	5111521 V/H - L/R 95 mm. Stabilisator/Stabilizer/Stabilisator			

BMW

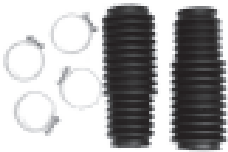
POS	X5 (E53) 5/00-			
Foraksel/Front axle/Vorneachse				
1	5011543 Bag/Rear/Hinten Bærearmlenker/Track control arm/Querlenker	Venstre/Left/Links Nederste/Lower/Unten		
2	5011544 Bag/Rear/Hinten Bærearmlenker/Track control arm/Querlenker	Højre/Right/Rechs Nederste/Lower/Unten		
3	5011547 For/Front/Vorne Bærearmlenker/Track control arm/Querlenker	Venstre/Left/Links Nederste/Lower/Unten		
4	5011548 For/Front/Vorne Bærearmlenker/Track control arm/Querlenker	Højre/Right/Rechs Nederste/Lower/Unten		
5	5041515 V/H - L/R Bærekugle/Ball joint/Radgelenk	Nederste/Lower/Unten		
6	5111523 Venstre/Left/Links 359 mm. Stabilisatorstang/Stabilizer rod/Diagonalstrebe			
7	5111524 Højre/Right/Rechs 359 mm. Stabilisatorstang/Stabilizer rod/Diagonalstrebe			
Bagaksel/Rear axle/Hinterachse				
8	5011524 V/H - L/R Bærearmlenker/Track control arm/Querlenker	Øverste/Upper/Oben		
9	5011545 Venstre/Left/Links Bærearmlenker/Track control arm/Querlenker			
10	5011546 Højre/Right/Rechs Bærearmlenker/Track control arm/Querlenker			
11	5111522 V/H - L/R Stabilisator/Stabilizer/Stabilisator			

POS	Z1 1988-91
Foraksel/Front axle/Vorneachse	
1	<p>5031505 V/H - L/R 14x1,5 RHT Styrekugle/Tie rod end/Kugelgelenk Yderste/Outer/Außen</p>  <p style="text-align: center;">1</p>
2	<p>5091504 Manchetsæt/Boot kit/Manschetten satz</p>  <p style="text-align: center;">2</p>
3	<p>5111503 V/H - L/R Ø8 mm. 67 mm. Stabilisator/Stabilizer/Stabilisator</p>  <p style="text-align: center;">3</p>
POS	



POS	Z3 10/95-		
		Foraksel/Front axle/Vorneachse	
1	5001508 Venstre/Left/Links Styrestang/Steering rod/Spurstange		
2	5001509 Højre/Right/Rechs Styrestang/Steering rod/Spurstange		
3	5011510 Venstre/Left/Links Bærearmlenke/Track control arm/Querlenker	(-M3) Nederste/Lower/Unten	
4	5011511 Højre/Right/Rechs Bærearmlenke/Track control arm/Querlenker	(-M3) Nederste/Lower/Unten	
5	5031511 Venstre/Left/Links Styrekugle/Tie rod end/Kugelgelenk	14x1,5 RHT Yderste/Outer/Außen	
6	5031512 Højre/Right/Rechs Styrekugle/Tie rod end/Kugelgelenk	14x1,5 RHT Yderste/Outer/Außen	
7	5031516 V/H - L/R Styrekugle/Tie rod end/Axialgelenk	14x1,5 RHT Inderste/Inner	
8	5041505 V/H - L/R Bærekugle/Ball joint/Radgelenk	Inderste/Inner	
9	5041506 V/H - L/R Bærekugle/Ball joint/Radgelenk	Yderste/Outer/Außen	
10	5091505 Manchetsæt/Boot kit/Manschetten satz		
11	5101501 V/H - L/R Bøsning/Bushing/Buchsen	Nederste/Lower/Unten	
POS			
12	5111503 V/H - L/R Ø8 mm. 67 mm. (-M3) Stabilisator/Stabilizer/Stabilisator		
	Bagaksel/Rear axle/Hinterachse		
13	5101525 V/H - L/R Led/Joint/Gelenk		
14	5111512 V/H - L/R Ø8 mm. 60 mm. Stabilisator/Stabilizer/Stabilisator		

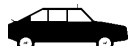

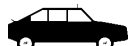
BMW

POS	
POS	

POS	
POS	

CHRYSLER

POS	
POS	



POS	2 CV 1959- & Acadiane 1981-88 & Ami 6/8 1965-79 & Dyane 4/6 1967-83 & Mehari 1969-
	<p>Foraksel/Front axle/Vorneachse</p> <p>1 5071901 U Styreboltsæt/Steering pin set/Lenkzapfen satz</p> <p>For & bagaksel/Front & Rear axle/Vorne & Hinterachse</p> <p>2 5101902 U Bøsningsæt/Bushing set/Buchsen satz</p> 
POS	AX 6/86-12/98
	<p>Foraksel/Front axle/Vorneachse</p> <p>1 5011901 Venstre/Left/Links (-GTI) - 7/91 Bærearmlenke/Track control arm/Querlenker Nederste/Lower/Unten</p> <p>2 5011902 Højre/Right/Rechs (-GTI) - 7/91 Bærearmlenke/Track control arm/Querlenker Nederste/Lower/Unten</p> <p>3 5013705 Venstre/Left/Links Stål/Steel/Stahl (-GTI) 8/91 - Bærearmlenke/Track control arm/Querlenker Nederste/Lower/Unten</p> <p>4 5013706 Højre/Right/Rechs Stål/Steel/Stahl (-GTI) 8/91 - Bærearmlenke/Track control arm/Querlenker Nederste/Lower/Unten</p> <p>5 5021906 U Tandstang/Steering rack/Zahnstange</p> <p>6 5033717 Venstre/Left/Links 14x1,5 RHT Styreknude/Tie rod end/Kugelgelenk Yderste/Outer/Außen</p> <p>7 5033718 Højre/Right/Rechs 14x1,5 RHT Styreknude/Tie rod end/Kugelgelenk Yderste/Outer/Außen</p> <p>8 5041909 V/H - L/R Ø14mm. Bærekugle/Ball joint/Radgelenk - 7/91 Nederste/Lower/Unten</p> <p>9 5043706 V/H - L/R Ø16mm. Bærekugle/Ball joint/Radgelenk 8/91 - Nederste/Lower/Unten</p> <p>10 5091906 Manchetsæt/Boot kit/Manschetten satz</p> 

POS	AX 6/86-12/98				
Foraksel/Front axle/Vorneachse					
11	5101910 For/Front/Vorne Bøsning/Bushing/Buchsen	V/H - L/R	(-GTI)		
12	5101911 Bag/Rear/Hinten Bøsning/Bushing/Buchsen	V/H - L/R	(-GTI) 8/91 -		
13	5101914 Bag/Rear/Hinten Bøsning/Bushing/Buchsen	V/H - L/R	(-GTI) - 7/91	11	12
14	5113701 V/H - L/R 345 mm. Stabilisatorstang/Stabilizer rod/Diagonalstrebe				
				13	14
POS	Berlingo 10/96-				
Foraksel/Front axle/Vorneachse					
1	5011913 Venstre/Left/Links (-2.0 HDi) CH. - 7973 Bærearmlenker/Track control arm/Querlenker		Konus/Cone 16mm. (**)		
2	5011914 Højre/Right/Rechs (-2.0 HDi) CH. - 7973 Bærearmlenker/Track control arm/Querlenker		Konus/Cone 16mm. (**)	1	2
3	5011915 Venstre/Left/Links (-2.0 HDi) CH. - 7973 Bærearmlenker/Track control arm/Querlenker		Konus/Cone 16mm. (*)		
4	5011916 Højre/Right/Rechs (-2.0 HDi) CH. - 7973 Bærearmlenker/Track control arm/Querlenker		Konus/Cone 16mm. (*)	3	4
5	5011933 Venstre/Left/Links (2.0 HDi) Bærearmlenker/Track control arm/Querlenker				
6	5011934 Højre/Right/Rechs (2.0 HDi) Bærearmlenker/Track control arm/Querlenker	5		7	8
7	5013737 Venstre/Left/Links (-2.0 HDi) CH. 7974- Bærearmlenker/Track control arm/Querlenker		Konus/Cone 18mm. (**)		
8	5013738 Højre/Right/Rechs (-2.0 HDi) CH. 7974- Bærearmlenker/Track control arm/Querlenker		Konus/Cone 18mm. (**)	9	10
9	5013739 Venstre/Left/Links (-2.0 HDi) CH. 7974- Bærearmlenker/Track control arm/Querlenker		Konus/Cone 18mm. (*)	(*)	Uden Servo Styling Without Power Steering Ohne Servolenkung
10	5013740 Højre/Right/Rechs (-2.0 HDi) CH. 7974- Bærearmlenker/Track control arm/Querlenker		Konus/Cone 18mm. (*)	(**)	Med Servo Styling With Power Steering Mit Servolenkung

POS	Berlingo 10/96-					
Foraksel/Front axle/Vorneachse						
11	5031914	V/H - L/R	14x1,5 RHT (-2.0 HDi)	Styrekugle/Tie rod end/Axialgelenk	Inderste/Inner	11
12	5031934	V/H - L/R	14x1,5 RHT (2.0 HDi)	Styrekugle/Tie rod end/Axialgelenk	Inderste/Inner	12
13	5033702	V/H - L/R	14x1,5 RHT	Styrekugle/Tie rod end/Kugelgelenk	Yderste/Outer/Außen	13
14	5041916	V/H - L/R	CH. - 7973 - 8/98	Konus/Cone 16mm. (*)	Nederste/Lower/Unten	14
15	5041917	V/H - L/R	CH. - 7973 - 8/98	Konus/Cone 16mm. (**)	Nederste/Lower/Unten	15
16	5041918	V/H - L/R	(-2.0 HDi) CH. 7974 - 9/98 -	Konus/Cone 18mm. (*)	Nederste/Lower/Unten	16
17	5041919	V/H - L/R	(-2.0 HDi) CH. 7974 - 9/98 -	Konus/Cone 18mm. (**)	Nederste/Lower/Unten	17
18	5093708	(**)		Manchetsæt/Boot kit/Manschetten satz		18
19	5101905	Bag/Rear/Hinten	V/H - L/R	Bøsning/Bushing/Buchsen		19
20	5101906	For/Front/Vorne	V/H - L/R	Bøsningssæt/Bushing set/Buchsen satz		20
21	5111901	V/H - L/R	301 mm.	Stabilisatorstang/Stabilizer rod/Diagonalstrebe		21
POS BX & BX Break 9/82-12/94						
Foraksel/Front axle/Vorneachse						
1	5011917 U	Venstre/Left/Links		Bærearmlenke/Track control arm/Querlenker		1
2	5011918 U	Højre/Right/Rechs		Bærearmlenke/Track control arm/Querlenker		2
3	5031905	Venstre/Left/Links	14x1,5 RHT	Styrekugle/Tie rod end/Kugelgelenk	Yderste/Outer/Außen	3
4	5031906	Højre/Right/Rechs	14x1,5 RHT	Styrekugle/Tie rod end/Kugelgelenk	Yderste/Outer/Außen	4
5	5031907	V/H - L/R	14x1,5 RHT	Styrekugle/Tie rod end/Axialgelenk	Inderste/Inner	5
6	5043705	Ø38mm. RHT		Bærekugle/Ball joint/Radgelenk	Nederste/Lower/Unten	6
7	5101901 U	V/H - L/R	- 9/85	Bøsningssæt/Bushing set/Buchsen satz		7
8	5111909	V/H - L/R		Stabilisatorstang/Stabilizer rod/Diagonalstrebe		8
Bagaksel/Rear axle/Hinterachse						
9	5101903	V/H - L/R		Bøsningssæt/Bushing set/Buchsen satz		9
					(*)	Uden Servo Styling Without Power Steering Ohne Servolenkung
					(**)	Med Servo Styling With Power Steering Mit Servolenkung

POS	C3 2/02-				
Foraksel/Front axle/Vorneachse					
1	5011929 Venstre/Left/Links Bærearmlenke/Track control arm/Querlenker	Nederste/Lower/Unten			
2	5011930 Højre/Right/Rechs Bærearmlenke/Track control arm/Querlenker	Nederste/Lower/Unten			
3	5031927 Venstre/Left/Links Styrekugle/Tie rod end/Kugelgelenk	14x1,5 RHT Yderste/Outer/Außen			
4	5031928 Højre/Right/Rechs Styrekugle/Tie rod end/Kugelgelenk	14x1,5 RHT Yderste/Outer/Außen			
5	5031929 V/H - L/R 14x1,5 RHT Styrekugle/Tie rod end/Axialgelenk	Inderste/Inner			
6	5041920 V/H - L/R Bærekugle/Ball joint/Radgelenk	Nederste/Lower/Unten			
7	5101916 For/Front/Vorne Bøsning/Bushing/Buchsen	V/H - L/R			
8	5101917 Bag/Rear/Hinten Bøsning/Bushing/Buchsen	V/H - L/R			
9	5113706 V/H - L/R 335 mm. Stabilisatorstang/Stabilizer rod/Diagonalstrebe				
POS C4 11/04-					
Foraksel/Front axle/Vorneachse					
1	5013725 Venstre/Left/Links Bærearmlenke/Track control arm/Querlenker	Nederste/Lower/Unten			
2	5013726 Højre/Right/Rechs Bærearmlenke/Track control arm/Querlenker	Nederste/Lower/Unten			
3	5033717 Højre/Right/Rechs Styrekugle/Tie rod end/Kugelgelenk	14x1,5 RHT Yderste/Outer/Außen			
4	5033718 Venstre/Left/Links Styrekugle/Tie rod end/Kugelgelenk	14x1,5 RHT Yderste/Outer/Außen			
5	5033725 V/H - L/R 14x1,5 RHT Styrekugle/Tie rod end/Axialgelenk	Org. - 10310 Inderste/Inner			
6	5033731 V/H - L/R 14x1,5 Styrekugle/Tie rod end/Axialgelenk	Org. 10311- Inderste/Inner			
7	5043712 V/H - L/R Bærekugle/Ball joint/Radgelenk	Nederste/Lower/Unten			
8	5103712 Bag/Rear/Hinten Bøsning/Bushing/Buchsen	V/H - L/R			
9	5103713 For/Front/Vorne Bøsning/Bushing/Buchsen	V/H - L/R			
10	5113710 V/H - L/R 335 mm. Stabilisator bolt/Stabilizer bolt/Stabilisator bolzen				















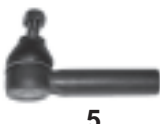

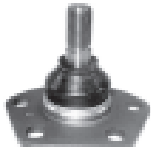

POS	C5 3/01- & C5 Break 6/01-		
Foraksel/Front axle/Vorneachse			
1	5011931 Venstre/Left/Links Bæream/Track control arm/Querlenker	Stål/Steel/Stahl Nederste/Lower/Unten	
2	5011932 Højre/Right/Rechs Bæream/Track control arm/Querlenker	Stål/Steel/Stahl Nederste/Lower/Unten	
3	5031931 Venstre/Left/Links Styrekugle/Tie rod end/Kugelgelenk	16x1,5 RHT Yderste/Outer/Außen	
4	5031932 Højre/Right/Rechs Styrekugle/Tie rod end/Kugelgelenk	16x1,5 RHT Yderste/Outer/Außen	
5	5031933 V/H - L/R Styrekugle/Tie rod end/Axialgelenk	16x1,5 RHT Inderste/Inner	
6	5041912 Bærekugle/Ball joint/Radgelenk	Ø40mm. RHT (Break) Nederste/Lower/Unten	
7	5041912 V/H - L/R Bærekugle/Ball joint/Radgelenk	Ø40mm. RHT (-Break) Nederste/Lower/Unten	
8	5101918 For/Front/Vorne Bøsning/Bushing/Buchsen	V/H - L/R	
9	5101919 Bag/Rear/Hinten Bøsning/Bushing/Buchsen	V/H - L/R	
10	5111903 V/H - L/R 320 mm. Stabilisatorstang/Stabilizer rod/Diagonalstrebe		
POS C6 9/05-			
Foraksel/Front axle/Vorneachse			
1	5113713 Venstre/Left/Links Stabilisatorstang/Stabilizer rod/Diagonalstrebe		
2	5113714 Højre/Right/Rechs Stabilisatorstang/Stabilizer rod/Diagonalstrebe		
Bagaksel/Rear axle/Hinterachse			
3	5113715 V/H - L/R Stabilisator bolt/Stabilizer bolt/Stabilisator bolzen		

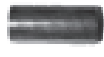
POS	 C8 7/02-
	<p>Foraksel/Front axle/Vorneachse</p> <div style="display: flex; justify-content: space-around; align-items: center;"> <div style="width: 45%;"> <p>1 5011939 Venstre/Left/Links Bæream/Track control arm/Querlenker</p> <p>2 5011940 Højre/Right/Rechs Bæream/Track control arm/Querlenker</p> <p>3 XXXXXXX V/H - L/R Styrekugle/Tie rod end/Axialgelenk Inderste/Inner</p> <p>4 XXXXXXX V/H - L/R 14x1,5 Konus/Cone 13,5mm. Styrekugle/Tie rod end/Kugelgelenk Yderste/Outer/Außen</p> <p>5 XXXXXXX V/H - L/R 262,5 mm. Stabilisatorstang/Stabilizer rod/Diagonalstrebe</p> </div> <div style="width: 45%; text-align: center;">  </div> </div>
POS	

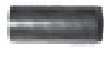
POS	C15 10/84-12/97			
		Foraksel/Front axle/Vorneachse		
1	5013701 Venstre/Left/Links Bærearml/Track control arm/Querlenker	Nederste/Lower/Unten		
2	5013702 Højre/Right/Rechs Bærearml/Track control arm/Querlenker	Nederste/Lower/Unten		
3	5023706 CH. - 4679 - 9/89 Tandstang/Steering rack/Zahnstange			
4	5033701 V/H - L/R 14x1,5 RHT Styrekugle/Tie rod end/Axialgelenk	Inderste/Inner		
5	5033702 V/H - L/R 14x1,5 RHT Styrekugle/Tie rod end/Kugelgelenk	Yderste/Outer/Außen		
6	5041901 V/H - L/R Bærekugle/Ball joint/Radgelenk	Nederste/Lower/Unten		
7	5093703 Manchetsæt/Boot kit/Manschetten satz			
8	5103702 For/Front/Vorne Bøsning/Bushing/Buchsen	V/H - L/R		
9	5103703 Bag/Rear/Hinten Bøsning/Bushing/Buchsen	V/H - L/R		
</				

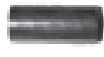

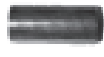

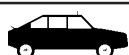
POS	CX 10/75-6/80			
		Bagaksel/Rear axle/Hinterachse		
1	5101904 U V/H - L/R (**) Bøsningssæt/Bushing set/Buchsen satz			
				1
POS	Evasion 6/94-7/02			
		Foraksel/Front axle/Vorneachse		
1	5011905 Venstre/Left/Links Bærearmlenke/Track control arm/Querlenker	Støbejern/Cast iron/Grauguß		
2	5011906 Højre/Right/Rechs Bærearmlenke/Track control arm/Querlenker	Støbejern/Cast iron/Grauguß		
				1 2
3	5031916 V/H - L/R 14x1,5 RHT Styrekugle/Tie rod end/Kugelgelenk	Konus/Cone 15mm. Yderste/Outer/Außen		
4	5031917 V/H - L/R M14x1,5 RHT Styrekugle/Tie rod end/Axialgelenk	Inderste/Inner		
				3 4
5	5093712 Manchetsæt/Boot kit/Manschetten satz			
				5 6
6	5101907 For/Front/Vorne Bøsning/Bushing/Buchsen	V/H - L/R		
7	5101908 Bag/Rear/Hinten Bøsning/Bushing/Buchsen	Venstre/Left/Links		
8	5101909 Bag/Rear/Hinten Bøsning/Bushing/Buchsen	Højre/Right/Rechs		
9	5112302 V/H - L/R Ø12mm. 120 mm. Stabilisator/Stabilizer/Stabilisator			
				7 8 9













POS	Jumper 230 2/94-4/02			
Foraksel/Front axle/Vorneachse				
1	5011909 Venstre/Left/Links Bærearmlenke/Track control arm/Querlenker	(1.0 - 1.4 T) - 1/01		
2	5011910 Højre/Right/Rechts Bærearmlenke/Track control arm/Querlenker	(1.0 - 1.4 T) - 1/01		
3	5011911 Venstre/Left/Links Bærearmlenke/Track control arm/Querlenker	(1.8 T) - 1/01		
4	5011912 Højre/Right/Rechts Bærearmlenke/Track control arm/Querlenker	(1.8 T) - 1/01		
5	5011935 Venstre/Left/Links Bærearmlenke/Track control arm/Querlenker	(1.0 - 1.4 T) 2/01 -		
6	5011936 Højre/Right/Rechts Bærearmlenke/Track control arm/Querlenker	(1.0 - 1.4 T) 2/01 -		
7	5011937 Venstre/Left/Links Bærearmlenke/Track control arm/Querlenker	(1.8 T) 2/01 -		
8	5011938 Højre/Right/Rechts Bærearmlenke/Track control arm/Querlenker	(1.8 T) 2/01 -		
9	5031918 V/H - L/R Styrekuhle/Tie rod end/Kugelgelenk	16x1,5 RHT Yderste/Outer/Außen		
10	5031919 V/H - L/R Styrekuhle/Tie rod end/Axialgelenk	16x1,5 RHT Inderste/Inner		
11	5041914 V/H - L/R Bærekugle/Ball joint/Radgelenk	(1.0 - 1.4 T) - 1/01 Nederste/Lower/Unten		
12	5041915 V/H - L/R Bærekugle/Ball joint/Radgelenk	(1.8 T) - 1/01 Nederste/Lower/Unten		
13	5041921 V/H - L/R Bærekugle/Ball joint/Radgelenk	(1.0 - 1.4 T) 2/01 - Nederste/Lower/Unten		
14	5041922 V/H - L/R Bærekugle/Ball joint/Radgelenk	(1.8 T) 2/01 - Nederste/Lower/Unten		
15	5092319 Manchetsæt/Boot kit/Manschetten satz			
16	5102310 For/Front/Vorne Bøsning/Bushing/Buchsen	V/H - L/R		
17	5102311 Bag/Rear/Hinten Bøsning/Bushing/Buchsen	V/H - L/R		
18	5113709 V/H - L/R Stabilisator bolt/Stabilizer bolt/Stabilisator bolzen	Ø14mm. 135 mm.		

POS	 Jumper 244 4/02-			
		Foraksel/Front axle/Vorneachse		
1	5011935 Venstre/Left/Links Bæream/Track control arm/Querlenker	(1.0 - 1.4 T)		
2	5011936 Højre/Right/Rechs Bæream/Track control arm/Querlenker	(1.0 - 1.4 T)		
3	5011937 Venstre/Left/Links Bæream/Track control arm/Querlenker	(1.8 T)		
4	5011938 Højre/Right/Rechs Bæream/Track control arm/Querlenker	(1.8 T)		
5	5031918 V/H - L/R Styrekugle/Tie rod end/Kugelgelenk	16x1,5 RHT - 12/02 Yderste/Outer/Außen		
6	5031919 V/H - L/R Styrekugle/Tie rod end/Axialgelenk	16x1,5 RHT Inderste/Inner		
7	5031935 V/H - L/R Styrekugle/Tie rod end/Kugelgelenk	1/03- Yderste/Outer/Außen		
8	5041921 V/H - L/R Bærekugle/Ball joint/Radgelenk	(1.0 - 1.4 T) Nederste/Lower/Unten		
9	5041922 V/H - L/R Bærekugle/Ball joint/Radgelenk	(1.8 T) Nederste/Lower/Unten		
10	5102310 For/Front/Vorne Bøsning/Bushing/Buchsen	V/H - L/R		
11	5102311 Bag/Rear/Hinten Bøsning/Bushing/Buchsen	V/H - L/R		
POS				







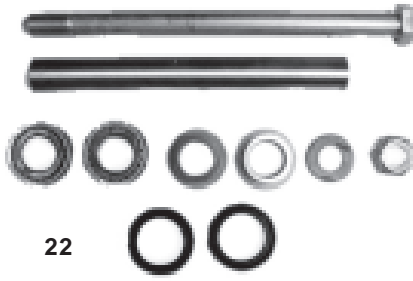





POS	Jumpy 4/96-			
		Foraksel/Front axle/Vorneachse		
1	5011905 Venstre/Left/Links Bæream/Track control arm/Querlenker	Støbejern/Cast iron/Grauguß		1 2
2	5011906 Højre/Right/Rechs Bæream/Track control arm/Querlenker	Støbejern/Cast iron/Grauguß		
3	5031916 V/H - L/R Styrekugle/Tie rod end/Kugelgelenk	14x1,5 RHT Konus/Cone 15mm. Yderste/Outer/Außen		3
4	5031917 V/H - L/R Styrekugle/Tie rod end/Axialgelenk	M14x1,5 RHT Inderste/Inner		4
5	5093712 Manchetsæt/Boot kit/Manschetten satz			
6	5101907 For/Front/Vorne Bøsning/Bushing/Buchsen	V/H - L/R		
7	5101908 Bag/Rear/Hinten Bøsning/Bushing/Buchsen	Venstre/Left/Links		6
8	5101909 Bag/Rear/Hinten Bøsning/Bushing/Buchsen	Højre/Right/Rechs		5
9	5112302 V/H - L/R Ø12mm. 120 mm. Stabilisator/Stabilizer/Stabilisator			7 8 9
POS	LN 1976-5/79 & LN 6/79-7/82 & LNA 6/79-7/82			
		Foraksel/Front axle/Vorneachse		
1	5033702 V/H - L/R Styrekugle/Tie rod end/Kugelgelenk	14x1,5 RHT Yderste/Outer/Außen		1
2	5041901 V/H - L/R Bærekugle/Ball joint/Radgelenk	Nederste/Lower/Unten		2

POS	Nemo (AA_)		
		Foraksel/Front axle/Vorneachse	
1	5012365 Venstre/Left/Links Bærearml/Track control arm/Querlenker		
2	5012366 Højre/Right/Rechs Bærearml/Track control arm/Querlenker		
3	xxxxxx Venstre/Left/Links Styrekugle/Tie rod end/Kugelgelenk		
4	xxxxxx Højre/Right/Rechs Styrekugle/Tie rod end/Kugelgelenk		
POS	Saxo 3/96-		
		Foraksel/Front axle/Vorneachse	
1	5013705 Venstre/Left/Links Bærearml/Track control arm/Querlenker	Stål/Steel/Stahl (-1.6 TU5JP) Nederste/Lower/Unten	
2	5013706 Højre/Right/Rechs Bærearml/Track control arm/Querlenker	Stål/Steel/Stahl (-1.6 TU5JP) Nederste/Lower/Unten	
3	5013707 Venstre/Left/Links Bærearml/Track control arm/Querlenker	Støbejern/Cast iron/Grauguß (1.6 TU5JP)	
4	5013708 Højre/Right/Rechs Bærearml/Track control arm/Querlenker	Støbejern/Cast iron/Grauguß (1.6 TU5JP)	
5	5031922 Venstre/Left/Links Styrekugle/Tie rod end/Axialgelenk	14x1,5 LHT (*) Inderste/Inner	
6	5031923 Højre/Right/Rechs Styrekugle/Tie rod end/Axialgelenk	14x1,5 LHT (*) Inderste/Inner	
7	5031924 Venstre/Left/Links Styrekugle/Tie rod end/Axialgelenk	14x1,5 LHT (**) Inderste/Inner	
8	5031925 Højre/Right/Rechs Styrekugle/Tie rod end/Axialgelenk	14x1,5 LHT (**) Inderste/Inner	
9	5033717 Venstre/Left/Links Styrekugle/Tie rod end/Kugelgelenk	14x1,5 RHT Yderste/Outer/Außen	
10	5033718 Højre/Right/Rechs Styrekugle/Tie rod end/Kugelgelenk	14x1,5 RHT Yderste/Outer/Außen	
			(*) Uden Servo Styling Without Power Steering Ohne Servolenkung
			(**) Med Servo Styling With Power Steering Mit Servolenkung

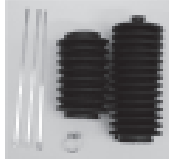
POS	 Visa Super 1978-80
Foraksel/Front axle/Vorneachse	
1	5033702 V/H - L/R 14x1,5 RHT Styrekugle/Tie rod end/Kugelgelenk Yderste/Outer/Außen
2	5041901 V/H - L/R Bærekugle/Ball joint/Radgelenk Nederste/Lower/Unten
	
POS	 Xantia (X1/X2) 3/93- & Xantia Break (X1/X2) 6/95-
Foraksel/Front axle/Vorneachse	
1	5011921 Venstre/Left/Links Bærearmlenke/Track control arm/Querlenker Nederste/Lower/Unten
2	5011922 Højre/Right/Rechs Bærearmlenke/Track control arm/Querlenker Nederste/Lower/Unten
3	5011923 Venstre/Left/Links (Activa) Bærearmlenke/Track control arm/Querlenker Nederste/Lower/Unten
4	5011924 Højre/Right/Rechs (Activa) Bærearmlenke/Track control arm/Querlenker Nederste/Lower/Unten
5	5033717 Venstre/Left/Links 14x1,5 RHT (Alle/All, -Turbo/TD/HDi & 3.0 V6) Styrekugle/Tie rod end/Kugelgelenk Yderste/Outer/Außen
6	5033718 Højre/Right/Rechs 14x1,5 RHT (Alle/All, -Turbo/TD/HDi & 3.0 V6) Styrekugle/Tie rod end/Kugelgelenk Yderste/Outer/Außen
7	5031915 V/H - L/R 14x1,5 RHT (Alle/All, -Turbo/TD/HDi & 3.0 V6) Styrekugle/Tie rod end/Axialgelenk Inderste/Inner
8	5033727 Venstre/Left/Links 16x1,5 RHT (Turbo/TD/HDi & 3.0 V6) Styrekugle/Tie rod end/Kugelgelenk Yderste/Outer/Außen
9	5033728 Højre/Right/Rechs 16x1,5 RHT (Turbo/TD/HDi & 3.0 V6) Styrekugle/Tie rod end/Kugelgelenk Yderste/Outer/Außen
10	5033723 V/H - L/R 16x1,5/12x1,0 RHT (Turbo/TD/HDi & 3.0 V6) Styrekugle/Tie rod end/Axialgelenk Inderste/Inner
	

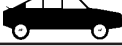

POS		Xantia (X1/X2) 3/93- & Xantia Break (X1/X2) 6/95-
Foraksel/Front axle/Vorneachse		
11	5041912 V/H - L/R Bærekugle/Ball joint/Radgelenk	Ø40mm. RHT Nederste 
12	5091915 CH. - 6778 (**) Manchetsæt/Boot kit/Manschetten satz	
13	5091916 (*) Manchetsæt/Boot kit/Manschetten satz	
14	5093711 CH. 6779- (**) Manchetsæt/Boot kit/Manschetten satz	
15	5101920 For/Front/Vorne Bøsning/Bushing/Buchsen	V/H - L/R 
16	5101921 Bag/Rear/Hinten Bøsning/Bushing/Buchsen	Venstre/Left/Links Indvendig/Inner/Innen18 mm. 
17	5101922 Bag/Rear/Hinten Bøsning/Bushing/Buchsen	Højre/Right/Rechs Indvendig/Inner/Innen18 mm. 
18	5111902 V/H - L/R Stabilisatorstang/Stabilizer rod/Diagonalstrebe	Ø12mm. 355 mm. CH. - 8150 - 3/99 
19	5111910 V/H - L/R Stabilisatorstang/Stabilizer rod/Diagonalstrebe	Ø10mm. 355 mm. - 1/95 
20	5111902 V/H - L/R Stabilisatorstang/Stabilizer rod/Diagonalstrebe	Ø12mm. 355 mm. CH. - 8150 1/95-3/99 
POS		
21	5111903 V/H - L/R Stabilisatorstang/Stabilizer rod/Diagonalstrebe	320 mm. CH. 8151- 3/99 - 
Bagaksel/Rear axle/Hinterachse		
22	5101903 V/H - L/R Bøsningssæt/Bushing set/Buchsen satz	(- Break) 

POS		XM (Y3/Y4) 3/89-10/00 & XM Break (Y3/Y4) 11/91-10/00			
Foraksel/Front axle/Vorneachse					
1		5033717 Venstre/Left/Links Styrekugle/Tie rod end/Kugelgelenk	14x1,5 RHT Yderste/Outer/Außen		
2		5033718 Højre/Right/Rechs Styrekugle/Tie rod end/Kugelgelenk	14x1,5 RHT Yderste/Outer/Außen		
3		5033720 V/H - L/R Styrekugle/Tie rod end/Axialgelenk	Ø18mm. 14x1,5 RHT Inderste/Inner		
4		5033727 Venstre/Left/Links Styrekugle/Tie rod end/Kugelgelenk	16x1,5 RHT Yderste/Outer/Außen		
5		5033728 Højre/Right/Rechs Styrekugle/Tie rod end/Kugelgelenk	16x1,5 RHT Yderste/Outer/Außen		
6		5033732 V/H - L/R Styrekugle/Tie rod end/Axialgelenk	Ø22mm. 16x1,5 Inderste/Inner		
7		5041912 V/H - L/R Bærekugle/Ball joint/Radgelenk	Ø40mm. RHT Nederste/Lower/Unten		
8		5091909 Manchetsæt/Boot kit/Manschetten satz			
9		5113712 V/H - L/R Stabilisatorstang/Stabilizer rod/Diagonalstrebe			
Bagaksel/Rear axle/Hinterachse					
10		5101903 V/H - L/R Bøsningssæt/Bushing set/Buchsen satz			
Foraksel/Front axle/Vorneachse					
1		5011913 Venstre/Left/Links Bærearmlenke/Track control arm/Querlenker	Konus/Cone 16mm. CH. - 7969	- 8/98 (**)	
2		5011914 Højre/Right/Rechs Bærearmlenke/Track control arm/Querlenker	Konus/Cone 16mm. CH. - 7969	- 8/98 (**)	
3		5011915 Venstre/Left/Links Bærearmlenke/Track control arm/Querlenker	Konus/Cone 16mm. CH. - 7969	- 8/98 (*)	
4		5011916 Højre/Right/Rechs Bærearmlenke/Track control arm/Querlenker	Konus/Cone 16mm. CH. - 7969	- 8/98 (*)	
5		5013737 Venstre/Left/Links Bærearmlenke/Track control arm/Querlenker	Konus/Cone 18mm. CH. 7970-	9/98 - (**)	
6		5013738 Højre/Right/Rechs Bærearmlenke/Track control arm/Querlenker	Konus/Cone 18mm. CH. 7970-	9/98 - (**)	
7		5013739 Venstre/Left/Links Bærearmlenke/Track control arm/Querlenker	Konus/Cone 18mm. CH. 7970-	9/98 - (*)	
8		5013740 Højre/Right/Rechs Bærearmlenke/Track control arm/Querlenker	Konus/Cone 18mm. CH. 7970-	9/98 - (*)	
9		5031914 V/H - L/R Styrekugle/Tie rod end/Axialgelenk	14x1,5 RHT Inderste/Inner		
					(*) Uden Servo Styling Without Power Steering Ohne Servolenkung
					(**) Med Servo Styling With Power Steering Mit Servolenkung

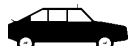

POS		Xsara Picasso (N68) 6/00-	
Foraksel/Front axle/Vorneachse			
1	5011933 Venstre/Left/Links Bæream/Track control arm/Querlenker	Nederste/Lower/Unten	
2	5011934 Højre/Right/Rechs Bæream/Track control arm/Querlenker	Nederste/Lower/Unten	
3	5031934 V/H - L/R Styrekugle/Tie rod end/Axialgelenk	14x1,5 Inderste/Inner	
4	5033702 V/H - L/R Styrekugle/Tie rod end/Kugelgelenk	14x1,5 RHT Yderste/Outer/Außen	
5	5091911 Manchetsæt/Boot kit/Manschetten satz		
6	5093708 Manchetsæt/Boot kit/Manschetten satz		
7	5101905 Bag/Rear/Hinten Bøsning/Bushing/Buchsen	V/H - L/R	
8	5101906 For/Front/Vorne Bøsningssæt/Bushing set/Buchsen satz	V/H - L/R	
9	5111901 V/H - L/R Stabilisatorstang/Stabilizer rod/Diagonalstrebe	301 mm.	
Bagaksel/Rear axle/Hinterachse			
10	5101925 Bag/Rear/Hinten Bøsning/Bushing/Buchsen	V/H - L/R	
POS			
11	5101927 For/Front/Vorne Bøsning/Bushing/Buchsen	Venstre/Left/Links	
12	5101928 For/Front/Vorne Bøsning/Bushing/Buchsen	Højre/Right/Rechs	









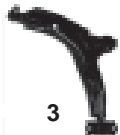

POS		ZX 3/91-1997 & ZX Break 10/93-1997		
Foraksel/Front axle/Vorneachse				
1		5011913 Venstre/Left/Links Bæream/Track control arm/Querlenker	Konus/Cone 16mm. (**)	
2		5011914 Højre/Right/Rechs Bæream/Track control arm/Querlenker	Konus/Cone 16mm. (**)	
3		5011915 Venstre/Left/Links Bæream/Track control arm/Querlenker	Konus/Cone 16mm. (*)	
4		5011916 Højre/Right/Rechs Bæream/Track control arm/Querlenker	Konus/Cone 16mm. (*)	
5		5021908 U Ex. 1.9 Tandstang/Steering rack/Zahnstange		
6		5031914 V/H - L/R Styrekugle/Tie rod end/Axialgelenk	14x1,5 RHT Inderste/Inner	
7		5033702 V/H - L/R Styrekugle/Tie rod end/Kugelgelenk	14x1,5 RHT Yderste/Outer/Außen	
8		5041916 V/H - L/R Bærekugle/Ball joint/Radgelenk	Konus/Cone 16mm. (*) Nederste/Lower/Unten	
9		5041917 V/H - L/R Bærekugle/Ball joint/Radgelenk	Konus/Cone 16mm. (**) Nederste/Lower/Unten	
10		5091907 (*) Manchetsæt/Boot kit/Manschetten satz		
11		5091908 (**) Manchetsæt/Boot kit/Manschetten satz		
Bagaksel/Rear axle/Hinterachse				
12		5101905 Bag/Rear/Hinten V/H - L/R Bøsning/Bushing/Buchsen		
13		5101906 For/Front/Vorne V/H - L/R Bøsningssæt/Bushing set/Buchsen satz		
14		5111901 V/H - L/R 301 mm. Stabilisatorstang/Stabilizer rod/Diagonalstrebe		
15		5101925 Bag/Rear/Hinten V/H - L/R Bøsning/Bushing/Buchsen		
16		5101927 For/Front/Vorne Venstre/Left/Links Bøsning/Bushing/Buchsen		
17		5101928 For/Front/Vorne Højre/Right/Rechs Bøsning/Bushing/Buchsen		
<p>(*) Uden Servo Styring Without Power Steering Ohne Servolenkung</p> <p>(**) Med Servo Styring With Power Steering Mit Servolenkung</p>				

POS	
POS	





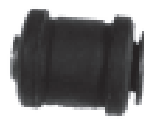
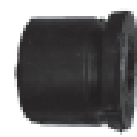



POS		1210	5/83- & 1310	5/83-
1		Foraksel/Front axle/Vorneachse		
		5043907	V/H - L/R	
		Bærekugle/Ball joint/Radgelenk Øverste/Upper/Oben		
		 1		
POS				

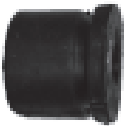





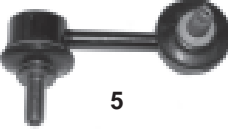
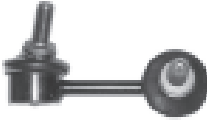





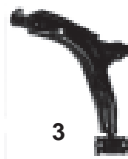

DACIA

POS	
POS	





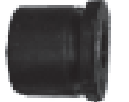



POS	 Espero 2/95-6/99			
		Foraksel/Front axle/Vorneachse		
1	5003626 Venstre/Left/Links Styrestang/Steering rod/Spurstange			
2	5003629 Højre/Right/Rechs Styrestang/Steering rod/Spurstange			
3	5013605 Venstre/Left/Links Bærearmlenke/Track control arm/Querlenker			
4	5013606 Højre/Right/Rechs Bærearmlenke/Track control arm/Querlenker			
5	5033611 Venstre/Left/Links Styrekugle/Tie rod end/Kugelgelenk	16x1,5 RHT Yderste/Outer/Außen		
6	5033612 Højre/Right/Rechs Styrekugle/Tie rod end/Kugelgelenk	16x1,5 RHT Yderste/Outer/Außen		
7	5033622 16x1,5 Mellemlenke/Intermediate link/Zwischenglied			
8	5043607 V/H - L/R Bærekugle/Ball joint/Radgelenk	Nederste/Lower/Unten		
9	5095001 Manchetsæt/Boot kit/Manschetten satz			
10	5103608 For/Front/Vorne Bøsning/Bushing/Buchsen	V/H - L/R		
11	5103609 Bag/Rear/Hinten Bøsning/Bushing/Buchsen	V/H - L/R		
POS				
12	5113603 V/H - L/R 190 mm. Stabilisator bolt/Stabilizer bolt/Stabilisator bolzen			







POS	Kalos 9/02-			
		Foraksel/Front axle/Vorneachse		
1	5015007 Venstre/Left/Links Bæream/Track control arm/Querlenker	Nederste/Lower/Unten		
2	5015008 Højre/Right/Rechs Bæream/Track control arm/Querlenker	Nederste/Lower/Unten		
3	5035005 Venstre/Left/Links Styrekugle/Tie rod end/Kugelgelenk	12x1,5 RHT Yderste/Outer/Außen		
4	5035006 Højre/Right/Rechs Styrekugle/Tie rod end/Kugelgelenk	12x1,5 RHT Yderste/Outer/Außen		
5	5045002 V/H - L/R Bærekugle/Ball joint/Radgelenk	Nederste/Lower/Unten		
6	5115006 V/H - L/R 262 mm. Stabilisatorstang/Stabilizer rod/Diagonalstrebe			
POS	Lanos 5/97-			
		Foraksel/Front axle/Vorneachse		
1	5003626 Venstre/Left/Links Styrestang/Steering rod/Spurstange			
2	5003629 Højre/Right/Rechs Styrestang/Steering rod/Spurstange			
3	5013605 Venstre/Left/Links Bæream/Track control arm/Querlenker			
4	5013606 Højre/Right/Rechs Bæream/Track control arm/Querlenker			
5	5033611 Venstre/Left/Links Styrekugle/Tie rod end/Kugelgelenk	16x1,5 RHT Yderste/Outer/Außen		
6	5033612 Højre/Right/Rechs Styrekugle/Tie rod end/Kugelgelenk	16x1,5 RHT Yderste/Outer/Außen		
7	5033622 16x1,5 Mellemlid/Intermediate link/Zwischenglied			
8	5043607 V/H - L/R Bærekugle/Ball joint/Radgelenk	Nederste/Lower/Unten		
9	5095001 Manchetsæt/Boot kit/Manschetten satz			
10	5103608 For/Front/Vorne Bøsning/Bushing/Buchsen	V/H - L/R		







POS	 Lanos 5/97-
Foraksel/Front axle/Vorneachse	
11	5103609 Bag/Rear/Hinten V/H - L/R Bøsning/Bushing/Buchsen
12	5113603 V/H - L/R 190 mm. Stabilisator bolt/Stabilizer bolt/Stabilisator bolzen
	 
	<p style="text-align: center;">11 12</p>
POS	 Leganza 6/97-
Foraksel/Front axle/Vorneachse	
1	5035002 V/H - L/R 14x1,5 RHT Styrekugle/Tie rod end/Kugelgelenk Yderste/Outer/Außen
2	5035003 V/H - L/R 14x1,5 RHT Styrekugle/Tie rod end/Axialgelenk Inderste/Inner
3	5043607 V/H - L/R Bærekugle/Ball joint/Radgelenk Nederste/Lower/Unten
4	5093611 Saginaw Manchetsæt/Boot kit/Manschetten satz
5	5115003 Venstre/Left/Links Stabilisator bolt/Stabilizer bolt/Stabilisator bolzen
6	5115004 Højre/Right/Rechs Stabilisator bolt/Stabilizer bolt/Stabilisator bolzen
Bagaksel/Rear axle/Hinterachse	
7	5115005 V/H - L/R Stabilisator bolt/Stabilizer bolt/Stabilisator bolzen
	      
	<p style="text-align: center;">1 2 3 4 5 6 7</p>







POS	Matiz 9/98-		
		Foraksel/Front axle/Vorneachse	
1	5015001 V/H - L/R Bærearml/Track control arm/Querlenker		 1
2	5035001 V/H - L/R 14x1,5 Styrekugle/Tie rod end/Kugelgelenk	Yderste/Outer/Außen	 2
3	5035004 V/H - L/R 12x1,5 Styrekugle/Tie rod end/Axialgelenk	Inderste/Inner	
4	5093202 Manchetsæt/Boot kit/Manschetten satz		 3  4
POS	Nexia 2/95-8/97		
		Foraksel/Front axle/Vorneachse	
1	5003626 Venstre/Left/Links Styrestang/Steering rod/Spurstange		 1
2	5003629 Højre/Right/Rechs Styrestang/Steering rod/Spurstange		 2
3	5013605 Venstre/Left/Links Bærearml/Track control arm/Querlenker		 3
4	5013606 Højre/Right/Rechs Bærearml/Track control arm/Querlenker		 4
5	5033611 Venstre/Left/Links Styrekugle/Tie rod end/Kugelgelenk	16x1,5 RHT Yderste/Outer/Außen	 5
6	5033612 Højre/Right/Rechs Styrekugle/Tie rod end/Kugelgelenk	16x1,5 RHT Yderste/Outer/Außen	 6
7	5033622 16x1,5 Mellemlid/Intermediate link/Zwischenglied		 7
8	5043607 V/H - L/R Bærekugle/Ball joint/Radgelenk	Nederste/Lower/Unten	 8
9	5103608 For/Front/Vorne Bøsning/Bushing/Buchsen	V/H - L/R	 9
10	5103609 Bag/Rear/Hinten Bøsning/Bushing/Buchsen	V/H - L/R	 10
11	5113603 V/H - L/R 190 mm. Stabilisator bolt/Stabilizer bolt/Stabilisator bolzen		 11

POS	Nubira 5/97-			
Foraksel/Front axle/Vorneachse				
1	5015003 Venstre/Left/Links Bæream/Track control arm/Querlenker	- 12/99		
2	5015004 Højre/Right/Rechs Bæream/Track control arm/Querlenker	- 12/99		
3	5015005 Venstre/Left/Links Bæream/Track control arm/Querlenker	1/00 -		
4	5015006 Højre/Right/Rechs Bæream/Track control arm/Querlenker	1/00 -		
5	5035002 V/H - L/R Styrekugle/Tie rod end/Kugelgelenk	14x1,5 RHT Yderste/Outer/Außen		
6	5035003 V/H - L/R Styrekugle/Tie rod end/Axialgelenk	14x1,5 RHT Inderste/Inner		
7	5045001 V/H - L/R Bærekugle/Ball joint/Radgelenk			
8	5093611 Saginaw Manchetsæt/Boot kit/Manschetten satz			
9	5105001 For/Front/Vorne V/H - L/R Bøsning/Bushing/Buchsen Nederste/Lower/Unten			
10	5105002 Bag/Rear/Hinten V/H - L/R Bøsning/Bushing/Buchsen Nederste/Lower/Unten			
11	5115001 V/H - L/R Stabilisatorstang/Stabilizer rod/Diagonalstrebe			
POS				
Bagaksel/Rear axle/Hinterachse				
12	5115002 V/H - L/R 247 mm. Stabilisatorstang/Stabilizer rod/Diagonalstrebe			

POS	 Nubira 7/03-								
POS	 Tico 2/95-								
	<p>Foraksel/Front axle/Vorneachse</p> <table border="0"> <tr> <td data-bbox="140 1335 161 1357">1</td> <td data-bbox="204 1335 638 1386"> 5015001 V/H - L/R Bærearm/Track control arm/Querlenker </td> <td data-bbox="975 1335 1334 1435">  </td> <td data-bbox="1155 1435 1166 1458">1</td> </tr> <tr> <td data-bbox="140 1413 161 1435">2</td> <td data-bbox="204 1413 906 1464"> 5035001 V/H - L/R 14x1,5 Styrekugle/Tie rod end/Kugelgelenk Yderste/Outer/Außen </td> <td data-bbox="1107 1503 1230 1653">  </td> <td data-bbox="1155 1644 1166 1666">2</td> </tr> </table>	1	5015001 V/H - L/R Bærearm/Track control arm/Querlenker		1	2	5035001 V/H - L/R 14x1,5 Styrekugle/Tie rod end/Kugelgelenk Yderste/Outer/Außen		2
1	5015001 V/H - L/R Bærearm/Track control arm/Querlenker		1						
2	5035001 V/H - L/R 14x1,5 Styrekugle/Tie rod end/Kugelgelenk Yderste/Outer/Außen		2						



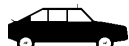

POS	 Applause A101 6/89-7/97 & Applause A111 6/89-7/97
Foraksel/Front axle/Vorneachse	
1	<p>5035109 Venstre/Left/Links 12x1,25 RHT Konus/Cone 11,8mm. Styrekugle/Tie rod end/Kugelgelenk Yderste/Outer/Außen</p>
2	<p>5035110 Højre/Right/Rechs 12x1,25 RHT Konus/Cone 11,8mm. Styrekugle/Tie rod end/Kugelgelenk Yderste/Outer/Außen</p>
	 <p style="text-align: center;">1</p>  <p style="text-align: center;">2</p>
POS	 Applause II 7/97-
Foraksel/Front axle/Vorneachse	
1	<p>5035109 Venstre/Left/Links 12x1,25 RHT Konus/Cone 11,8mm. Styrekugle/Tie rod end/Kugelgelenk Yderste/Outer/Außen</p>
2	<p>5035110 Højre/Right/Rechs 12x1,25 RHT Konus/Cone 11,8mm. Styrekugle/Tie rod end/Kugelgelenk Yderste/Outer/Außen</p>
	 <p style="text-align: center;">1</p>  <p style="text-align: center;">2</p>

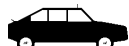



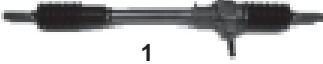



POS	 Charade G100 2/87-1/93 & Charade G101 2/87-1/93			
Foraksel/Front axle/Vorneachse				
1	5035109 Venstre/Left/Links Styrekugle/Tie rod end/Kugelgelenk	12x1,25 RHT Konus/Cone 11,8mm. Yderste/Outer/Außen		 1  2  3
2	5035110 Højre/Right/Rechs Styrekugle/Tie rod end/Kugelgelenk	12x1,25 RHT Konus/Cone 11,8mm. Yderste/Outer/Außen		
3	5035111 U V/H - L/R Styrekugle/Tie rod end/Axialgelenk	12x1,25 RHT - 1/89 (*) Inderste/Inner		
POS	 Charade G200 1/93			
Foraksel/Front axle/Vorneachse				
1	5035109 Venstre/Left/Links Styrekugle/Tie rod end/Kugelgelenk	12x1,25 RHT Konus/Cone 11,8mm. Yderste/Outer/Außen		 1  2
2	5035110 Højre/Right/Rechs Styrekugle/Tie rod end/Kugelgelenk	12x1,25 RHT Konus/Cone 11,8mm. Yderste/Outer/Außen		

POS	 Charmant A35/A55/A60 10/81-7/87		
	Foraksel/Front axle/Vorneachse		
1	5034501 U V/H - L/R 14x1,5 Styrekugle/Tie rod end/Kugelgelenk	Yderste/Outer/Außen	 <p style="text-align: center;">1</p>  <p style="text-align: center;">2</p>  <p style="text-align: center;">3</p>
2	5044504 U V/H - L/R Bærekugle/Ball joint/Radgelenk	Nederste/Lower/Unten	
3	5113204 V/H - L/R 130 mm. Stabilisator bolt/Stabilizer bolt/Stabilisator bolzen		
POS	 Move 10/96-		
	Foraksel/Front axle/Vorneachse		
1	5035109 Venstre/Left/Links Styrekugle/Tie rod end/Kugelgelenk	12x1,25 RHT Konus/Cone 11,8mm. Yderste/Outer/Außen	 <p style="text-align: center;">1</p>  <p style="text-align: center;">2</p>
2	5035110 Højre/Right/Rechs Styrekugle/Tie rod end/Kugelgelenk	12x1,25 RHT Konus/Cone 11,8mm. Yderste/Outer/Außen	

POS	
POS	

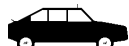
POS	126 1972-78			
	Foraksel/Front axle/Vorneachse			
1	5032305 U V/H - L/R Styrekugle/Tie rod end/Axialgelenk	14x1 LHT Inderste/Inner		
2	5092301 Manchetsæt/Boot kit/Manschetten satz			
	POS 127 1971-12/86 & 127 Brazil 1971-12/86 & Fiorino (147) 1978-			
	Foraksel/Front axle/Vorneachse			
1	5012301 V/H - L/R Bærearmlenke/Track control arm/Querlenker			
2	5022301 U - 10/82 Tandstang/Steering rack/Zahnstange			
3	5032307 V/H - L/R 14x1 RHT Styrekugle/Tie rod end/Kugelgelenk	- 10/82 Yderste/Outer/Außen		
4	5032308 V/H - L/R 12x1,5 RHT Styrekugle/Tie rod end/Kugelgelenk	11/82 - Yderste/Outer/Außen		
5	5092301 Manchetsæt/Boot kit/Manschetten satz			
	POS 128 1969-12/84			
	Foraksel/Front axle/Vorneachse			
1	5012303 V/H - L/R 4/78 - Bærearmlenke/Track control arm/Querlenker			
2	5022301 U Tandstang/Steering rack/Zahnstange			
3	5032309 V/H - L/R 14x1 RHT Styrekugle/Tie rod end/Kugelgelenk	- 3/78 Yderste/Outer/Außen		
4	5092301 Manchetsæt/Boot kit/Manschetten satz			



POS	 128 3P 3/72-2/81 & 128 coupe 3/72-2/81
Foraksel/Front axle/Vorneachse	
1	5022301 U Tandstang/Steering rack/Zahnstange
2	5032309 V/H - L/R - 3/78 14x1 RHT Styrekugle/Tie rod end/Kugelgelenk Yderste/Outer/Außen
3	5092301 Manchetsæt/Boot kit/Manschetten satz
	 1  2  3
POS	 131 10/74-6/82
Foraksel/Front axle/Vorneachse	
1	5092301 Manchetsæt/Boot kit/Manschetten satz
	 1







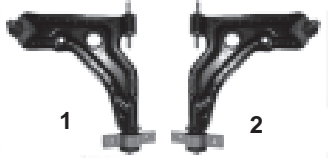
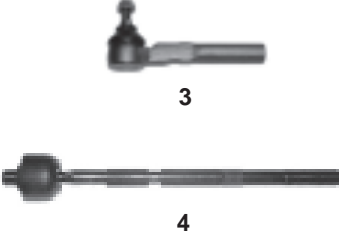

POS	 132 1972-12/82 & Argenta 6/81-7/86			
Foraksel/Front axle/Vorneachse				
1	5032315 V/H - L/R Styrekugle/Tie rod end/Kugelgelenk	16x1 LHT Yderste/Outer/Außen		
2	5042301 V/H - L/R Bærekugle/Ball joint/Radgelenk	Øverste/Upper/Oben		2
3	5042302 V/H - L/R Bærekugle/Ball joint/Radgelenk	Nederste/Lower/Unten		3
POS  147 & 147 Fiorino 10/76-12/95				
Foraksel/Front axle/Vorneachse				
1	5012301 V/H - L/R Bæream/Track control arm/Querlenker	Nederste/Lower/Unten		1
2	5032307 V/H - L/R - 10/82 Styrekugle/Tie rod end/Kugelgelenk	14x1 RHT Yderste/Outer/Außen		2
3	5032308 V/H - L/R 10/82 - Styrekugle/Tie rod end/Kugelgelenk	12x1,5 RHT Yderste/Outer/Außen		3
4	5092301 Manchetsæt/Boot kit/Manschetten satz			4

POS	500 10/07-			
POS	Barchetta 6/95-			
		Foraksel/Front axle/Vorneachse		
1	5012321 Venstre/Left/Links Bæream/Track control arm/Querlenker			
2	5012322 Højre/Right/Rechs Bæream/Track control arm/Querlenker			
3	5032344 V/H - L/R Styrekugle/Tie rod end/Kugelgelenk		12x1,5 RHT Yderste/Outer/Außen	
4	5032346 V/H - L/R (**) Styrekugle/Tie rod end/Axialgelenk		12x1,5 RHT Inderste/Inner	
5	5092311 (**) Manchetsæt/Boot kit/Manschetten satz			
6	5102301 For/Front/Vorne Bøsning/Bushing/Buchsen		V/H - L/R	
7	5102308 Bag/Rear/Hinten Bøsning/Bushing/Buchsen		Venstre/Left/Links	
8	5102309 Bag/Rear/Hinten Bøsning/Bushing/Buchsen		Højre/Right/Rechs	
				(**) Med Servo Styring With Power Steering Mit Servolenkung

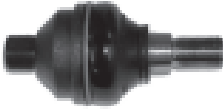
POS	Bravo 4/07-		
POS	Cinquecento 7/91-1/98		
	<p>Foraksel/Front axle/Vorneachse</p> <table border="0"> <tr> <td style="vertical-align: top;"> <p>1 5012315 Venstre/Left/Links Bæream/Track control arm/Querlenker</p> <p>2 5012316 Højre/Right/Rechs Bæream/Track control arm/Querlenker</p> <p>3 5032303 V/H - L/R Styrekugle/Tie rod end/Kugelgelenk</p> <p>4 5032342 V/H - L/R Styrekugle/Tie rod end/Axialgelenk</p> <p>5 5092309 Manchetsæt/Boot kit/Manschetten satz</p> <p>6 5102301 For/Front/Vorne Bøsning/Bushing/Buchsen</p> <p>7 5102302 Bag/Rear/Hinten Bøsning/Bushing/Buchsen</p> <p>8 5112301 V/H - L/R Ø12mm. 100 mm. Stabilisator/Stabilizer/Stabilisator</p> </td> <td style="vertical-align: top; text-align: center;"> <p>1 2</p> <p>3</p> <p>4</p> <p>5</p> <p>6</p> <p>7</p> <p>8</p> </td> </tr> </table>	<p>1 5012315 Venstre/Left/Links Bæream/Track control arm/Querlenker</p> <p>2 5012316 Højre/Right/Rechs Bæream/Track control arm/Querlenker</p> <p>3 5032303 V/H - L/R Styrekugle/Tie rod end/Kugelgelenk</p> <p>4 5032342 V/H - L/R Styrekugle/Tie rod end/Axialgelenk</p> <p>5 5092309 Manchetsæt/Boot kit/Manschetten satz</p> <p>6 5102301 For/Front/Vorne Bøsning/Bushing/Buchsen</p> <p>7 5102302 Bag/Rear/Hinten Bøsning/Bushing/Buchsen</p> <p>8 5112301 V/H - L/R Ø12mm. 100 mm. Stabilisator/Stabilizer/Stabilisator</p>	<p>1 2</p> <p>3</p> <p>4</p> <p>5</p> <p>6</p> <p>7</p> <p>8</p>
<p>1 5012315 Venstre/Left/Links Bæream/Track control arm/Querlenker</p> <p>2 5012316 Højre/Right/Rechs Bæream/Track control arm/Querlenker</p> <p>3 5032303 V/H - L/R Styrekugle/Tie rod end/Kugelgelenk</p> <p>4 5032342 V/H - L/R Styrekugle/Tie rod end/Axialgelenk</p> <p>5 5092309 Manchetsæt/Boot kit/Manschetten satz</p> <p>6 5102301 For/Front/Vorne Bøsning/Bushing/Buchsen</p> <p>7 5102302 Bag/Rear/Hinten Bøsning/Bushing/Buchsen</p> <p>8 5112301 V/H - L/R Ø12mm. 100 mm. Stabilisator/Stabilizer/Stabilisator</p>	<p>1 2</p> <p>3</p> <p>4</p> <p>5</p> <p>6</p> <p>7</p> <p>8</p>		

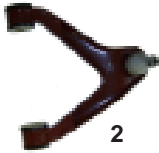
POS	Coupe 3/94-		
Foraksel/Front axle/Vorneachse			
1	5011001 Venstre/Left/Links Bærearmlenke/Track control arm/Querlenker		
2	5011002 Højre/Right/Rechs Bærearmlenke/Track control arm/Querlenker		
3	5031006 V/H - L/R Styrekugle/Tie rod end/Axialgelenk	12x1,5 RHT Inderste/Inner	
4	5032333 Venstre/Left/Links Styrekugle/Tie rod end/Kugelgelenk	12x1,5 RHT Yderste/Outer/Außen	
5	5032334 Højre/Right/Rechs Styrekugle/Tie rod end/Kugelgelenk	12x1,5 RHT Yderste/Outer/Außen	
6	5092311 Manchetsæt/Boot kit/Manschetten satz		
7	5101001 Bag/Rear/Hinten Bøsning/Bushing/Buchsen	Venstre/Left/Links	
8	5101002 Bag/Rear/Hinten Bøsning/Bushing/Buchsen	Højre/Right/Rechs	
9	5101003 For/Front/Vorne Bøsning/Bushing/Buchsen	V/H - L/R	
10	5112301 V/H - L/R Ø12mm. 100 mm. Stabilisator/Stabilizer/Stabilisator		
POS		Bagaksel/Rear axle/Hinterachse	
11	5102318 V/H - L/R Bøsningssæt/Bushing set/Buchsen satz		

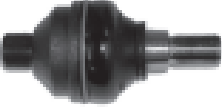

POS	 Croma 4/86-12/96		
		Foraksel/Front axle/Vorneachse	
1	5012313 Venstre/Left/Links Bæream/Track control arm/Querlenker		
2	5012314 Højre/Right/Rechs Bæream/Track control arm/Querlenker		
3	5032330 V/H - L/R Styrekugle/Tie rod end/Kugelgelenk	14x1,5 RHT Yderste/Outer/Außen	
4	5032331 V/H - L/R Styrekugle/Tie rod end/Axialgelenk	14x1,5 RHT Inderste/Inner	
5	5042311 V/H - L/R Bærekugle/Ball joint/Radgelenk	Ø13mm. 12x1,25 RHT Nederste/Lower/Unten	
POS	 Croma 6/05-		





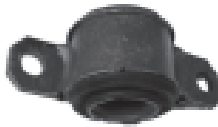

POS		Iveco Daily 1/78- & Iveco Daily Turbo 4x4 1987-		
		Foraksel/Front axle/Vorneachse		
1		5032372 V/H - L/R CH. - 5256682 Styrekugle/Tie rod end/Kugelgelenk	16x1,5 RHT Yderste/Outer/Außen	
2		5032373 V/H - L/R Styrekugle/Tie rod end/Kugelgelenk	CH. 5256683- Yderste/Outer/Außen	
3		5042306 V/H - L/R Bærekugle/Ball joint/Radgelenk	Øverste/Upper/Oben	
				1 2 3
POS		Iveco Daily II 5/99-		
		Foraksel/Front axle/Vorneachse		
1		5012357 Venstre/Left/Links Bærearmlenke/Track control arm/Querlenker	Øverste/Upper/Oben	
2		5012358 Højre/Right/Rechts Bærearmlenke/Track control arm/Querlenker	Øverste/Upper/Oben	
3		5012359 Venstre/Left/Links Bærearmlenke/Track control arm/Querlenker	Nederste/Lower/Unten	
4		5012360 Højre/Right/Rechts Bærearmlenke/Track control arm/Querlenker	Nederste/Lower/Unten	
5		5032373 V/H - L/R Styrekugle/Tie rod end/Kugelgelenk	Yderste/Outer/Außen	
6		5032377 V/H - L/R Styrekugle/Tie rod end/Axialgelenk	16x1,5 RHT Inderste/Inner	
7		5042306 V/H - L/R Bærekugle/Ball joint/Radgelenk	Øverste/Upper/Oben	
				
				5 7



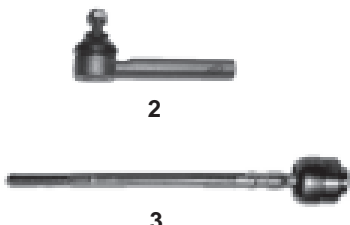

POS	Doblo 3/01-			
		Foraksel/Front axle/Vorneachse		
1	5012351	Venstre/Left/Links Bæream/Track control arm/Querlenker	- 8/01	
2	5012352	Højre/Right/Rechs Bæream/Track control arm/Querlenker	- 8/01	
3	5012361	Venstre/Left/Links Bæream/Track control arm/Querlenker	9/01 - Nederste/Lower/Unten	
4	5012362	Højre/Right/Rechs Bæream/Track control arm/Querlenker	9/01 - Nederste/Lower/Unten	
5	5032359	V/H - L/R Styrekugle/Tie rod end/Kugelgelenk	14x1,5 RHT Yderste/Outer/Außen	
6	5032361	V/H - L/R Styrekugle/Tie rod end/Axialgelenk	Inderste/Inner	
7	5042319	V/H - L/R - 8/01 Bærekugle/Ball joint/Radgelenk	Nederste/Lower/Unten	
8	5042320	V/H - L/R 9/01 - Bærekugle/Ball joint/Radgelenk	Nederste/Lower/Unten	
9	5102303	For/Front/Vorne Bøsning/Bushing/Buchsen	V/H - L/R	
10	5102319	Bag/Rear/Hinten Bøsning/Bushing/Buchsen	Venstre/Left/Links	
11	5102320	Bag/Rear/Hinten Bøsning/Bushing/Buchsen	Højre/Right/Rechs	
POS				
12	5112311	V/H - L/R 118 mm. Stabilisatorstang/Stabilizer rod/Diagonalstrebe		
		Bagaksel/Rear axle/Hinterachse		
13	5112306	V/H - L/R 133 mm. Stabilisator/Stabilizer/Stabilisator		

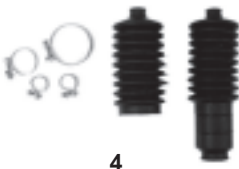
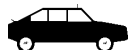
POS	Ducato 3/94-4/02			
Foraksel/Front axle/Vorneachse				
11	5041914 V/H - L/R Bærekugle/Ball joint/Radgelenk	(1.0 - 1.4 T) - 1/01 Nederste/Lower/Unten		
12	5041915 V/H - L/R Bærekugle/Ball joint/Radgelenk	(1.8 T) - 1/01 Nederste/Lower/Unten		
13	5041921 V/H - L/R Bærekugle/Ball joint/Radgelenk	(1.0 - 1.4 T) 2/01 - Nederste/Lower/Unten		
14	5041922 V/H - L/R Bærekugle/Ball joint/Radgelenk	(1.8 T) 2/01 - Nederste/Lower/Unten		
15	5092315 (1.8/2.0 4wd) Manchetsæt/Boot kit/Manschetten satz			
16	5092318 (1.9 D/1.9 TD/2.0 D/2.5 D) Manchetsæt/Boot kit/Manschetten satz			
17	5092319 (2.5 TD/2.8 D/2.8 TD) Manchetsæt/Boot kit/Manschetten satz			
18	5102310 For/Front/Vorne Bøsning/Bushing/Buchsen	V/H - L/R		
19	5102311 Bag/Rear/Hinten Bøsning/Bushing/Buchsen	V/H - L/R		
20	5113709 V/H - L/R Ø14mm. 135 mm. Stabilisator bolt/Stabilizer bolt/Stabilisator bolzen			
POS Ducato 4/02-				
Foraksel/Front axle/Vorneachse				
1	5011935 Venstre/Left/Links Bærearmlenke/Track control arm/Querlenker	(1.0 - 1.4 T)		
2	5011936 Højre/Right/Rechs Bærearmlenke/Track control arm/Querlenker	(1.0 - 1.4 T)		
3	5011937 Venstre/Left/Links Bærearmlenke/Track control arm/Querlenker	(1.8 T)		
4	5011938 Højre/Right/Rechs Bærearmlenke/Track control arm/Querlenker	(1.8 T)		
5	5031918 V/H - L/R - 12/02 Styrekugle/Tie rod end/Kugelgelenk	16x1,5 RHT Yderste/Outer/Außen		
6	5031919 V/H - L/R - 12/02 Styrekugle/Tie rod end/Axialgelenk	16x1,5 RHT Inderste/Inner		
7	5031935 V/H - L/R 1/03 - Styrekugle/Tie rod end/Kugelgelenk	Yderste/Outer/Außen		
8	5041921 V/H - L/R (1.0 - 1.4 T) Bærekugle/Ball joint/Radgelenk	Nederste/Lower/Unten		
9	5041922 V/H - L/R (1.8 T) Bærekugle/Ball joint/Radgelenk	Nederste/Lower/Unten		
10	5102310 For/Front/Vorne Bøsning/Bushing/Buchsen	V/H - L/R		

FIAT

POS	 Ducato 4/02-		
11	Foraksel/Front axle/Vorneachse 5102311 Bag/Rear/Hinten Bøsning/Bushing/Buchsen	V/H - L/R	 11
POS	 Ducato 7/06-		









POS	 Duna 11/85-12/91	
	Foraksel/Front axle/Vorneachse	
1	5012344 V/H - L/R Bærearml/Track control arm/Querlenker	 1
2	5032308 V/H - L/R Styrekgule/Tie rod end/Kugelgelenk	12x1,5 RHT Yderste/Outer/Außen
3	5032347 V/H - L/R Styrekgule/Tie rod end/Axialgelenk	12x1,5 RHT Inderste/Inner
4	5092301 Manchetsæt/Boot kit/Manschetten satz	 2  3  4
POS	 Fiorino (146) 5/88-12/98	
	Foraksel/Front axle/Vorneachse	
1	5012344 V/H - L/R Bærearml/Track control arm/Querlenker	 1

POS	 Fiorino 2/08-
	<p>Foraksel/Front axle/Vorneachse</p> <p>1 5012365 Venstre/Left/Links Bæream/Track control arm/Querlenker</p> <p>2 5012366 Højre/Right/Rechs Bæream/Track control arm/Querlenker</p> <p>3 xxxxxxx Venstre/Left/Links Styrekugle/Tie rod end/Kugelgelenk</p> <p>4 xxxxxxx Højre/Right/Rechs Styrekugle/Tie rod end/Kugelgelenk</p> <div style="display: flex; justify-content: space-around; align-items: center;">   </div>
POS	

POS	Idea 1/04-			
		Foraksel/Front axle/Vorneachse		
1	5012367 Venstre/Left/Links Bærearml/Track control arm/Querlenker	Nederste/Lower/Unten		
2	5012368 Højre/Right/Rechs Bærearml/Track control arm/Querlenker	Nederste/Lower/Unten		
3	5032378 V/H - L/R 258 mm. Styrekugle/Tie rod end/Axialgelenk	14x1,5 RHT Inderste/Inner		
4	5032379 V/H - L/R Styrekugle/Tie rod end/Kugelgelenk	14x1,5 RHT Yderste/Outer/Außen		
POS	Marea 9/96-			
		Foraksel/Front axle/Vorneachse		
1	5011001 Venstre/Left/Links Bærearml/Track control arm/Querlenker			
2	5011002 Højre/Right/Rechs Bærearml/Track control arm/Querlenker			
3	5031917 V/H - L/R Styrekugle/Tie rod end/Axialgelenk	M14x1,5 RHT Inderste/Inner		
4	5032359 V/H - L/R (1.2/1.4/1.6/1.8) Styrekugle/Tie rod end/Kugelgelenk	14x1,5 RHT Yderste/Outer/Außen		
5	5032360 V/H - L/R (2.0/1.9 TD/1.9 JTD/2.4 TD/2.4 JTD) Styrekugle/Tie rod end/Kugelgelenk	14x1,5 RHT Yderste/Outer/Außen		
6	5092311 Manchetsæt/Boot kit/Manschetten satz			
7	5101001 Bag/Rear/Hinten Bøsning/Bushing/Buchsen	Venstre/Left/Links		
8	5101002 Bag/Rear/Hinten Bøsning/Bushing/Buchsen	Højre/Right/Rechs		
9	5101003 For/Front/Vorne Bøsning/Bushing/Buchsen	V/H - L/R		
10	5112307 V/H - L/R 275 mm. Stabilisator/Stabilizer/Stabilisator			

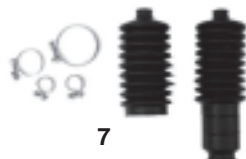











POS	Marea 9/96-		
		Bagaksel/Rear axle/Hinterachse	
11	5102318 V/H - L/R Bøsningssæt/Bushing set/Buchsen satz		<p style="text-align: center;">11</p>
POS	Multipla 4/99-		
		Foraksel/Front axle/Vorneachse	
1	5012345 Venstre/Left/Links Bæream/Track control arm/Querlenker		<p style="text-align: center;">1 2</p>
2	5012346 Højre/Right/Rechs Bæream/Track control arm/Querlenker		
3	5031917 V/H - L/R Styrekugle/Tie rod end/Axialgelenk	M14x1,5 RHT Inderste/Inner	<p style="text-align: center;">3</p>
4	5032359 V/H - L/R Styrekugle/Tie rod end/Kugelgelenk	14x1,5 RHT Yderste/Outer/Außen	<p style="text-align: center;">4</p>
5	5092320 Manchetsæt/Boot kit/Manschetten satz		<p style="text-align: center;">5</p>
6	5102325 For/Front/Vorne Bøsning/Bushing/Buchsen	Venstre/Left/Links	<p style="text-align: center;">6 7</p>
7	5102326 For/Front/Vorne Bøsning/Bushing/Buchsen	Højre/Right/Rechs	
8	5102327 Bag/Rear/Hinten Bøsning/Bushing/Buchsen	Venstre/Left/Links	<p style="text-align: center;">8 9</p>
9	5102328 Bag/Rear/Hinten Bøsning/Bushing/Buchsen	Højre/Right/Rechs	
10	5112307 V/H - L/R 275 mm. Stabilisator/Stabilizer/Stabilisator		<p style="text-align: center;">10</p>

POS	Palio 4/96- & Palio Weekend 4/96-			
Foraksel/Front axle/Vorneachse				
1	5012335 Venstre/Left/Links Bærearmlenke/Track control arm/Querlenker	(*)		
2	5012336 Højre/Right/Rechs Bærearmlenke/Track control arm/Querlenker	(*)		
3	5012337 Venstre/Left/Links Bærearmlenke/Track control arm/Querlenker	(**)		
4	5012338 Højre/Right/Rechs Bærearmlenke/Track control arm/Querlenker	(**)		
5	5032352 Venstre/Left/Links Styrekegle/Tie rod end/Kugelgelenk	14x1,5 RHT Yderste/Outer/Außen		
6	5032353 Højre/Right/Rechs Styrekegle/Tie rod end/Kugelgelenk	14x1,5 RHT Yderste/Outer/Außen		
7	5032362 V/H - L/R Styrekegle/Tie rod end/Axialgelenk	14x1,5 RHT Inderste/Inner		
8	5042315 V/H - L/R Bærekugle/Ball joint/Radgelenk	Nederste/Lower/Unten		
9	5092311 Manchetsæt/Boot kit/Manschetten satz			
10	5102303 For/Front/Vorne Bøsning/Bushing/Buchsen	V/H - L/R (**)		
11	5102304 Bag/Rear/Hinten Bøsning/Bushing/Buchsen	Venstre/Left/Links (*)		
POS				
12	5102305 Bag/Rear/Hinten Bøsning/Bushing/Buchsen	Højre/Right/Rechs (*)		
13	5102306 Bag/Rear/Hinten Bøsning/Bushing/Buchsen	Venstre/Left/Links (**)		
14	5102307 Bag/Rear/Hinten Bøsning/Bushing/Buchsen	Højre/Right/Rechs (**)		
15	5112308 V/H - L/R Stabilisator/Stabilizer/Stabilisator			
Bagaksel/Rear axle/Hinterachse				
16	5102318 V/H - L/R Bøsningssæt/Bushing set/Buchsen satz			
		(*)	Uden Servo Styring Without Power Steering Ohne Servolenkung	
		(**)	Med Servo Styring With Power Steering Mit Servolenkung	

POS	Panda 3/80- & Panda 750/1000 3/80-			
		Foraksel/Front axle/Vorneachse		
1	5012307 U V/H - L/R Bæream/Track control arm/Querlenker			 2
2	5022314 U 4/86 - Tandstang/Steering rack/Zahnstange			
3	5032318 V/H - L/R Styrekugle/Tie rod end/Kugelgelenk	12x1,5 RHT 11/82 - Yderste/Outer/Außen		 3
4	5042303 V/H - L/R Bærekugle/Ball joint/Radgelenk	Nederste/Lower/Unten		 4
5	5042313 V/H - L/R Bærekugle/Ball joint/Radgelenk	Nederste/Lower/Unten		 5
6	5042314 V/H - L/R Bærekugle komplet/Complete ball joint/Radgelenk komplett	Nederste/Lower/Unten		
7	5092301 Manchetsæt/Boot kit/Manschetten satz			 6
				 7
POS	Panda (169) 9/03-			
		Foraksel/Front axle/Vorneachse		
1	5012363 Venstre/Left/Links Bæream/Track control arm/Querlenker	Nederste/Lower/Unten		 3
2	5012364 Højre/Right/Rechs Bæream/Track control arm/Querlenker	Nederste/Lower/Unten		
3	5032369 Venstre/Left/Links Styrekugle/Tie rod end/Kugelgelenk	Yderste/Outer/Außen		 4
4	5032370 Højre/Right/Rechs Styrekugle/Tie rod end/Kugelgelenk	Yderste/Outer/Außen		
5	5032371 V/H - L/R Styrekugle/Tie rod end/Axialgelenk	Inderste/Inner		 5
6	5112313 V/H - L/R 318 mm. Stabilisatorstang/Stabilizer rod/Diagonalstrebe			 6

POS	Punto (176) 9/93-2/00		
Foraksel/Front axle/Vorneachse			
1	5012321 Venstre/Left/Links Bærearmlenke/Track control arm/Querlenker		
2	5012322 Højre/Right/Rechs Bærearmlenke/Track control arm/Querlenker		
3	5032344 V/H - L/R Styrekugle/Tie rod end/Kugelgelenk	12x1,5 RHT Yderste/Outer/Außen	
4	5032345 V/H - L/R (*) Styrekugle/Tie rod end/Axialgelenk	12x1,5 RHT Inderste/Inner	
5	5032346 V/H - L/R (**) Styrekugle/Tie rod end/Axialgelenk	12x1,5 RHT Inderste/Inner	
6	5092310 (*) Manchetsæt/Boot kit/Manschetten satz		
7	5092311 (**) Manchetsæt/Boot kit/Manschetten satz		
8	5102301 For/Front/Vorne Bøsning/Bushing/Buchsen	V/H - L/R	
9	5102308 Bag/Rear/Hinten Bøsning/Bushing/Buchsen	Venstre/Left/Links	
10	5102309 Bag/Rear/Hinten Bøsning/Bushing/Buchsen	Højre/Right/Rechs	
11	5112309 V/H - L/R 60 mm. Stabilisator/Stabilizer/Stabilisator		
Bagaksel/Rear axle/Hinterachse			
12	5012347 Venstre/Left/Links Bærearmlenke/Track control arm/Querlenker	(-ABS)	
13	5012348 Højre/Right/Rechs Bærearmlenke/Track control arm/Querlenker	(-ABS)	
14	5012349 Venstre/Left/Links Bærearmlenke/Track control arm/Querlenker	(ABS)	
15	5012350 Højre/Right/Rechs Bærearmlenke/Track control arm/Querlenker	(ABS)	
16	5102316 Bøsningssæt/Bushing set/Buchsen satz		

POS	Punto (188) 9/99-			
Foraksel/Front axle/Vorneachse				
1	5012353 Venstre/Left/Links Bæream/Track control arm/Querlenker			
2	5012354 Højre/Right/Rechs Bæream/Track control arm/Querlenker			
3	5032344 V/H - L/R Styrekugle/Tie rod end/Kugelgelenk	12x1,5 RHT Yderste/Outer/Außen		
4	5032363 V/H - L/R Styrekugle/Tie rod end/Axialgelenk	12x1,5 Inderste/Inner		
5	5092311 Manchetsæt/Boot kit/Manschetten satz			
6	5102321 For/Front/Vorne Bøsning/Bushing/Buchsen	V/H - L/R		
7	5102322 Bag/Rear/Hinten Bøsning/Bushing/Buchsen	V/H - L/R		
8	5112309 V/H - L/R 60 mm. Stabilisator/Stabilizer/Stabilisator			
POS	Grande Punto (199) 10/05-			
Foraksel/Front axle/Vorneachse				
1	5012365 Venstre/Left/Links Bæream/Track control arm/Querlenker	Nederste/Lower/Unten		
2	5012366 Højre/Right/Rechs Bæream/Track control arm/Querlenker	Nederste/Lower/Unten		
3	XXXXXXX V/H - L/R Styrekugle/Tie rod end/Axialgelenk	14x1,5 Inderste/Inner		
4	5032375 Venstre/Left/Links Styrekugle/Tie rod end/Kugelgelenk	14x1,5 RHT Yderste/Outer/Außen		
5	5032376 Højre/Right/Rechs Styrekugle/Tie rod end/Kugelgelenk	14x1,5 RHT Yderste/Outer/Außen		
6	5042321 V/H - L/R Bærekugle/Ball joint/Radgelenk	Nederste/Lower/Unten		
7	5112314 V/H - L/R 301 mm. Stabilisatorstang/Stabilizer rod/Diagonalstrebe			

POS	Regata 6/83-7/89 & Ritmo 6/83-7/89		
Foraksel/Front axle/Vorneachse			
1	5012303 V/H - L/R Bærearml/Track control arm/Querlenker		
2	5032303 V/H - L/R Styrekugle/Tie rod end/Kugelgelenk	12x1,5 RHT 6/83 - Yderste/Outer/Außen	
3	5092310 Manchetsæt/Boot kit/Manschetten satz		
POS Scudo 2/96- & Ulysse (220) 6/94-8/02			
Foraksel/Front axle/Vorneachse			
1	5011905 Venstre/Left/Links Bærearml/Track control arm/Querlenker	Støbejern/Cast iron/Grauguß	
2	5011906 Højre/Right/Rechs Bærearml/Track control arm/Querlenker	Støbejern/Cast iron/Grauguß	
3	5031916 V/H - L/R 14x1,5 RHT Styrekugle/Tie rod end/Kugelgelenk	Konus/Cone 15mm. Yderste/Outer/Außen	
4	5031917 V/H - L/R M14x1,5 RHT Styrekugle/Tie rod end/Axialgelenk	Inderste/Inner	
5	5093712 Manchetsæt/Boot kit/Manschetten satz		
6	5101907 For/Front/Vorne Bøsning/Bushing/Buchsen	V/H - L/R	
7	5101908 Bag/Rear/Hinten Bøsning/Bushing/Buchsen	Venstre/Left/Links	
8	5101909 Bag/Rear/Hinten Bøsning/Bushing/Buchsen	Højre/Right/Rechs	
9	5112302 V/H - L/R Ø12mm. 120 mm. Stabilisator/Stabilizer/Stabilisator		

POS	Seicento 1/98-			
Foraksel/Front axle/Vorneachse				
1	5012315 Venstre/Left/Links Bærearml/Track control arm/Querlenker			
2	5012316 Højre/Right/Rechs Bærearml/Track control arm/Querlenker			
3	5032303 V/H - L/R Styrekugle/Tie rod end/Kugelgelenk	12x1,5 RHT Yderste/Outer/Außen		
4	5032342 V/H - L/R Styrekugle/Tie rod end/Axialgelenk	12x1,5 RHT Inderste/Inner		
5	5092309 Manchetsæt/Boot kit/Manschetten satz			
6	5102301 For/Front/Vorne Bøsning/Bushing/Buchsen	V/H - L/R		
7	5102302 Bag/Rear/Hinten Bøsning/Bushing/Buchsen	V/H - L/R		
Foraksel/Front axle/Vorneachse				
1	5012335 Venstre/Left/Links (*) Bærearml/Track control arm/Querlenker			
2	5012336 Højre/Right/Rechs (*) Bærearml/Track control arm/Querlenker			
3	5012337 Venstre/Left/Links (**) Bærearml/Track control arm/Querlenker			
4	5012338 Højre/Right/Rechs (**) Bærearml/Track control arm/Querlenker			
5	5032352 Venstre/Left/Links Styrekugle/Tie rod end/Kugelgelenk	14x1,5 RHT Yderste/Outer/Außen		
6	5032353 Højre/Right/Rechs Styrekugle/Tie rod end/Kugelgelenk	14x1,5 RHT Yderste/Outer/Außen		
7	5032362 V/H - L/R Styrekugle/Tie rod end/Axialgelenk	14x1,5 RHT Inderste/Inner		
8	5042315 V/H - L/R Bærekugle/Ball joint/Radgelenk			
9	5092311 Manchetsæt/Boot kit/Manschetten satz			
10	5102303 For/Front/Vorne Bøsning/Bushing/Buchsen	V/H - L/R		

POS	Siena 9/98-			
Foraksel/Front axle/Vorneachse				
11	5102304 Bag/Rear/Hinten Bøsning/Bushing/Buchsen	Venstre/Left/Links (*)		
12	5102305 Bag/Rear/Hinten Bøsning/Bushing/Buchsen	Højre/Right/Rechs (*)		
13	5102306 Bag/Rear/Hinten Bøsning/Bushing/Buchsen	Venstre/Left/Links (**)		
14	5102307 Bag/Rear/Hinten Bøsning/Bushing/Buchsen	Højre/Right/Rechs (**)		
Bagaksel/Rear axle/Hinterachse				
15	5102318 V/H - L/R Bøsningssæt/Bushing set/Buchsen satz			
POS Stilo 10/01-				
Foraksel/Front axle/Vorneachse				
1	5012355 Venstre/Left/Links Bærear/Track control arm/Querlenker			
2	5012356 Højre/Right/Rechs Bærear/Track control arm/Querlenker			
3	5032364 V/H - L/R Styrekugle/Tie rod end/Kugelgelenk	14x1,5 Yderste/Outer/Außen		
4	5032365 V/H - L/R Styrekugle/Tie rod end/Axialgelenk	14x1,5 Inderste/Inner		
5	5102323 For/Front/Vorne Bøsning/Bushing/Buchsen	V/H - L/R		
6	5102324 Bag/Rear/Hinten Bøsning/Bushing/Buchsen	V/H - L/R		
7	5112310 V/H - L/R Stabilisator/Stabilizer/Stabilisator			
				(*) Uden Servo Styling Without Power Steering Ohne Servolenkung
				(**) Med Servo Styling With Power Steering Mit Servolenkung

POS	Strada 6/99-				
Foraksel/Front axle/Vorneachse					
1	5012351 Venstre/Left/Links Bærearml/Track control arm/Querlenker	- 8/01			
2	5012352 Højre/Right/Rechs Bærearml/Track control arm/Querlenker	- 8/01			
3	5012361 Venstre/Left/Links Bærearml/Track control arm/Querlenker	9/01 - Nederste/Lower/Unten			
4	5012362 Højre/Right/Rechs Bærearml/Track control arm/Querlenker	9/01 - Nederste/Lower/Unten			
5	5032352 Venstre/Left/Links Styrekgule/Tie rod end/Kugelgelenk	14x1,5 RHT			
6	5032353 Højre/Right/Rechs Styrekgule/Tie rod end/Kugelgelenk	14x1,5 RHT			
7	5042319 V/H - L/R - 8/01 Bærekugle/Ball joint/Radgelenk	Nederste/Lower/Unten			
8	5042320 V/H - L/R 9/01 - Bærekugle/Ball joint/Radgelenk	Nederste/Lower/Unten			
9	5092311 Manchetsæt/Boot kit/Manschetten satz				
10	5102303 For/Front/Vorne Bøsning/Bushing/Buchsen	V/H - L/R			
11	5102319 Bag/Rear/Hinten Bøsning/Bushing/Buchsen	Venstre/Left/Links			
POS					
12	5102320 Bag/Rear/Hinten Bøsning/Bushing/Buchsen	Højre/Right/Rechs			

POS	Talento 5/88-3/94		
Foraksel/Front axle/Vorneachse			
1	5011925 Venstre/Left/Links Bærearml/Track control arm/Querlenker	(1.8 Ton)	
2	5011926 Højre/Right/Rechs Bærearml/Track control arm/Querlenker	(1.8 Ton)	
3	5011927 Venstre/Left/Links Bærearml/Track control arm/Querlenker	(1.0 - 1.4 Ton)	
4	5011928 Højre/Right/Rechs Bærearml/Track control arm/Querlenker	(1.0 - 1.4 Ton)	
5	5032328 V/H - L/R Styrekugle/Tie rod end/Kugelgelenk	16x1,5 RHT Yderste/Outer/Außen	
6	5032338 V/H - L/R Styrekugle/Tie rod end/Axialgelenk	16x1,5 RHT Inderste/Inner	
7	5042309 V/H - L/R Bærekugle/Ball joint/Radgelenk	Nederste/Lower/Unten	
8	5091910 Manchetsæt/Boot kit/Manschetten satz		
9	5113709 V/H - L/R Ø14mm. 135 mm. Stabilisator bolt/Stabilizer bolt/Stabilisator bolzen		
POS Tempra 2/90-8/96			
Foraksel/Front axle/Vorneachse			
1	5012317 Venstre/Left/Links Bærearml/Track control arm/Querlenker	Konus/Cone 15mm.	
2	5012318 Højre/Right/Rechs Bærearml/Track control arm/Querlenker	Konus/Cone 15mm.	
3	5012319 Venstre/Left/Links Bærearml/Track control arm/Querlenker	Konus/Cone 17mm. 7/90 -	
4	5012320 Højre/Right/Rechs Bærearml/Track control arm/Querlenker	Konus/Cone 17mm. 7/90 -	
5	5032333 Venstre/Left/Links Styrekugle/Tie rod end/Kugelgelenk	12x1,5 RHT Yderste/Outer/Außen	
6	5032334 Højre/Right/Rechs Styrekugle/Tie rod end/Kugelgelenk	12x1,5 RHT Yderste/Outer/Außen	
7	5032343 V/H - L/R (**) Styrekugle/Tie rod end/Axialgelenk	12x1,5 RHT Inderste/Inner	
8	5092308 (*) Manchetsæt/Boot kit/Manschetten satz		
9	5092310 (**) Manchetsæt/Boot kit/Manschetten satz		
10	5101001 Bag/Rear/Hinten Bøsning/Bushing/Buchsen	Venstre/Left/Links	
		(*)	Uden Servo Styling Without Power Steering Ohne Servolenkung
		(**)	Med Servo Styling With Power Steering Mit Servolenkung









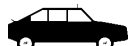

POS	Tempra 2/90-8/96					
		Foraksel/Front axle/Vorneachse				
11	5101002	Bag/Rear/Hinten Bøsning/Bushing/Buchsen	Højre/Right/Rechs			
12	5101003	For/Front/Vorne Bøsning/Bushing/Buchsen	V/H - L/R	11	12	
13	5112301	V/H - L/R Ø12mm. 100 mm. Stabilisator/Stabilizer/Stabilisator				
		Bagaksel/Rear axle/Hinterachse				
14	5102317	Bøsningssæt/Bushing set/Buchsen satz		13	14	
		Foraksel/Front axle/Vorneachse				
POS	Tipo 11/87-8/96					
		Foraksel/Front axle/Vorneachse				
1	5012317	Venstre/Left/Links Bærearmlenke/Track control arm/Querlenker	Konus/Cone 15mm. - 6/90			
2	5012318	Højre/Right/Rechs Bærearmlenke/Track control arm/Querlenker	Konus/Cone 15mm. - 6/90	1	2	
3	5012319	Venstre/Left/Links Bærearmlenke/Track control arm/Querlenker	Konus/Cone 17mm. 7/90 -			
4	5012320	Højre/Right/Rechs Bærearmlenke/Track control arm/Querlenker	Konus/Cone 17mm. 7/90 -	3	4	
5	5032333	Venstre/Left/Links Styrekugle/Tie rod end/Kugelgelenk	12x1,5 RHT Yderste/Outer/Außen			
6	5032334	Højre/Right/Rechs Styrekugle/Tie rod end/Kugelgelenk	12x1,5 RHT Yderste/Outer/Außen	5	6	
7	5032343	V/H - L/R (**) Styrekugle/Tie rod end/Axialgelenk	12x1,5 RHT Inderste/Inner			
8	5092308	(*) Manchetsæt/Boot kit/Manschetten satz		7	8	
9	5092310	(**) Manchetsæt/Boot kit/Manschetten satz			9	
10	5101001	Bag/Rear/Hinten Bøsning/Bushing/Buchsen	Venstre/Left/Links		10	
				(*)	Uden Servo Styling Without Power Steering Ohne Servolenkung	
				(**)	Med Servo Styling With Power Steering Mit Servolenkung	

POS	Tipo 11/87-8/96				
Foraksel/Front axle/Vorneachse					
11	5101002 Bag/Rear/Hinten Bøsning/Bushing/Buchsen	Højre/Right/Rechs			
12	5101003 For/Front/Vorne Bøsning/Bushing/Buchsen	V/H - L/R			
13	5112301 V/H - L/R Ø12mm. 100 mm. Stabilisator/Stabilizer/Stabilisator				
Bagaksel/Rear axle/Hinterachse					
14	5102317 Bøsningssæt/Bushing set/Buchsen satz				
POS Ulysse (220) 6/94-8/02					
Foraksel/Front axle/Vorneachse					
1	5011905 Venstre/Left/Links Bærearmlenke/Track control arm/Querlenker	Støbejern/Cast iron/Grauguß			
2	5011906 Højre/Right/Rechs Bærearmlenke/Track control arm/Querlenker	Støbejern/Cast iron/Grauguß			
3	5031916 V/H - L/R 14x1,5 RHT Styrekugle/Tie rod end/Kugelgelenk	Konus/Cone 15mm. Yderste/Outer/Außen			
4	5031917 V/H - L/R Styrekugle/Tie rod end/Axialgelenk	M14x1,5 RHT Inderste/Inner			
5	5092314 Manchetsæt/Boot kit/Manschetten satz				
6	5112302 V/H - L/R Ø12mm. 120 mm. Stabilisator/Stabilizer/Stabilisator				









POS	Ulysse (179AX) 8/02-		
Foraksel/Front axle/Vorneachse			
1	5011939 Venstre/Left/Links Bærearml/Track control arm/Querlenker		
2	5011940 Højre/Right/Rechs Bærearml/Track control arm/Querlenker		
3	XXXXXXX V/H - L/R Styrekugle/Tie rod end/Axialgelenk	Inderste/Inner	
4	XXXXXXX V/H - L/R 14x1,5 Styrekugle/Tie rod end/Kugelgelenk	Konus/Cone 13,5mm. Yderste/Outer/Außen	
5	XXXXXXX V/H - L/R 262,5 mm. Stabilisatorstang/Stabilizer rod/Diagonalstrebe		
POS	Uno 1/83-		
Foraksel/Front axle/Vorneachse			
1	5012311 Venstre/Left/Links Bærearml/Track control arm/Querlenker		
2	5012312 Højre/Right/Rechs Bærearml/Track control arm/Querlenker		
3	5022307 U (- Turbo, Turbo Diesel & Diesel) Tandstang/Steering rack/Zahnstange		
4	5032308 V/H - L/R Styrekugle/Tie rod end/Kugelgelenk	12x1,5 RHT Yderste/Outer/Außen	
5	5032347 V/H - L/R (-Turbo diesel) Styrekugle/Tie rod end/Axialgelenk	12x1,5 RHT Inderste/Inner	
6	5042303 V/H - L/R Bærekugle/Ball joint/Radgelenk	Nederste/Lower/Unten	
7	5042313 V/H - L/R Bærekugle/Ball joint/Radgelenk	Nederste/Lower/Unten	
8	5092301 Manchetsæt/Boot kit/Manschetten satz		
9	5102301 For/Front/Vorne Bøsning/Bushing/Buchsen	V/H - L/R	
10	5102302 Bag/Rear/Hinten Bøsning/Bushing/Buchsen	V/H - L/R	















FIAT



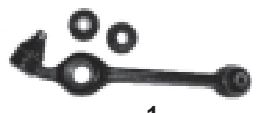





POS	
POS	



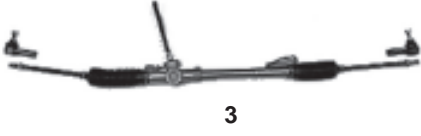



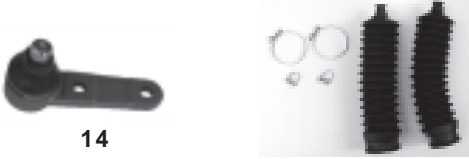
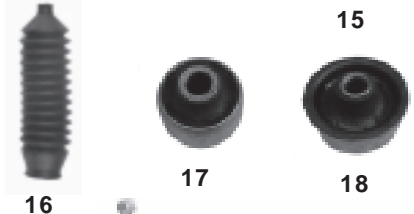

POS	Capri MK I / MK II / MK III 12/68-4/87		
Foraksel/Front axle/Vorneachse			
1	5012501 U Venstre/Left/Links Bæream/Track control arm/Querlenker		
2	5092503 Manchetsæt/Boot kit/Manschetten satz		
			1 2
POS	Cortina MK III 1970-76		
Foraksel/Front axle/Vorneachse			
1	5022506 Tandstang/Steering rack/Zahnstange		
2	5032503 V/H - L/R Styrekugle/Tie rod end/Kugelgelenk	14x2 RHT Yderste/Outer/Außen	
3	5042506 V/H - L/R Bærekugle/Ball joint/Radgelenk	Nederste/Lower/Unten	
4	5042507 V/H - L/R Bærekugle/Ball joint/Radgelenk	Øverste/Upper/Oben	
5	5092510 Manchetsæt/Boot kit/Manschetten satz		
6	5112501 V/H - L/R 190 mm. Stabilisator bolt/Stabilizer bolt/Stabilisator bolzen		
Bagaksel/Rear axle/Hinterachse			
7	5102501 Bag/Rear/Hinten Bøsning/Bushing/Buchsen	V/H - L/R	
8	5102502 V/H - L/R Bøsning/Bushing/Buchsen	Øverste/Upper/Oben	
9	5102503 For/Front/Vorne Bøsning/Bushing/Buchsen	V/H - L/R	
10	5102504 V/H - L/R Bøsning/Bushing/Buchsen	Nederste/Lower/Unten	
			5 6 7 8 9 10

POS	Cougar 8/98-			
Foraksel/Front axle/Vorneachse				
1	XXXXXXX Venstre/Left/Links Bærearmlenke/Track control arm/Querlenker			
2	XXXXXXX Højre/Right/Rechs Bærearmlenke/Track control arm/Querlenker			
3	5032545 Venstre/Left/Links Styrekugle/Tie rod end/Kugelgelenk	16x1,5 RHT Yderste/Outer/Außen		
4	5032546 Højre/Right/Rechs Styrekugle/Tie rod end/Kugelgelenk	16x1,5 RHT Yderste/Outer/Außen		
5	5032547 V/H - L/R Styrekugle/Tie rod end/Axialgelenk	16x1,5 RHT Inderste/Inner		
6	5042517 V/H - L/R Bærekugle/Ball joint/Radgelenk		Nederste/Lower/Unten	
7	5092518 Manchetsæt/Boot kit/Manschetten satz			
8	XXXXXXX For/Front/Vorne Bøsning/Bushing/Buchsen		V/H - L/R	
9	XXXXXXX Bag/Rear/Hinten Bøsning/Bushing/Buchsen		V/H - L/R	
10	5112503 V/H - L/R 240 mm. Stabilisatorstang/Stabilizer rod/Diagonalstrebe			
Foraksel/Front axle/Vorneachse				
1	5033225 V/H - L/R Styrekugle/Tie rod end/Axialgelenk	14x1,5 RHT Inderste/Inner		
2	5042513 U V/H - L/R Bærekugle/Ball joint/Radgelenk		Nederste/Lower/Unten	
3	5043213 V/H - L/R Bærekugle/Ball joint/Radgelenk		Øverste/Upper/Oben	

POS	 Escort MK. I 9/68-3/75		
		Foraksel/Front axle/Vorneachse	
1	5012501 U Venstre/Left/Links Bæream/Track control arm/Querlenker		
2	5032501 V/H - L/R Styrekugle/Tie rod end/Kugelgelenk	1/2x20 UNF RHT Yderste/Outer/Außen	
3	5092503 Manchetsæt/Boot kit/Manschetten satz		
			<div style="display: flex; justify-content: space-around;"> 1 2 3 </div>
POS	 Escort MK. II 12/74-8/80		
		Foraksel/Front axle/Vorneachse	
1	5012501 U Venstre/Left/Links Bæream/Track control arm/Querlenker		
2	5032503 V/H - L/R Styrekugle/Tie rod end/Kugelgelenk	14x2 RHT Yderste/Outer/Außen	
3	5092503 Manchetsæt/Boot kit/Manschetten satz		
			<div style="display: flex; justify-content: space-around;"> 1 2 3 </div>

POS	Escort MK. III 9/80-12/85 & Orion I 9/83-12/85
Foraksel/Front axle/Vorneachse	
1	5012503 Venstre/Left/Links Bæream/Track control arm/Querlenker 6/83 - 
2	5012504 Højre/Right/Rechs Bæream/Track control arm/Querlenker 6/83 - 
3	5022505 U Tandstang/Steering rack/Zahnstange 
4	5032501 V/H - L/R Styrekugle/Tie rod end/Kugelgelenk 1/2x20 UNF RHT Yderste/Outer/Außen 
5	5032522 V/H - L/R Styrekugle/Tie rod end/Axialgelenk 1/2x20 UNF RHT Inderste/Inner 
6	5042503 U V/H - L/R - 5/83 Bærekugle/Ball joint/Radgelenk Nederste/Lower/Unten 
7	5092501 - 5/83 Manchetsæt/Boot kit/Manschetten satz 
8	5092514 6/83 - Manchetsæt/Boot kit/Manschetten satz 
9	5102506 V/H - L/R 6/83 - Bøsning/Bushing/Buchsen Yderste/Outer/Außen 
POS Escort IV 1/86-9/90 & Orion II 2/86-9/90	
Foraksel/Front axle/Vorneachse	
1	5012509 Venstre/Left/Links Bæream/Track control arm/Querlenker 
2	5012510 Højre/Right/Rechs Bæream/Track control arm/Querlenker 
3	5022505 U Tandstang/Steering rack/Zahnstange 
4	5032501 V/H - L/R Styrekugle/Tie rod end/Kugelgelenk 1/2x20 UNF RHT Yderste/Outer/Außen 
5	5032522 V/H - L/R Styrekugle/Tie rod end/Axialgelenk 1/2x20 UNF RHT Inderste/Inner 
6	5092514 Manchetsæt/Boot kit/Manschetten satz 
7	5102506 V/H - L/R Bøsning/Bushing/Buchsen Yderste/Outer/Außen 

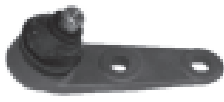







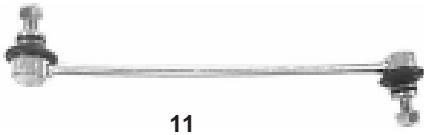

POS	 Escort V-VII 10/90-7/00 & Orion III 10/90-9/94			
Foraksel/Front axle/Vorneachse				
1	5012523 Venstre/Left/Links Bærearml/Track control arm/Querlenker	(- Cosworth)		
2	5012524 Højre/Right/Rechs Bærearml/Track control arm/Querlenker	(- Cosworth)		
3	5022514 (*) Tandstang/Steering rack/Zahnstange			
4	5032504 Venstre/Left/Links Styrekugle/Tie rod end/Kugelgelenk	14x2 RHT (Cosworth) Yderste/Outer/Außen		
5	5032505 Højre/Right/Rechs Styrekugle/Tie rod end/Kugelgelenk	14x2 RHT (Cosworth) Yderste/Outer/Außen		
6	5032523 Venstre/Left/Links Styrekugle/Tie rod end/Kugelgelenk	14x2 RHT Yderste/Outer/Außen		
7	5032523 Venstre/Left/Links Styrekugle/Tie rod end/Kugelgelenk	14x2 RHT (- Cosworth) Yderste/Outer/Außen		
8	5032524 Højre/Right/Rechs Styrekugle/Tie rod end/Kugelgelenk	14x2 RHT Yderste/Outer/Außen		
9	5032524 Højre/Right/Rechs Styrekugle/Tie rod end/Kugelgelenk	14x2 RHT (- Cosworth) Yderste/Outer/Außen		
POS				
10	5032525 V/H - L/R (*) Styrekugle/Tie rod end/Axialgelenk	14x2 RHT Inderste/Inner		
11	5032525 V/H - L/R (- Cosworth) (*) Styrekugle/Tie rod end/Axialgelenk	14x2 RHT Inderste/Inner		
12	5032552 V/H - L/R (**) Styrekugle/Tie rod end/Axialgelenk	14 x 2 Inderste/Inner		
13	5032552 V/H - L/R (- Cosworth) (**) Styrekugle/Tie rod end/Axialgelenk	14 x 2 Inderste/Inner		
14	5042514 V/H - L/R Bærekugle/Ball joint/Radgelenk	Nederste/Lower/Unten		
15	5092515 (**) Manchetsæt/Boot kit/Manschetten satz			
16	5092519 (*) Manchetsæt/Boot kit/Manschetten satz			
17	5102510 For/Front/Vorne Bøsning/Bushing/Buchsen	V/H - L/R		
18	5102511 Bag/Rear/Hinten Bøsning/Bushing/Buchsen	V/H - L/R		
19	5112503 V/H - L/R 240 mm. Stabilisatorstang/Stabilizer rod/Diagonalstrebe			
			(*)	Uden Servo Styling Without Power Steering Ohne Servolenkung
			(**)	Med Servo Styling With Power Steering Mit Servolenkung

POS	Fiesta I 5/76-8/83		
Foraksel/Front axle/Vorneachse			
1	5032501 V/H - L/R 1/2x20 UNF RHT Styrekugle/Tie rod end/Kugelgelenk	Yderste/Outer/Außen	
2	5042501 V/H - L/R Bærekugle/Ball joint/Radgelenk	Nederste/Lower/Unten	
3	5092501 Manchetsæt/Boot kit/Manschetten satz		
POS Fiesta II 8/83-4/89			
Foraksel/Front axle/Vorneachse			
1	5012511 U Venstre/Left/Links Bæream/Track control arm/Querlenker		
2	5012512 U Højre/Right/Rechs Bæream/Track control arm/Querlenker		
3	5032501 V/H - L/R 1/2x20 UNF RHT Styrekugle/Tie rod end/Kugelgelenk	Yderste/Outer/Außen	
4	5032516 V/H - L/R LHT Styrekugle/Tie rod end/Axialgelenk	Inderste/Inner	
5	5042502 V/H - L/R Bærekugle/Ball joint/Radgelenk	Nederste/Lower/Unten	
6	5092501 Manchetsæt/Boot kit/Manschetten satz		

POS	Fiesta 5/89-12/91		
Foraksel/Front axle/Vorneachse			
1	5012513 Venstre/Left/Links Bæream/Track control arm/Querlenker		
2	5012514 Højre/Right/Rechs Bæream/Track control arm/Querlenker		
3	5022513 Tandstang/Steering rack/Zahnstange		
4	5032501 V/H - L/R 1/2x20 UNF RHT Styrekugle/Tie rod end/Kugelgelenk	Yderste/Outer/Außen	
5	5032518 V/H - L/R 1/2x20 UNF RHT Styrekugle/Tie rod end/Axialgelenk	Inderste/Inner	
6	5042514 V/H - L/R Bærekugle/Ball joint/Radgelenk	Nederste/Lower/Unten	
7	5092517 Manchetsæt/Boot kit/Manschetten satz		
8	5102510 For/Front/Vorne Bøsning/Bushing/Buchsen	V/H - L/R	
9	5102511 Bag/Rear/Hinten Bøsning/Bushing/Buchsen	V/H - L/R	
10	5112503 V/H - L/R 240 mm. Stabilisatorstang/Stabilizer rod/Diagonalstrebe		
Foraksel/Front axle/Vorneachse			
1	5012515 Venstre/Left/Links Bæream/Track control arm/Querlenker	(- 16V)	
2	5012516 Højre/Right/Rechs Bæream/Track control arm/Querlenker	(- 16V)	
3	5012517 Venstre/Left/Links Bæream/Track control arm/Querlenker	16V	
4	5012518 Højre/Right/Rechs Bæream/Track control arm/Querlenker	16V	
5	5022513 Tandstang/Steering rack/Zahnstange		
6	5032501 V/H - L/R Styrekugle/Tie rod end/Kugelgelenk	1/2x20 UNF RHT Yderste/Outer/Außen	
7	5032518 V/H - L/R Styrekugle/Tie rod end/Axialgelenk	1/2x20 UNF RHT Inderste/Inner	
8	5042514 V/H - L/R (-16V) Bærekugle/Ball joint/Radgelenk	Nederste/Lower/Unten	
9	5092516 Manchetsæt/Boot kit/Manschetten satz		
10	5102510 For/Front/Vorne Bøsning/Bushing/Buchsen	V/H - L/R	
11	5102511 Bag/Rear/Hinten Bøsning/Bushing/Buchsen	V/H - L/R	
12	5112503 V/H - L/R 240 mm. Stabilisatorstang/Stabilizer rod/Diagonalstrebe		

POS	Fiesta 1/94-12/95				
Foraksel/Front axle/Vorneachse					
1	5012519 Venstre/Left/Links Bærearml/Track control arm/Querlenker	(*)			
2	5012520 Højre/Right/Rechs Bærearml/Track control arm/Querlenker	(*)			
3	5012521 Venstre/Left/Links Bærearml/Track control arm/Querlenker	(**)			
4	5012522 Højre/Right/Rechs Bærearml/Track control arm/Querlenker	(**)			
5	5022513 Tandstang/Steering rack/Zahnstange				
6	5032518 V/H - L/R Styrekugle/Tie rod end/Axialgelenk	1/2x20 UNF RHT Inderste/Inner			
7	5032531 V/H - L/R Styrekugle/Tie rod end/Kugelgelenk	1/2x20 UNF RHT Yderste/Outer/Außen			
8	5042516 V/H - L/R Bærekugle/Ball joint/Radgelenk	Nederste/Lower/Unten			
9	5092516 Manchetsæt/Boot kit/Manschetten satz				
10	5102510 For/Front/Vorne Bøsning/Bushing/Buchsen	V/H - L/R			
11	5102511 Bag/Rear/Hinten Bøsning/Bushing/Buchsen	V/H - L/R			
12	5112503 V/H - L/R 240 mm. Stabilisatorstang/Stabilizer rod/Diagonalstrebe				
POS	Fiesta 1/96-5/98 & Fiesta Courier 2/96-5/98				
Foraksel/Front axle/Vorneachse					
1	5012527 Venstre/Left/Links Bærearml/Track control arm/Querlenker	(- Courier) (*)			
2	5012528 Højre/Right/Rechs Bærearml/Track control arm/Querlenker	(- Courier) (*)			
3	5012529 Venstre/Left/Links Bærearml/Track control arm/Querlenker	(**)			
4	5012530 Højre/Right/Rechs Bærearml/Track control arm/Querlenker	(**)			
5	5032526 Venstre/Left/Links Styrekugle/Tie rod end/Kugelgelenk	12x1,5 RHT Yderste/Outer/Außen			
6	5032527 Højre/Right/Rechs Styrekugle/Tie rod end/Kugelgelenk	12x1,5 RHT Yderste/Outer/Außen			
7	5032534 V/H - L/R 12x1,5 RHT Styrekugle/Tie rod end/Axialgelenk	Konus/Cone 11,5mm. Inderste/Inner			
8	5042516 V/H - L/R Bærekugle/Ball joint/Radgelenk	Nederste/Lower/Unten			
9	5092519 (*) Manchetsæt/Boot kit/Manschetten satz				
		(*)	Uden Servo Styring Without Power Steering Ohne Servolenkung		
		(**)	Med Servo Styring With Power Steering Mit Servolenkung		







POS	Fiesta 1/96-5/98 & Fiesta Courier 2/96-5/98				
Foraksel/Front axle/Vorneachse					
10	5092522 (**) Manchetsæt/Boot kit/Manschetten satz				
11	5102512 For/Front/Vorne Bøsning/Bushing/Buchsen	V/H - L/R			
12	5102513 Bag/Rear/Hinten Bøsning/Bushing/Buchsen	V/H - L/R			
13	5112503 V/H - L/R 240 mm. Stabilisatorstang/Stabilizer rod/Diagonalstrebe				
POS	Fiesta 5/98- & Fiesta Courier 5/98-				
Foraksel/Front axle/Vorneachse					
1	5012539 Venstre/Left/Links Bærearmlenke/Track control arm/Querlenker	(**)			
2	5012540 Højre/Right/Rechts Bærearmlenke/Track control arm/Querlenker	(**)			
3	5032526 Venstre/Left/Links Styrekugle/Tie rod end/Kugelgelenk	12x1,5 RHT Yderste/Outer/Außen			
4	5032527 Højre/Right/Rechts Styrekugle/Tie rod end/Kugelgelenk	12x1,5 RHT Yderste/Outer/Außen			
5	5032534 V/H - L/R 12x1,5 RHT Styrekugle/Tie rod end/Axialgelenk	Konus/Cone 11,5mm. Inderste/Inner			
6	5042516 V/H - L/R Bærekugle/Ball joint/Radgelenk	Nederste/Lower/Unten			
7	5092519 (*) Manchetsæt/Boot kit/Manschetten satz				
8	5092522 (**) Manchetsæt/Boot kit/Manschetten satz				
9	5102512 For/Front/Vorne Bøsning/Bushing/Buchsen	V/H - L/R			(*) Uden Servo Styling Without Power Steering Ohne Servolenkung
10	5102513 Bag/Rear/Hinten Bøsning/Bushing/Buchsen	V/H - L/R			(**) Med Servo Styling With Power Steering Mit Servolenkung

POS	Fiesta 5/98- & Fiesta Courier 5/98-		
		Foraksel/Front axle/Vorneachse	
11	5112503 V/H - L/R 240 mm. Stabilisatorstang/Stabilizer rod/Diagonalstrebe	 11	
POS	Fiesta 11/01-		
		Foraksel/Front axle/Vorneachse	
1	5012541 Venstre/Left/Links Bæream/Track control arm/Querlenker	 1	
2	5012542 Højre/Right/Rechs Bæream/Track control arm/Querlenker	 2	
3	5032555 Venstre/Left/Links Styrekugle/Tie rod end/Kugelgelenk	14x1,5 RHT Yderste/Outer/Außen	 3
4	5032556 Højre/Right/Rechs Styrekugle/Tie rod end/Kugelgelenk	14x1,5 RHT Yderste/Outer/Außen	 4
5	5032566 V/H - L/R 278 mm. Styrekugle/Tie rod end/Kugelgelenk	14x1,5 Inderste/Inner	
6	5042522 V/H - L/R Bærekugle/Ball joint/Radgelenk	Nederste/Lower/Unten	
7	5102523 For/Front/Vorne Bøsning/Bushing/Buchsen	V/H - L/R	 7
8	5102524 Bag/Rear/Hinten Bøsning/Bushing/Buchsen	V/H - L/R	 8
9	5112520 V/H - L/R 240 mm. Stabilisatorstang/Stabilizer rod/Diagonalstrebe	 9	





POS	Focus 10/98-			
Foraksel/Front axle/Vorneachse				
1	5012531 Venstre/Left/Links Bærearmlenker/Track control arm/Querlenker			
2	5012532 Højre/Right/Rechts Bærearmlenker/Track control arm/Querlenker			
3	5032538 Venstre/Left/Links Styrekugle/Tie rod end/Kugelgelenk	14x2 Yderste/Outer/Außen		
4	5032539 Højre/Right/Rechts Styrekugle/Tie rod end/Kugelgelenk	14x2 Yderste/Outer/Außen		
5	5032553 V/H - L/R Styrekugle/Tie rod end/Axialgelenk	14x2 RHT Inderste/Inner		
6	5042520 V/H - L/R Bærekugle/Ball joint/Radgelenk	Konus/Cone 17,5mm. Nederste/Lower/Unten		
7	5092523 Manchetsæt/Boot kit/Manschetten satz			
8	5102518 For/Front/Vorne Bøsning/Bushing/Buchsen	V/H - L/R		
9	5102519 Bag/Rear/Hinten Bøsning/Bushing/Buchsen	V/H - L/R		
10	5112503 V/H - L/R 240 mm. Stabilisatorstang/Stabilizer rod/Diagonalstrebe			
Bagaksel/Rear axle/Hinterachse				
11	5012551 V/H - L/R Bærearmlenker/Track control arm/Querlenker	Øverste/Upper/Oben		
12	5012552 V/H - L/R Bærearmlenker/Track control arm/Querlenker	Nederste/Lower/Unten		
13	5112509 V/H - L/R 103 mm. Stabilisator bolt/Stabilizer bolt/Stabilisator bolzen			

POS	Focus II & Focus C-Max 10/03-			
Foraksel/Front axle/Vorneachse				
1	XXXXXXX	Venstre/Left/Links	Bæream/Track control arm/Querlenker	Nederste/Lower/Unten
2	XXXXXXX	Højre/Right/Rechs	Bæream/Track control arm/Querlenker	Nederste/Lower/Unten
3	5032562	V/H - L/R	Styrekugle/Tie rod end/Axialgelenk	Inderste/Inner
4	5032567	Venstre/Left/Links	Styrekugle/Tie rod end/Kugelgelenk	Yderste/Outer/Außen
5	5032568	Højre/Right/Rechs	Styrekugle/Tie rod end/Kugelgelenk	Yderste/Outer/Außen
6	5042525	V/H - L/R	Bærekugle/Ball joint/Radgelenk	Konus/Cone 18mm. Nederste/Lower/Unten
7	5114809	V/H - L/R	300 mm. Stabilisatorstang/Stabilizer rod/Diagonalstrebe	
Bagaksel/Rear axle/Hinterachse				
8	5112522	V/H - L/R (C-Max)	99 mm. Stabilisator bolt/Stabilizer bolt/Stabilisator bolzen	
9	XXXXXXX	V/H - L/R (- C-Max)	Stabilisator/Stabilizer/Stabilisator	
POS	Fusion 8/02-			
Foraksel/Front axle/Vorneachse				
1	5032566	V/H - L/R	278 mm.	14x1,5 Inderste/Inner
2	5112520	V/H - L/R	240 mm. Stabilisatorstang/Stabilizer rod/Diagonalstrebe	



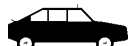















POS	Galaxy 11/95-		
Foraksel/Front axle/Vorneachse			
1	5002503 Venstre/Left/Links Styrestang/Steering rod/Spurstange		
2	5002504 Højre/Right/Rechs Styrestang/Steering rod/Spurstange		
3	5012533 Venstre/Left/Links Bæream/Track control arm/Querlenker		
4	5012534 Højre/Right/Rechs Bæream/Track control arm/Querlenker		
5	5032541 Venstre/Left/Links Styrekugle/Tie rod end/Kugelgelenk	14x1,5 RHT Yderste/Outer/Außen	
6	5032542 Højre/Right/Rechs Styrekugle/Tie rod end/Kugelgelenk	14x1,5 RHT Yderste/Outer/Außen	
7	5032543 V/H - L/R Styrekugle/Tie rod end/Axialgelenk	14x1,5 RHT Inderste/Inner	
8	5044733 V/H - L/R Bærekugle/Ball joint/Radgelenk		
9	5092316 Manchetsæt/Boot kit/Manschetten satz		
10	5102514 Bag/Rear/Hinten Bøsning/Bushing/Buchsen	V/H - L/R	
11	5102515 For/Front/Vorne Bøsning/Bushing/Buchsen	V/H - L/R	
POS			
12	5112303 V/H - L/R 205 mm. Stabilisatorstang/Stabilizer rod/Diagonalstrebe		
Bagaksel/Rear axle/Hinterachse			
13	5102515 For/Front/Vorne Bøsning/Bushing/Buchsen	V/H - L/R	

POS	 Galaxy 5/06-			
Foraksel/Front axle/Vorneachse				
1	Venstre/Left/Links Styrekugle/Tie rod end/Kugelgelenk			
2	Højre/Right/Rechs Styrekugle/Tie rod end/Kugelgelenk			
POS	 Consul 3/72-8/85 & Granada 3/72-8/85			
Foraksel/Front axle/Vorneachse				
1	5032503 V/H - L/R Styrekugle/Tie rod end/Kugelgelenk	14x2 RHT Yderste/Outer/Außen		
2	5042508 V/H - L/R Bærekugle/Ball joint/Radgelenk	Øverste/Upper/Oben	1	2
3	5042509 V/H - L/R Bærekugle/Ball joint/Radgelenk	Nederste/Lower/Unten		
4	5092512 (*) Manchetsæt/Boot kit/Manschetten satz		3	4
5	5112502 V/H - L/R 160 mm. Stabilisator bolt/Stabilizer bolt/Stabilisator bolzen			
			5	
				(*) Uden Servo Styring Without Power Steering Ohne Servolenkung

POS	Ka 9/96-				
Foraksel/Front axle/Vorneachse					
1	5012521	Venstre/Left/Links Bærearml/Track control arm/Querlenker	- 12/97 (*)		
2	5012522	Højre/Right/Rechs Bærearml/Track control arm/Querlenker	- 12/97 (*)		
3	5012543	Venstre/Left/Links Bærearml/Track control arm/Querlenker	1/98 - (*)		
4	5012544	Højre/Right/Rechs Bærearml/Track control arm/Querlenker	1/98 - (*)		
5	5012545	Venstre/Left/Links Bærearml/Track control arm/Querlenker	1/98 - (**)		
6	5012546	Højre/Right/Rechs Bærearml/Track control arm/Querlenker	1/98 - (**)		
7	5032531	V/H - L/R Styrekugle/Tie rod end/Kugelgelenk	1/2x20 UNF RHT Yderste/Outer/Außen		
8	5032537	V/H - L/R Styrekugle/Tie rod end/Axialgelenk	14x1,5 RHT Inderste/Inner		
9	5042516	V/H - L/R Bærekugle/Ball joint/Radgelenk	Nederste/Lower/Unten		
10	5092519	(*) Manchetsæt/Boot kit/Manschetten satz			
11	5092522	(**) Manchetsæt/Boot kit/Manschetten satz			
POS					
12	5102510	For/Front/Vorne Bøsning/Bushing/Buchsen	V/H - L/R		
13	5102511	Bag/Rear/Hinten Bøsning/Bushing/Buchsen	V/H - L/R		
14	5112503	V/H - L/R 240 mm. Stabilisatorstang/Stabilizer rod/Diagonalstrebe			
					(*) Uden Servo Styring Without Power Steering Ohne Servolenkung
					(**) Med Servo Styring With Power Steering Mit Servolenkung

POS	 Street Ka 5/03-
POS	 Maverick 2/93-4/98
Foraksel/Front axle/Vorneachse	
1	5032247 V/H - L/R 6/96 - Styrekugle/Tie rod end/Kugelgelenk 16x1,5 Yderste/Outer/Außen
2	5032248 V/H - L/R 6/96 - Styrekugle/Tie rod end/Kugelgelenk 16x1,5 Inderste/Inner
3	5042210 V/H - L/R Bærekugle/Ball joint/Radgelenk Øverste/Upper/Oben
4	5042220 V/H - L/R Bærekugle/Ball joint/Radgelenk Nederste/Lower/Unten
	   



POS	Mondeo I & Mondeo Turnier I 2/93-8/96			
Foraksel/Front axle/Vorneachse				
1	5012525 Venstre/Left/Links Bærearmlenke/Track control arm/Querlenker			
2	5012526 Højre/Right/Rechts Bærearmlenke/Track control arm/Querlenker			
3	5032528 Venstre/Left/Links Styrekugle/Tie rod end/Kugelgelenk	16x1,5 RHT Yderste/Outer/Außen		
4	5032529 Højre/Right/Rechts Styrekugle/Tie rod end/Kugelgelenk	16x1,5 RHT Yderste/Outer/Außen		
5	5032530 V/H - L/R 14" Hjul/Wheel/Rad Styrekugle/Tie rod end/Axialgelenk	16x1,5 RHT Inderste/Inner		
6	5032544 V/H - L/R 15" Hjul/Wheel/Rad Styrekugle/Tie rod end/Axialgelenk	16x1,5 RHT Inderste/Inner		
7	5042517 V/H - L/R Bærekugle/Ball joint/Radgelenk	Nederste/Lower/Unten		
8	5092518 Manchetsæt/Boot kit/Manschetten satz			
9	5102508 For/Front/Vorne Bøsning/Bushing/Buchsen	V/H - L/R	Udvendig/Outer/Außen	47,12 mm.
10	5102509 Bag/Rear/Hinten Bøsning/Bushing/Buchsen	V/H - L/R	Udvendig/Outer/Außen	60 mm.
11	5102520 Bag/Rear/Hinten Bøsning/Bushing/Buchsen	V/H - L/R	Udvendig/Outer/Außen	46,9 mm.
POS				
12	5112503 V/H - L/R 240 mm. Stabilisatorstang/Stabilizer rod/Diagonalstrebe			
Bagaksel/Rear axle/Hinterachse				
13	5012553 V/H - L/R Bærearmlenke/Track control arm/Querlenker			
14	5112510 V/H - L/R - 10/94 Ø10mm. 101 mm. Stabilisator/Stabilizer/Stabilisator			
15	5112511 V/H - L/R 11/94 - Ø10mm. 101 mm. Stabilisator/Stabilizer/Stabilisator			

POS	 Mondeo II & Mondeo Turnier II 9/96-				
Foraksel/Front axle/Vorneachse					
1	5012525 Venstre/Left/Links Bærearmlenke/Track control arm/Querlenker				
2	5012526 Højre/Right/Rechs Bærearmlenke/Track control arm/Querlenker	1	2	3	4
3	5032544 V/H - L/R 14" Hjul/Wheel/Rad 16x1,5 RHT Styrekugle/Tie rod end/Axialgelenk				
4	5032545 Venstre/Left/Links Styrekugle/Tie rod end/Kugelgelenk			5	6
5	5032546 Højre/Right/Rechs Styrekugle/Tie rod end/Kugelgelenk				
6	5032547 V/H - L/R 15" & 16" Hjul/Wheel/Rad 16x1,5 RHT Styrekugle/Tie rod end/Axialgelenk			7	8
7	5042517 ;V/H - L/R Bærekugle/Ball joint/Radgelenk;Nederste/Lower/Unten				9
8	5092518 Manchetsæt/Boot kit/Manschetten satz				
9	5102508 For/Front/Vorne Bøsning/Bushing/Buchsen	V/H - L/R	Udvendig/Outer/Außen	47,12 mm.	
10	5102509 Bag/Rear/Hinten Bøsning/Bushing/Buchsen;	V/H - L/R	Udvendig/Outer/Außen	60 mm.	
11	5102520 Bag/Rear/Hinten Bøsning/Bushing/Buchsen	V/H - L/R	Udvendig/Outer/Außen	46,9 mm.	
POS 					
12	5102527 For/Front/Vorne Bøsning/Bushing/Buchsen	V/H - L/R	Ø54mm.		
13	5112503 V/H - L/R 240 mm. Stabilisatorstang/Stabilizer rod/Diagonalstrebe				
Bagaksel/Rear axle/Hinterachse					
14	5012553 V/H - L/R Bærearmlenke/Track control arm/Querlenker			12	
15	5112511 V/H - L/R Ø10mm. 101 mm. Stabilisator/Stabilizer/Stabilisator		- 7/98		
16	5112512 V/H - L/R 160 mm. Stabilisator/Stabilizer/Stabilisator	8/98 -			
		15			
					16

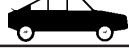
POS	Mondeo III & Mondeo Turnier III 11/00-			
Foraksel/Front axle/Vorneachse				
1	5012547 Venstre/Left/Links Bæream/Track control arm/Querlenker			
2	5012548 Højre/Right/Rechs Bæream/Track control arm/Querlenker			
3	5032544 V/H - L/R Styrekugle/Tie rod end/Axialgelenk	16x1,5 RHT Inderste/Inner		
4	5032557 V/H - L/R Styrekugle/Tie rod end/Kugelgelenk	16x1,5 RHT Yderste/Outer/Außen		
5	5042523 V/H - L/R Bærekugle/Ball joint/Radgelenk	Nederste/Lower/Unten		
6	5092518 Manchetsæt/Boot kit/Manschetten satz			
7	5102525 For/Front/Vorne Bøsning/Bushing/Buchsen	V/H - L/R		
8	5102526 Bag/Rear/Hinten Bøsning/Bushing/Buchsen	V/H - L/R		
9	5112521 V/H - L/R 250 mm. Stabilisator/Stabilizer/Stabilisator			
Bagaksel/Rear axle/Hinterachse				
10	5012554 For/Front/Vorne Bæream/Track control arm/Querlenker	V/H - L/R	550 mm.	
POS				
11	5012555 Bag/Rear/Hinten Bæream/Track control arm/Querlenker	V/H - L/R	600 mm.	
12	5112513 V/H - L/R (- Station Wagon) 255 mm. Stabilisator/Stabilizer/Stabilisator			
13	5112514 V/H - L/R (Station Wagon) 105 mm. Stabilisator/Stabilizer/Stabilisator			

POS	 Mondeo IV & Mondeo Turnier IV 3/07-
<p>1</p> <p>2</p>	<p>Foraksel/Front axle/Vorneachse</p> <p>Venstre/Left/Links Styrekugle/Tie rod end/Kugelgelenk</p> <p>Højre/Right/Rechs Styrekugle/Tie rod end/Kugelgelenk</p>
POS	





















POS	P 100 10/87-				
Foraksel/Front axle/Vorneachse					
1	5012505 Venstre/Left/Links Bærearml/Track control arm/Querlenker				
2	5012506 Højre/Right/Rechs Bærearml/Track control arm/Querlenker				
3	5032507 V/H - L/R Styrekugle/Tie rod end/Kugelgelenk	14x2 RHT Yderste/Outer/Außen			
4	5092515 (H.D)(**) Manchetsæt/Boot kit/Manschetten satz				
5	5092517 (H.D)(*) Manchetsæt/Boot kit/Manschetten satz				
6	5102505 For/Front/Vorne Bøsning/Bushing/Buchsen	V/H - L/R			
7	5102507 For/Front/Vorne (H.D) Bøsningssæt/Bushing set/Buchsen satz	V/H - L/R			
					(*) Uden Servo Styling Without Power Steering Ohne Servolenkung (**) Med Servo Styling With Power Steering Mit Servolenkung
POS	Puma 3/97-				
Foraksel/Front axle/Vorneachse					
1	5012529 Venstre/Left/Links Bærearml/Track control arm/Querlenker				
2	5012530 Højre/Right/Rechs Bærearml/Track control arm/Querlenker				
3	5032526 Venstre/Left/Links Styrekugle/Tie rod end/Kugelgelenk	12x1,5 RHT Yderste/Outer/Außen			
4	5032527 Højre/Right/Rechs Styrekugle/Tie rod end/Kugelgelenk	12x1,5 RHT Yderste/Outer/Außen			
5	5042516 Højre/Right/Rechs Bærekugle/Ball joint/Radgelenk	Nederste/Lower/Unten			
6	5092519 Manchetsæt/Boot kit/Manschetten satz				
7	5102512 For/Front/Vorne Bøsning/Bushing/Buchsen	V/H - L/R			
8	5102513 Bag/Rear/Hinten Bøsning/Bushing/Buchsen	V/H - L/R			
9	5112503 V/H - L/R 240 mm. Stabilisatorstang/Stabilizer rod/Diagonalstrebe				(*) Uden Servo Styling Without Power Steering Ohne Servolenkung (**) Med Servo Styling With Power Steering Mit Servolenkung

POS	 S-Max 5/06-
	<p>Foraksel/Front axle/Vorneachse</p> <p>1 Venstre/Left/Links Styrekugle/Tie rod end/Kugelgelenk</p> <p>2 Højre/Right/Rechs Styrekugle/Tie rod end/Kugelgelenk</p>
POS	

POS	Scorpio I 4/85-9/94				
Foraksel/Front axle/Vorneachse					
1	5012507 Venstre/Left/Links Bærearml/Track control arm/Querlenker	(-4WD)			
2	5012508 Højre/Right/Rechs Bærearml/Track control arm/Querlenker	(-4WD)			
3	5032504 Venstre/Left/Links Styrekugle/Tie rod end/Kugelgelenk	(4WD) 14x2 RHT			
4	5032505 Højre/Right/Rechs Styrekugle/Tie rod end/Kugelgelenk	(4WD) 14x2 RHT			
5	5032507 V/H - L/R Styrekugle/Tie rod end/Kugelgelenk	(-4WD) 14x2 RHT			
6	5092517 (*) Manchetsæt/Boot kit/Manschetten satz				
7	5102505 For/Front/Vorne Bøsning/Bushing/Buchsen	V/H - L/R			
8	5102507 For/Front/Vorne (H.D) Bøsningssæt/Bushing set/Buchsen satz	V/H - L/R			
9	5102517 Bag/Rear/Hinten Bøsning/Bushing/Buchsen	V/H - L/R	Udvendig/Outer/Außen10 mm.		
(*) Uden Servo Styling Without Power Steering Ohne Servolenkung					
POS	Scorpio II 10/94-8/98				
Foraksel/Front axle/Vorneachse					
1	5032554 V/H - L/R Styrekugle/Tie rod end/Axialgelenk;Inderste/Inner	16x1,5 RHT			
2	5032559 Venstre/Left/Links Styrekugle/Tie rod end/Kugelgelenk;Yderste/Outer/Außen	16x1,5 RHT			
3	5032560 Højre/Right/Rechs Styrekugle/Tie rod end/Kugelgelenk;Yderste/Outer/Außen	16x1,5 RHT			
4	5102505 For/Front/Vorne Bøsning/Bushing/Buchsen	V/H - L/R			
5	5102517;Bag/Rear/Hinten Bøsning/Bushing/Buchsen	V/H - L/R	Udvendig/Outer/Außen10 mm.		
6	5112515 V/H - L/R Stabilisator/Stabilizer/Stabilisator	270 mm.			
Bagaksel/Rear axle/Hinterachse					
7	5112516 V/H - L/R Stabilisator/Stabilizer/Stabilisator	Ø7mm. 127 mm.			

POS	Sierra 8/82-2/93		
Foraksel/Front axle/Vorneachse			
1	5012505 Venstre/Left/Links (- 4WD) Bærearmlenke/Track control arm/Querlenker		
2	5012506 Højre/Right/Rechts (- 4WD) Bærearmlenke/Track control arm/Querlenker		
3	5022507 (*) Tandstang/Steering rack/Zahnstange		
4	5032504 Venstre/Left/Links Styrekugle/Tie rod end/Kugelgelenk	14x2 RHT Yderste/Outer/Außen	
5	5032505 Højre/Right/Rechts Styrekugle/Tie rod end/Kugelgelenk	14x2 RHT Yderste/Outer/Außen	
6	5032506 V/H - L/R Styrekugle/Tie rod end/Axialgelenk	14x2 RHT Inderste/Inner	
7	5092517 Manchetsæt/Boot kit/Manschetten satz		
8	5102505 For/Front/Vorne V/H - L/R Bøsning/Bushing/Buchsen		
9	5102507 For/Front/Vorne V/H - L/R (H.D) Bøsningssæt/Bushing set/Buchsen satz		
			(*) Uden Servo Styling Without Power Steering Ohne Servolenkung
POS	Taunus 1970-82		
Foraksel/Front axle/Vorneachse			
1	5022506 Tandstang/Steering rack/Zahnstange		
2	5032503 V/H - L/R Styrekugle/Tie rod end/Kugelgelenk	14x2 RHT Yderste/Outer/Außen	
3	5042506 V/H - L/R Bærekugle/Ball joint/Radgelenk	Nederste/Lower/Unten	
4	5042507 V/H - L/R Bærekugle/Ball joint/Radgelenk	Øverste/Upper/Oben	
5	5092510 Manchetsæt/Boot kit/Manschetten satz		
6	5112501 V/H - L/R 190 mm. Stabilisator bolt/Stabilizer bolt/Stabilisator bolzen		
Bagaksel/Rear axle/Hinterachse			
7	5102501 Bag/Rear/Hinten V/H - L/R Bøsning/Bushing/Buchsen		
8	5102502 V/H - L/R Bøsning/Bushing/Buchsen Øverste/Upper/Oben		
9	5102503 For/Front/Vorne V/H - L/R Bøsning/Bushing/Buchsen		
10	5102504 V/H - L/R Bøsning/Bushing/Buchsen Nederste/Lower/Unten		

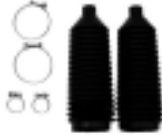





POS	Transit 1965-9/85				
Foraksel/Front axle/Vorneachse					
1	5032508 Højre/Right/Rechs Styrekugle/Tie rod end/Kugelgelenk	20x1,5 LHT Yderste/Outer/Außen		1	
2	5032509 Venstre/Left/Links Styrekugle/Tie rod end/Kugelgelenk	20x1,5 RHT Yderste/Outer/Außen		2	
POS	Transit (T) 80-120 (Tandstangsstyring 10/85-9/92)				
Foraksel/Front axle/Vorneachse					
1	5032519 V/H - L/R - 8/91 Styrekugle/Tie rod end/Kugelgelenk	16x1,5 RHT Yderste/Outer/Außen			
2	5032532 V/H - L/R 9/91 - Styrekugle/Tie rod end/Kugelgelenk	16x1,5 RHT Yderste/Outer/Außen			
3	5032533 V/H - L/R 9/91 - Styrekugle/Tie rod end/Axialgelenk	16x1,5 RHT Inderste/Inner			
4	5042510 V/H - L/R - 8/91 Bærekugle/Ball joint/Radgelenk	Nederste/Lower/Unten		4	
5	5042518 V/H - L/R 9/91 - Bærekugle/Ball joint/Radgelenk	Nederste/Lower/Unte		5	
6	5092520 (*) Manchetsæt/Boot kit/Manschetten satz			6	
7	5092521 (**) Manchetsæt/Boot kit/Manschetten satz			7	
8	5112507 Venstre/Left/Links Stabilisator/Stabilizer/Stabilisator	Ø16mm. 150 mm.		8	(*)
9	5112508 Højre/Right/Rechs Stabilisator/Stabilizer/Stabilisator	Ø16mm. 150 mm.		9	(**)
					(*) Uden Servo Styring Without Power Steering Ohne Servolenkung
					(**) Med Servo Styring With Power Steering Mit Servolenkung



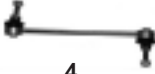

POS	 Transit (T_) 130-190 & 100L (Med Styrehus 10/85-9/92)		
Foraksel/Front axle/Vorneachse			
1	Højre/Right/Rechs 16x1,5 LHT - 7/87 Styrekugle/Tie rod end/Kugelgelenk		3
2	5002501 U Midt/Center/Mitte - 7/87 Styrestang/Steering rod/Spurstange		4
3	5002505 V/H - L/R 8/87 - (*) Styrestang langsgående/Steering rod - longitudinal/Spurstange in Längsrichtung		5
4	5002506 U V/H - L/R 8/87 - - 11/90 (**) Styrestang langsgående/Steering rod - longitudinal/Spurstange in Längsrichtung		6
5	5002507 V/H - L/R 12/90 - (**) Styrestang langsgående/Steering rod - longitudinal/Spurstange in Längsrichtung		6
6	5002508 Midt/Center/Mitte 8/87 - Styrestang/Steering rod/Spurstange		7
7	5032513 U Højre/Right/Rechs 20x1,5 RHT - 7/87 Styrekugle/Tie rod end/Kugelgelenk		8
8	5032514 Højre/Right/Rechs 16x1,5 LHT - 7/87 Styrekugle/Tie rod end/Kugelgelenk		9
9	5032515 Venstre/Left/Links 20x1,5 LHT - 7/87 Styrekugle/Tie rod end/Kugelgelenk		10
10	5032519 Venstre/Left/Links 16x1,5 RHT - 7/87 Styrekugle/Tie rod end/Kugelgelenk		11
11	5032548 Venstre/Left/Links 20 x 1,5 LHT 8/87 - Styrekugle/Tie rod end/Kugelgelenk		11
POS 			
12	5032549 Højre/Right/Rechs 8/87 - 20 x 1,5 RHT Styrekugle/Tie rod end/Kugelgelenk		12
13	5032550 Venstre/Left/Links 8/87 - 16 x 1,5 LHT Styrekugle/Tie rod end/Kugelgelenk		13
14	5032551 Højre/Right/Rechs 8/87 - 16 x 1,5 RHT Styrekugle/Tie rod end/Kugelgelenk		14
15	5042510 V/H - L/R - 8/91 Bærekugle/Ball joint/Radgelenk		15
16	5042518 V/H - L/R 9/91 - Bærekugle/Ball joint/Radgelenk		16
17	5092520 (*) Manchetsæt/Boot kit/Manschetten satz		17
18	5092521 (**) Manchetsæt/Boot kit/Manschetten satz		18

(*) Uden Servo Styling
 Without Power Steering
 Ohne Servolenkung



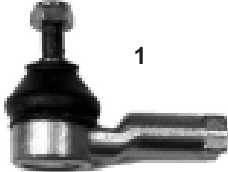



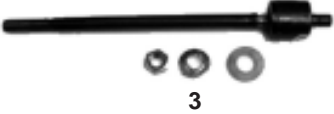

















(**) Med Servo Styling
 With Power Steering
 Mit Servolenkung













POS	Transit (E_) 9/91-3/00				
Foraksel/Front axle/Vorneachse					
1	5032532 V/H - L/R 16x1,5 RHT Styrekugle/Tie rod end/Kugelgelenk	Yderste/Outer/Außen			
2	5032533 V/H - L/R 16x1,5 RHT Styrekugle/Tie rod end/Axialgelenk	Inderste/Inner			
3	5042518 Bærekugle/Ball joint/Radgelenk	Nederste/Lower/Unten			
4	5092520 (*) Manchetsæt/Boot kit/Manschetten satz				
5	5092521 (**) Manchetsæt/Boot kit/Manschetten satz				
6	5112507 Venstre/Left/Links Stabilisator/Stabilizer/Stabilisator	Ø16mm. 150 mm.			
7	5112508 Højre/Right/Rechs Stabilisator/Stabilizer/Stabilisator	Ø16mm. 150 mm.			
POS Transit (F#_Y, F#_Y) 3/00-					
Foraksel/Front axle/Vorneachse					
1	5012549 Venstre/Left/Links Bærearm/Track control arm/Querlenker				
2	5012550 Højre/Right/Rechs Bærearm/Track control arm/Querlenker				
3	5032561 V/H - L/R 16x1,5 RHT Styrekugle/Tie rod end/Kugelgelenk	Yderste/Outer/Außen			
4	5032563 Venstre/Left/Links 16x1,5/20x1,5 RHT Styrekugle/Tie rod end/Axialgelenk	Inderste/Inner			
5	5032564 Højre/Right/Rechs 16x1,5/16x1,5 RHT Styrekugle/Tie rod end/Axialgelenk	Inderste/Inner			
6	5042524 V/H - L/R Bærekugle/Ball joint/Radgelenk	Nederste/Lower/Unten			
7	5092524 Manchetsæt/Boot kit/Manschetten satz				
8	5102528 Bag/Rear/Hinten V/H - L/R Bøsning/Bushing/Buchsen	Nederste/Lower/Unten			
9	5112519 V/H - L/R 195 mm. Stabilisator/Stabilizer/Stabilisator				
					(*) Uden Servo Styling Without Power Steering Ohne Servolenkung
					(**) Med Servo Styling With Power Steering Mit Servolenkung



POS	 Transit Connect 9/02-
Foraksel/Front axle/Vorneachse	
1	<p>5032553 V/H - L/R 14x2 RHT Styrekugle/Tie rod end/Axialgelenk Inderste/Inner</p> 
2	<p>5032565 V/H - L/R Styrekugle/Tie rod end/Kugelgelenk Yderste/Outer/Außen</p> 
3	<p>5042524 V/H - L/R Bærekugle/Ball joint/Radgelenk Nederste/Lower/Unten</p> 
4	<p>5112517 V/H - L/R Stabilisatorstang/Stabilizer rod/Diagonalstrebe</p> 
Bagaksel/Rear axle/Hinterachse	
5	<p>5112518 V/H - L/R Stabilisator/Stabilizer/Stabilisator</p> 
POS	 Transit 7/06-



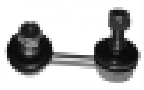

<p>POS</p>	<p> Accord I SJ/SM/SV 5/76-8/81</p>
<p>Foraksel/Front axle/Vorneachse</p> <p>1 5032601 V/H - L/R 12x1,5 RHT Styrekugle/Tie rod end/Kugelgelenk Yderste/Outer/Außen</p> 	
<p>POS</p>	<p> Accord I SY/SZ 9/81-5/83</p>
<p>Foraksel/Front axle/Vorneachse</p> <p>1 5012607 U Venstre/Left/Links Bærearmlenke/Track control arm/Querlenker</p> <p>2 5032601 V/H - L/R 12x1,5 RHT Styrekugle/Tie rod end/Kugelgelenk Yderste/Outer/Außen</p> <p>3 5032603 U V/H - L/R 12x1,25 RHT Styrekugle/Tie rod end/Axialgelenk Inderste/Inner</p>   	

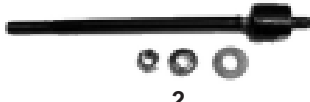

POS	Accord II AC/AD 6/83-4/85			
		Foraksel/Front axle/Vorneachse		
1	5012607 U Venstre/Left/Links Bæream/Track control arm/Querlenker			1
2	5032601 V/H - L/R Styrekugle/Tie rod end/Kugelgelenk Foraksel/Front axle/Vorneachse	12x1,5 RHT Yderste/Outer/Außen		2
POS	Accord III CA4/CA5 5/85-12/89			
1	5012613 U Venstre/Left/Links Bæream/Track control arm/Querlenker	Nederste/Lower/Unten		1
2	5012614 U Højre/Right/Rechs Bæream/Track control arm/Querlenker	Nederste/Lower/Unten		2
3	5012615 U Venstre/Left/Links Bæream/Track control arm/Querlenker	Øverste/Upper/Oben		3
4	5012616 U Højre/Right/Rechs Bæream/Track control arm/Querlenker	Øverste/Upper/Oben		4
5	5032601 V/H - L/R Styrekugle/Tie rod end/Kugelgelenk	12x1,5 RHT Yderste/Outer/Außen		5
6	5032603 U V/H - L/R Styrekugle/Tie rod end/Axialgelenk	12x1,25 RHT Inderste/Inner		6
7	5042602 V/H - L/R Bærekugle/Ball joint/Radgelenk	Nederste/Lower/Unten		7
				8
		Bagaksel/Rear axle/Hinterachse		
8	5012619 V/H - L/R Bæream/Track control arm/Querlenker			



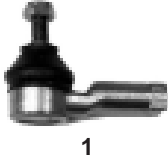

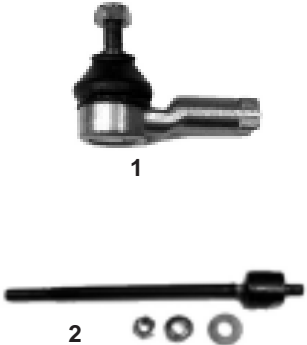

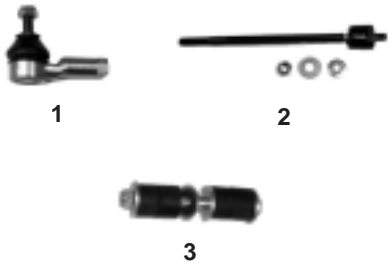

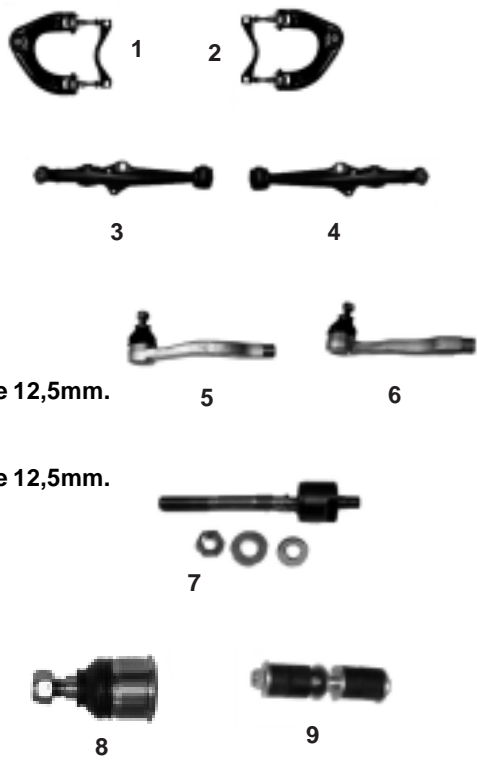



POS	Accord IV CB3/CB7/CB8/CC1/CC9 1/90-12/93
Foraksel/Front axle/Vorneachse	
1	5012617 Venstre/Left/Links Bærearml/Track control arm/Querlenker Øverste/Upper/Oben  
2	5012618 Højre/Right/Rechs Bærearml/Track control arm/Querlenker Øverste/Upper/Oben  
3	5032610 Venstre/Left/Links 14x1,5 RHT Konus/Cone 13mm. Styrekugle/Tie rod end/Kugelgelenk Yderste/Outer/Außen  
4	5032611 Højre/Right/Rechs 14x1,5 RHT Konus/Cone 13mm. Styrekugle/Tie rod end/Kugelgelenk Yderste/Outer/Außen 
5	5032612 V/H - L/R 14x1,5 RHT Styrekugle/Tie rod end/Axialgelenk Inderste/Inner 
6	5042603 V/H - L/R Bærekugle/Ball joint/Radgelenk Nederste/Lower/Unten 
Bagaksel/Rear axle/Hinterachse	
7	5012620 Højre/Right/Rechs Bærearml/Track control arm/Querlenker  
8	5012641 Venstre/Left/Links Bærearml/Track control arm/Querlenker
POS	Accord V & VI CC7/CD7/CD9/CE1/CE2/CD7/CD8/CD9/CF1 3/93-10/98
Foraksel/Front axle/Vorneachse	
1	5012617 Venstre/Left/Links (-Coupe & Kombi) Bærearml/Track control arm/Querlenker Øverste/Upper/Oben  
2	5012618 Højre/Right/Rechs (-Coupe & Kombi) Bærearml/Track control arm/Querlenker Øverste/Upper/Oben  
3	5012621 Venstre/Left/Links (Coupe & Kombi) Bærearml/Track control arm/Querlenker Øverste/Upper/Oben  
4	5012622 Højre/Right/Rechs (Coupe & Kombi) Bærearml/Track control arm/Querlenker Øverste/Upper/Oben  
5	5032610 Venstre/Left/Links 14x1,5 RHT Konus/Cone 13mm. Styrekugle/Tie rod end/Kugelgelenk Yderste/Outer/Außen  
6	5032611 Højre/Right/Rechs 14x1,5 RHT Konus/Cone 13mm. Styrekugle/Tie rod end/Kugelgelenk Yderste/Outer/Außen 
7	5032612 V/H - L/R (-Coupe) 14x1,5 RHT Styrekugle/Tie rod end/Axialgelenk Inderste/Inner 
8	5042603 V/H - L/R Bærekugle/Ball joint/Radgelenk Nederste/Lower/Unten 

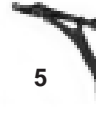













POS	 Accord V & VI CC7/CD7/CD9/CE1/CE2/CD7/CD8/CD9/CF1 3/93-10/98
Bagaksel/Rear axle/Hinterachse	
9	5012620 Højre/Right/Rechs Bærearmlenke/Track control arm/Querlenker  9
10	5012641 Venstre/Left/Links Bærearmlenke/Track control arm/Querlenker  10
POS	 Accord VII CG/CH 10/98-
Foraksel/Front axle/Vorneachse	
1	5012627 Venstre/Left/Links Bærearmlenke/Track control arm/Querlenker Øverste/Upper/Oben  1
2	5012628 Højre/Right/Rechs Bærearmlenke/Track control arm/Querlenker Øverste/Upper/Oben  2
3	5012629 Venstre/Left/Links Bærearmlenke/Track control arm/Querlenker Nederste/Lower/Unten  3
4	5012630 Højre/Right/Rechs Bærearmlenke/Track control arm/Querlenker Nederste/Lower/Unten  4
5	5032617 Venstre/Left/Links Styrekugle/Tie rod end/Kugelgelenk Yderste/Outer/Außen  5
6	5032618 Højre/Right/Rechs Styrekugle/Tie rod end/Kugelgelenk Yderste/Outer/Außen  6
7	5042607 V/H - L/R Bærekugle/Ball joint/Radgelenk Øverste/Upper/Oben
8	5112603 Venstre/Left/Links 75 mm. Stabilisator bolt/Stabilizer bolt/Stabilisator bolzen  8
9	5112604 Højre/Right/Rechs 75 mm. Stabilisator bolt/Stabilizer bolt/Stabilisator bolzen  9

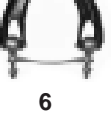

POS	 Accord VIII 2/03-	
Foraksel/Front axle/Vorneachse		
1	5112613 Venstre/Left/Links (CL) 82 mm. Stabilisator/Stabilizer/Stabilisator	
2	5112614 Højre/Right/Rechs (CL) 82 mm. Stabilisator/Stabilizer/Stabilisator	
3	5112615 Venstre/Left/Links (CM) 72 mm. Stabilisator/Stabilizer/Stabilisator	
4	5112616 Højre/Right/Rechs (CM) 72 mm. Stabilisator/Stabilizer/Stabilisator	
Bagaksel/Rear axle/Hinterachse		
5	5112617 V/H - L/R 127 mm. (CM) Stabilisator/Stabilizer/Stabilisator	
POS	 Ballade 1980-83	
Foraksel/Front axle/Vorneachse		
1	5032601 V/H - L/R 12x1,5 RHT Styrekugle/Tie rod end/Kugelgelenk Yderste/Outer/Außen	 <p>1</p>
2	5032603 U V/H - L/R 12x1,25 RHT Styrekugle/Tie rod end/Axialgelenk Inderste/Inner	
		 <p>2</p>

POS	 Ballade 1983-86
Foraksel/Front axle/Vorneachse	
1	5032601 V/H - L/R 12x1,5 RHT Styrekugle/Tie rod end/Kugelgelenk Yderste/Outer/Außen
2	5032604 U V/H - L/R 12x1,25 RHT Styrekugle/Tie rod end/Axialgelenk Inderste/Inner
	
POS	 Civic SC/SF/SG/SH/SK/SP 1975-6/79
Foraksel/Front axle/Vorneachse	
1	5032601 V/H - L/R 12x1,5 RHT Styrekugle/Tie rod end/Kugelgelenk Yderste/Outer/Außen
	
POS	 Civic SL/SR/SS/ST/VC/VE/WD 7/79-8/83
Foraksel/Front axle/Vorneachse	
1	5032601 V/H - L/R 12x1,5 RHT Styrekugle/Tie rod end/Kugelgelenk Yderste/Outer/Außen
2	5032603 U V/H - L/R 12x1,25 RHT Styrekugle/Tie rod end/Axialgelenk Inderste/Inner
	

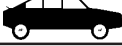



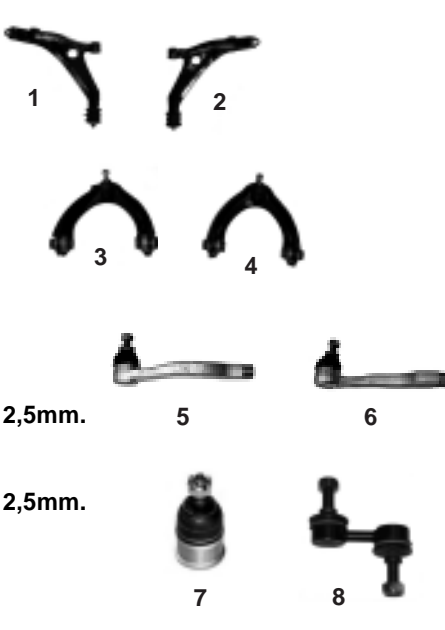



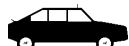
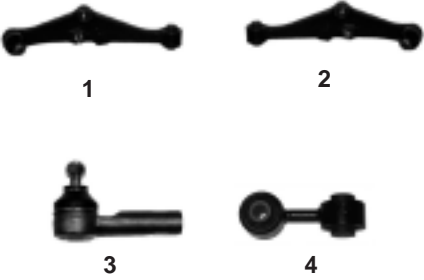

POS	 Civic AG/AH/AJ/AK/AR/AT/AU/VJ 10/83-10/87 & Civic CRX AE/AF/AS 10/83-10/87
Foraksel/Front axle/Vorneachse	
1	5032601 V/H - L/R Styrekugle/Tie rod end/Kugelgelenk 12x1,5 RHT Yderste/Outer/Außen
2	5032604 U V/H - L/R Styrekugle/Tie rod end/Axialgelenk 12x1,25 RHT Inderste/Inner
3	5112601 V/H - L/R Stabilisator bolt/Stabilizer bolt/Stabilisator bolzen 110 mm.
	
POS	 Civic CRX EF 10/87-2/92 & Civic EC/ED/EE/EF/EY 10/87-9/91
Foraksel/Front axle/Vorneachse	
1	5012611 Venstre/Left/Links Bærearmlenke/Track control arm/Querlenker Øverste/Upper/Oben
2	5012612 Højre/Right/Rechts Bærearmlenke/Track control arm/Querlenker Øverste/Upper/Oben
3	5012623 Venstre/Left/Links Bærearmlenke/Track control arm/Querlenker Nederste/Lower/Unten
4	5012624 Højre/Right/Rechts Bærearmlenke/Track control arm/Querlenker Nederste/Lower/Unten
5	5032606 Venstre/Left/Links Styrekugle/Tie rod end/Kugelgelenk 14x1,5 RHT Konus/Cone 12,5mm. Yderste/Outer/Außen
6	5032607 Højre/Right/Rechts Styrekugle/Tie rod end/Kugelgelenk 14x1,5 RHT Konus/Cone 12,5mm. Yderste/Outer/Außen
7	5032608 V/H - L/R Styrekugle/Tie rod end/Axialgelenk 14x1,5 RHT Inderste/Inner
8	5042602 V/H - L/R Bærekugle/Ball joint/Radgelenk Nederste/Lower/Unten
9	5112601 V/H - L/R Stabilisator bolt/Stabilizer bolt/Stabilisator bolzen 110 mm.
	

POS		Civic CRX EH6/EG2 3/92-12/98 & Civic EG3/EG4/EG5/EG6/EG7/EG8/EG9/EH1/EJ2 10/91-11/95		
Foraksel/Front axle/Vorneachse				
1	5012625 Venstre/Left/Links Bæream/Track control arm/Querlenker	Øverste/Upper/Oben		
2	5012626 Højre/Right/Rechs Bæream/Track control arm/Querlenker	Øverste/Upper/Oben		
3	5012631 Venstre/Left/Links Bæream/Track control arm/Querlenker	(-Vti/Vtec/CRX) Nederste/Lower/Unten		
4	5012632 Højre/Right/Rechs Bæream/Track control arm/Querlenker	(-Vti/Vtec/CRX) Nederste/Lower/Unten		
5	5012639 Venstre/Left/Links Bæream/Track control arm/Querlenker	(Vti/Vtec/CRX) Nederste/Lower/Unten		
6	5012640 Højre/Right/Rechs Bæream/Track control arm/Querlenker	(Vti/Vtec/CRX) Nederste/Lower/Unten		
7	5032606 Venstre/Left/Links Styrekugle/Tie rod end/Kugelgelenk	14x1,5 RHT Konus/Cone 12,5mm. Yderste/Outer/Außen		
8	5032607 Højre/Right/Rechs Styrekugle/Tie rod end/Kugelgelenk	14x1,5 RHT Konus/Cone 12,5mm. Yderste/Outer/Außen		
9	5032609 V/H - L/R Styrekugle/Tie rod end/Axialgelenk	14x1,5 RHT Inderste/Inner		
POS				
10	5042604 V/H - L/R Bærekugle/Ball joint/Radgelenk	Nederste/Lower/Unten		
11	5112601 V/H - L/R 110 mm. Stabilisator bolt/Stabilizer bolt/Stabilisator bolzen			

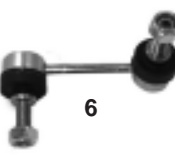
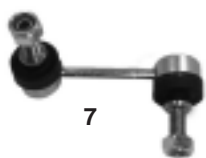
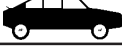

POS		Civic MA/MB/MC 9/94-2/01		
Foraksel/Front axle/Vorneachse				
1	5012625	Venstre/Left/Links	(1.4i)	
		Bærearml/Track control arm/Querlenker	Øverste/Upper/Ober	
2	5012626	Højre/Right/Rechs	(1.4i)	
		Bærearml/Track control arm/Querlenker	Øverste/Upper/Ober	
3	5012631	Venstre/Left/Links		
		Bærearml/Track control arm/Querlenker	Nederste/Lower/Unten	
4	5012632	Højre/Right/Rechs		
		Bærearml/Track control arm/Querlenker	Nederste/Lower/Unten	
5	5012637	Venstre/Left/Links	(-1.4i)	
		Bærearml/Track control arm/Querlenker	Øverste/Upper/Ober	
6	5012638	Højre/Right/Rechs	(-1.4i)	
		Bærearml/Track control arm/Querlenker	Øverste/Upper/Ober	
7	5032606	Venstre/Left/Links	14x1,5 RHT Konus/Cone 12,5mm.	
		Styrekugle/Tie rod end/Kugelgelenk	Yderste/Outer/Außen	
8	5032607	Højre/Right/Rechs	14x1,5 RHT Konus/Cone 12,5mm.	
		Styrekugle/Tie rod end/Kugelgelenk	Yderste/Outer/Außen	
9	5032609	V/H - L/R (-MC)	14x1,5 RHT	
		Styrekugle/Tie rod end/Axialgelenk	Inderste/Inner	
10	5042604	V/H - L/R		
		Bærekugle/Ball joint/Radgelenk	Nederste/Lower/Unten	
POS				
11	5112607	V/H - L/R	80 mm.	
		Stabilisator bolt/Stabilizer bolt/Stabilisator bolzen		





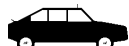

POS		Civic EJ6/EJ8/EJ9/EK3/EK4 11/95-2/01
Foraksel/Front axle/Vorneachse		
1	5012633 Venstre/Left/Links Bærearml/Track control arm/Querlenker	Nederste/Lower/Unten
2	5012634 Højre/Right/Rechs Bærearml/Track control arm/Querlenker	Nederste/Lower/Unten
3	5012635 Venstre/Left/Links Bærearml/Track control arm/Querlenker	Øverste/Upper/Oben
4	5012636 Højre/Right/Rechs Bærearml/Track control arm/Querlenker	Øverste/Upper/Oben
5	5032606 Venstre/Left/Links Styrekugle/Tie rod end/Kugelgelenk	14x1,5 RHT Konus/Cone 12,5mm. Yderste/Outer/Außen
6	5032607 Højre/Right/Rechs Styrekugle/Tie rod end/Kugelgelenk	14x1,5 RHT Konus/Cone 12,5mm. Yderste/Outer/Außen
7	5042604 V/H - L/R Bærekugle/Ball joint/Radgelenk	Nederste/Lower/Unten
8	5112602 V/H - L/R 55 mm. Stabilisator bolt/Stabilizer bolt/Stabilisator bolzen	
		
POS		
Bagaksel/Rear axle/Hinterachse		
9	5112605 Venstre/Left/Links Stabilisator bolt/Stabilizer bolt/Stabilisator bolzen	70 mm.
10	5112606 Højre/Right/Rechs Stabilisator bolt/Stabilizer bolt/Stabilisator bolzen	70 mm.
		



POS	 Civic VI 2/01-
POS	 Concerto HW 8/89-3/95
<p>Foraksel/Front axle/Vorneachse</p>	
1	<p>5014001 Venstre/Left/Links Bæream/Track control arm/Querlenker Nederste/Lower/Unten</p>
2	<p>5014002 Højre/Right/Rechs Bæream/Track control arm/Querlenker Nederste/Lower/Unten</p>
3	<p>5034001 V/H - L/R 14x1,5 RHT Styrekugle/Tie rod end/Kugelgelenk Yderste/Outer/Außen</p>
4	<p>5112608 V/H - L/R Ø10 mm. 67 mm. Stabilisator bolt/Stabilizer bolt/Stabilisator bolzen</p>
	



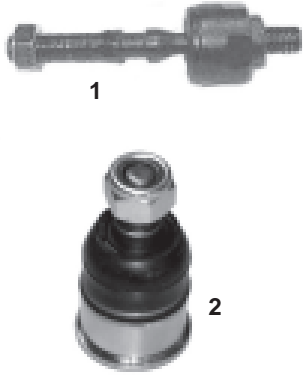

POS	 CR-V RD 10/95-			
Foraksel/Front axle/Vorneachse				
1	5032606 Venstre/Left/Links Styrekugle/Tie rod end/Kugelgelenk	14x1,5 RHT Konus/Cone 12,5mm. Yderste/Outer/Außen		
2	5032607 Højre/Right/Rechs Styrekugle/Tie rod end/Kugelgelenk	14x1,5 RHT Konus/Cone 12,5mm. Yderste/Outer/Außen		
3	5032623 V/H - L/R Styrekugle/Tie rod end/Axialgelenk	Inderste/Inner		
4	5042604 V/H - L/R Bærekugle/Ball joint/Radgelenk	Nederste/Lower/Unten		
5	5112602 V/H - L/R Stabilisator bolt/Stabilizer bolt/Stabilisator bolzen	55 mm.		
Bagaksel/Rear axle/Hinterachse				
6	5112611 Venstre/Left/Links Stabilisator/Stabilizer/Stabilisator	126 mm.		
7	5112612 Højre/Right/Rechs Stabilisator/Stabilizer/Stabilisator	126 mm.		
POS	 HR-V (GH) 3/99-			
Foraksel/Front axle/Vorneachse				
1	5032624 V/H - L/R Styrekugle/Tie rod end/Kugelgelenk	Yderste/Outer/Außen		
2	5032625 V/H - L/R Styrekugle/Tie rod end/Axialgelenk	Inderste/Inner		
3	5042608 V/H - L/R Bærekugle/Ball joint/Radgelenk	Nederste/Lower/Unten		
4	5112619 Venstre/Left/Links Stabilisator/Stabilizer/Stabilisator			
5	5112620 Højre/Right/Rechs Stabilisator/Stabilizer/Stabilisator			

POS	Integra DC2 11/97-10/01			
Foraksel/Front axle/Vorneachse				
1	5032606 Venstre/Left/Links Styrekugle/Tie rod end/Kugelgelenk	14x1,5 RHT Konus/Cone 12,5mm. Yderste/Outer/Außen		1
2	5032607 Højre/Right/Rechs Styrekugle/Tie rod end/Kugelgelenk	14x1,5 RHT Konus/Cone 12,5mm. Yderste/Outer/Außen		2
3	5042604 V/H - L/R Bærekugle/Ball joint/Radgelenk	Nederste/Lower/Unten		3
4	5112607 V/H - L/R 80 mm. Stabilisator bolt/Stabilizer bolt/Stabilisator bolzen			4
POS	Jazz (GD) 3/02-			
Foraksel/Front axle/Vorneachse				
1	5032619 Venstre/Left/Links Styrekugle/Tie rod end/Kugelgelenk	Yderste/Outer/Außen		1
2	5032620 Højre/Right/Rechs Styrekugle/Tie rod end/Kugelgelenk	Yderste/Outer/Außen		2
3	5032621 Venstre/Left/Links Styrekugle/Tie rod end/Axialgelenk	Inderste/Inner		3/4
4	5032622 Højre/Right/Rechs Styrekugle/Tie rod end/Axialgelenk	Inderste/Inner		5
5	5042606 V/H - L/R Bærekugle/Ball joint/Radgelenk	Nederste/Lower/Unten		6
6	5112609 Venstre/Left/Links Stabilisatorstang/Stabilizer rod/Diagonalstrebe	303 mm.		7
7	5112610 Højre/Right/Rechs Stabilisatorstang/Stabilizer rod/Diagonalstrebe	303 mm.		8
8	XXXXXXX Venstre/Left/Links Bærearmlenke/Track control arm/Querlenker	Nederste/Lower/Unten		9
9	XXXXXXX Højre/Right/Rechs Bærearmlenke/Track control arm/Querlenker	Nederste/Lower/Unten		



POS	 Logo (GA3) 3/99-3/02				
	Foraksel/Front axle/Vorneachse				
1	5032624 V/H - L/R Styrekugle/Tie rod end/Kugelgelenk		Yderste/Outer/Außen		
POS	 Prelude SN 11/78-10/82				
	Foraksel/Front axle/Vorneachse				
1	5032601 V/H - L/R Styrekugle/Tie rod end/Kugelgelenk	12x1,5 RHT Yderste/Outer/Außen			
2	5032603 U V/H - L/R Styrekugle/Tie rod end/Axialgelenk	12x1,25 RHT Inderste/Inner	1	2	

POS	 Prelude AB 2/83-4/87
Foraksel/Front axle/Vorneachse	
1	5032601 V/H - L/R Styrekugle/Tie rod end/Kugelgelenk 12x1,5 RHT Yderste/Outer/Außen
2	5042602 V/H - L/R Bærekugle/Ball joint/Radgelenk Nederste/Lower/Unten
	 1
	 2
POS	 Prelude BA 4/87-1/92 & Prelude BA1 6/85-4/87 & Prelude BA4 4/87-1/92 & Prelude BA5 4WS 4/87-1/92
Foraksel/Front axle/Vorneachse	
1	5032613 U V/H - L/R Styrekugle/Tie rod end/Kugelgelenk 12x1,25 RHT Konus/Cone 14mm. Yderste/Outer/Außen
2	5042602 V/H - L/R Bærekugle/Ball joint/Radgelenk Nederste/Lower/Unten
	 1
	 2













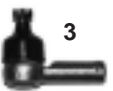

POS	 Prelude BB 2/92-
Foraksel/Front axle/Vorneachse	
1	5032614 V/H - L/R 14x1,5 RHT Styrekugle/Tie rod end/Axialgelenk Inderste/Inner
2	5042605 V/H - L/R Bærekugle/Ball joint/Radgelenk
	
POS	 Quintet SU 2/80-12/84
Foraksel/Front axle/Vorneachse	
1	5032601 V/H - L/R 12x1,5 RHT Styrekugle/Tie rod end/Kugelgelenk Yderste/Outer/Außen
2	5032603 U V/H - L/R 12x1,25 RHT Styrekugle/Tie rod end/Axialgelenk Inderste/Inner
	

POS	 Shuttle RA1 10/94-5/01
Foraksel/Front axle/Vorneachse	
1	<p>5032617 Venstre/Left/Links Styrekugle/Tie rod end/Kugelgelenk Yderste/Outer/Außen</p> 
2	<p>5032618 Højre/Right/Rechs Styrekugle/Tie rod end/Kugelgelenk Yderste/Outer/Außen</p> 
3	<p>5042603 V/H - L/R Bærekugle/Ball joint/Radgelenk Nederste/Lower/Unten</p> 
POS	

HONDA











POS	
POS	



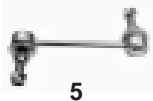





POS	Accent X3 10/94-01/00			
Foraksel/Front axle/Vorneachse				
1	5013401 Venstre/Left/Links Bærearml/Track control arm/Querlenker	Nederste/Lower/Unten		
2	5013402 Højre/Right/Rechs Bærearml/Track control arm/Querlenker	Nederste/Lower/Unten		
3	5033401 V/H - L/R Styrekugle/Tie rod end/Kugelgelenk	14x1,5 RHT Yderste/Outer/Außen		
4	5033402 V/H - L/R Styrekugle/Tie rod end/Axialgelenk	14x1,5 RHT Inderste/Inner		
5	5043401 V/H - L/R Bærekugle/Ball joint/Radgelenk	Nederste/Lower/Unten		
6	5043404 V/H - L/R Bærekugle/Ball joint/Radgelenk	Øverste/Upper/Oben		
7	5093401 Manchetsæt/Boot kit/Manschetten satz			
8	5103401 Bag/Rear/Hinten Venstre/Left/Links Bøsning/Bushing/Buchsen			
9	5103402 Bag/Rear/Hinten Højre/Right/Rechs Bøsning/Bushing/Buchsen			
10	5103403 For/Front/Vorne V/H - L/R Bøsning/Bushing/Buchsen			
POS				
11	5113204 V/H - L/R 130 mm. Stabilisator bolt/Stabilizer bolt/Stabilisator bolzen			







POS	Accent LC 01/00-
Foraksel/Front axle/Vorneachse	
1	5013409 Venstre/Left/Links Bæream/Track control arm/Querlenker Nederste/Lower/Unten 
2	5013410 Højre/Right/Rechs Bæream/Track control arm/Querlenker Nederste/Lower/Unten 
3	5033407 V/H - L/R 14x1,5 RHT Styrekugle/Tie rod end/Kugelgelenk Yderste/Outer/Außen 
4	5033408 V/H - L/R Styrekugle/Tie rod end/Axialgelenk Inderste/Inner 
5	5043405 V/H - L/R Bærekugle/Ball joint/Radgelenk Nederste/Lower/Unten 
6	5093401 Manchetsæt/Boot kit/Manschetten satz
7	5113401 Venstre/Left/Links 63 mm. Stabilisator bolt/Stabilizer bolt/Stabilisator bolzen 
8	5113402 Højre/Right/Rechs 63 mm. Stabilisator bolt/Stabilizer bolt/Stabilisator bolzen 
Bagaksel/Rear axle/Hinterachse	
9	5113403 V/H - L/R Stabilisator bolt/Stabilizer bolt/Stabilisator bolzen 
POS	Atos MX 2/98-
Foraksel/Front axle/Vorneachse	
1	5013403 Venstre/Left/Links Bæream/Track control arm/Querlenker Nederste/Lower/Unten 
2	5013404 Højre/Right/Rechs Bæream/Track control arm/Querlenker Nederste/Lower/Unten 
3	5033014 V/H - L/R 12x1,25 RHT Styrekugle/Tie rod end/Kugelgelenk Yderste/Outer/Außen 
4	5033409 V/H - L/R 12x1,25 Styrekugle/Tie rod end/Axialgelenk Inderste/Inner 
5	5043406 V/H - L/R Bærekugle/Ball joint/Radgelenk Nederste/Lower/Unten 
6	5093402 Manchetsæt/Boot kit/Manschetten satz 
7	5113404 V/H - L/R Stabilisator/Stabilizer/Stabilisator 





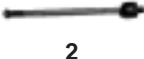

POS	Coupe RD 8/96-4/02				
Foraksel/Front axle/Vorneachse					
1	5013405 Venstre/Left/Links Bærearml/Track control arm/Querlenker	Nederste/Lower/Unten			
2	5013406 Højre/Right/Rechs Bærearml/Track control arm/Querlenker	Nederste/Lower/Unten			
3	5033401 V/H - L/R Styrekugle/Tie rod end/Kugelgelenk	14x1,5 RHT Yderste/Outer/Außen			
4	5033406 V/H - L/R Styrekugle/Tie rod end/Axialgelenk	14x1,5 RHT Inderste/Inner			
5	5043403 V/H - L/R Bærekugle/Ball joint/Radgelenk	Nederste/Lower/Unten			
6	5043404 V/H - L/R Bærekugle/Ball joint/Radgelenk	Øverste/Upper/Oben			
7	5093401 Manchetsæt/Boot kit/Manschetten satz				
8	5114507 V/H - L/R 61 mm. Stabilisatorstang/Stabilizer rod/Diagonalstrebe				
Bagaksel/Rear axle/Hinterachse					
9	5113405 V/H - L/R 135 mm. Stabilisatorstang/Stabilizer rod/Diagonalstrebe				
POS	Coupe GK 3/02-				
Foraksel/Front axle/Vorneachse					
1	5033407 V/H - L/R Styrekugle/Tie rod end/Kugelgelenk	14x1,5 RHT Yderste/Outer/Außen			
2	5033414 V/H - L/R Styrekugle/Tie rod end/Axialgelenk	14x1,5 RHT Inderste/Inner			
3	5043401 V/H - L/R Bærekugle/Ball joint/Radgelenk	Nederste/Lower/Unten			
4	5113421 Venstre/Left/Links Stabilisatorstang/Stabilizer rod/Diagonalstrebe	287 mm.			
5	5113422 Højre/Right/Rechs Stabilisatorstang/Stabilizer rod/Diagonalstrebe	287 mm.			
Bagaksel/Rear axle/Hinterachse					
6	5113405 V/H - L/R Stabilisatorstang/Stabilizer rod/Diagonalstrebe	135 mm.			

POS	Elantra (Lantra) J1 10/90-10/95
Foraksel/Front axle/Vorneachse	
1	5033014 V/H - L/R Styrekugle/Tie rod end/Kugelgelenk 12x1,25 RHT - 1/92 Yderste/Outer/Außen
2	5033403 V/H - L/R Styrekugle/Tie rod end/Kugelgelenk 14x1,5 RHT 1/92 - Yderste/Outer/Außen
3	5033404 V/H - L/R Styrekugle/Tie rod end/Axialgelenk 12x1,25 RHT - 1/92 Inderste/Inner
4	5033405 V/H - L/R Styrekugle/Tie rod end/Axialgelenk 14x1,5 RHT 1/92 - Inderste/Inner
5	5043402 U V/H - L/R Bærekugle/Ball joint/Radgelenk Nederste/Lower/Unten
6	5114507 V/H - L/R Stabilisatorstang/Stabilizer rod/Diagonalstrebe 61 mm.
Foraksel/Front axle/Vorneachse	
1	5013405 Venstre/Left/Links Bærearmlenke/Track control arm/Querlenker Nederste/Lower/Unten
2	5013406 Højre/Right/Rechts Bærearmlenke/Track control arm/Querlenker Nederste/Lower/Unten
3	5033401 V/H - L/R Styrekugle/Tie rod end/Kugelgelenk 14x1,5 RHT Yderste/Outer/Außen
4	5033406 V/H - L/R Styrekugle/Tie rod end/Axialgelenk 14x1,5 RHT Inderste/Inner
5	5043401 V/H - L/R Bærekugle/Ball joint/Radgelenk Nederste/Lower/Unten
6	5092524 Manchetsæt/Boot kit/Manschetten satz
7	5114507 V/H - L/R Stabilisatorstang/Stabilizer rod/Diagonalstrebe 61 mm.
Bagaksel/Rear axle/Hinterachse	
8	5113405 V/H - L/R Stabilisatorstang/Stabilizer rod/Diagonalstrebe 135 mm.







POS	Elantra XD 6/00-
Foraksel/Front axle/Vorneachse	
1	5033407 V/H - L/R Styrekugle/Tie rod end/Kugelgelenk 14x1,5 RHT Yderste/Outer/Außen 
2	5033414 V/H - L/R Styrekugle/Tie rod end/Axialgelenk 14x1,5 RHT Inderste/Inner 
3	5043405 V/H - L/R Bærekugle/Ball joint/Radgelenk Nederste/Lower/Unten 
4	5113408 V/H - L/R 50 mm. Stabilisator/Stabilizer/Stabilisator 
Bagaksel/Rear axle/Hinterachse	
5	5113405 V/H - L/R Stabilisatorstang/Stabilizer rod/Diagonalstrebe 135 mm. 
POS	Excel/Pony X2 1/90-1/95
Foraksel/Front axle/Vorneachse	
1	5013407 Venstre/Left/Links Bærearmlenke/Track control arm/Querlenker 
2	5013408 Højre/Right/Rechts Bærearmlenke/Track control arm/Querlenker 
3	5033001 V/H - L/R Styrekugle/Tie rod end/Kugelgelenk 14x1,5 RHT Yderste/Outer/Außen 
4	5033402 V/H - L/R Styrekugle/Tie rod end/Axialgelenk 14x1,5 RHT Inderste/Inner 
5	5043404 V/H - L/R Bærekugle/Ball joint/Radgelenk Nederste/Lower/Unten 













POS	 Getz TB 9/02-
Foraksel/Front axle/Vorneachse	
1	5013411 Venstre/Left/Links Bærearmlenke/Track control arm/Querlenker Nederste/Lower/Unten  1
2	5013412 Højre/Right/Rechs Bærearmlenke/Track control arm/Querlenker Nederste/Lower/Unten  2
3	5033012 V/H - L/R Styrekugle/Tie rod end/Kugelgelenk 14x1,5 RHT Konus/Cone 13,2mm. Yderste/Outer/Außen  3
4	5033419 V/H - L/R Styrekugle/Tie rod end/Axialgelenk 315 mm. 14x1,5 Inderste/Inner
5	5113413 Venstre/Left/Links 198 mm. Stabilisatorstang/Stabilizer rod/Diagonalstrebe
6	5113414 Højre/Right/Rechs 198 mm. Stabilisatorstang/Stabilizer rod/Diagonalstrebe
Bagaksel/Rear axle/Hinterachse	
7	5113403 V/H - L/R Stabilisator bolt/Stabilizer bolt/Stabilisator bolzen  7
POS	 H-1/Starex 6/97-
Foraksel/Front axle/Vorneachse	
1	5033410 V/H - L/R Styrekugle/Tie rod end/Axialgelenk 292 mm. 14x1,5 Inderste/Inner  1
2	5113406 V/H - L/R Stabilisator/Stabilizer/Stabilisator  2
Bagaksel/Rear axle/Hinterachse	
3	5113407 V/H - L/R Stabilisator/Stabilizer/Stabilisator  3







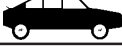



POS	 H100 7/93-3/00
Foraksel/Front axle/Vorneachse	
1	<p>5033001 V/H - L/R Styrekugle/Tie rod end/Kugelgelenk 14x1,5 RHT Yderste/Outer/Außen</p> 
2	<p>5033017 V/H - L/R Styrekugle/Tie rod end/Axialgelenk 14x1,5 RHT Inderste/Inner</p> 
3	<p>5043007 V/H - L/R Bærekugle/Ball joint/Radgelenk Nederste/Lower/Unten</p> 
4	<p>5043011 V/H - L/R Bærekugle/Ball joint/Radgelenk Øverste/Upper/Oben</p> 
POS	 I 30 10/07-
Foraksel/Front axle/Vorneachse	
1	<p>V/H - L/R Bærekugle/Ball joint/Radgelenk</p>
1	<p>Venstre/Left/Links Styrekugle/Tie rod end/Kugelgelenk</p>
1	<p>Højre/Right/Rechs Styrekugle/Tie rod end/Kugelgelenk</p>













POS	 Matrix (FC) 10/01-
Foraksel/Front axle/Vorneachse	
1	<p>5033407 V/H - L/R 14x1,5 RHT Styrekugle/Tie rod end/Kugelgelenk Yderste/Outer/Außen</p>  
2	<p>5043401 V/H - L/R Bærekugle/Ball joint/Radgelenk Nederste/Lower/Unten</p>
3	<p>5113401 Venstre/Left/Links 63 mm. Stabilisator bolt/Stabilizer bolt/Stabilisator bolzen</p> 
4	<p>5113402 Højre/Right/Rechs 63 mm. Stabilisator bolt/Stabilizer bolt/Stabilisator bolzen</p> 
Bagaksel/Rear axle/Hinterachse	
5	<p>5113423 V/H - L/R 70 mm. Stabilisator/Stabilizer/Stabilisator</p> 
POS	

POS	S-Coupe 2/90-5/96			
Foraksel/Front axle/Vorneachse				
1	5013407 Venstre/Left/Links Bærearml/Track control arm/Querlenker			
2	5013408 Højre/Right/Rechs Bærearml/Track control arm/Querlenker			
3	5033001 V/H - L/R Styrekugle/Tie rod end/Kugelgelenk	14x1,5 RHT Yderste/Outer/Außen		
4	5033402 V/H - L/R Styrekugle/Tie rod end/Axialgelenk	14x1,5 RHT Inderste/Inner		
5	5043404 V/H - L/R Bærekugle/Ball joint/Radgelenk	Nederste/Lower/Unten		
6	5093401 Manchetsæt/Boot kit/Manschetten satz			
POS	Santa FE (SM) 8/01-			
Foraksel/Front axle/Vorneachse				
1	5033012 V/H - L/R Styrekugle/Tie rod end/Kugelgelenk	14x1,5 RHT Konus/Cone 13,2mm. Yderste/Outer/Außen		
2	5033418 V/H - L/R Styrekugle/Tie rod end/Axialgelenk	326 mm. 14x1,5 Inderste/Inner		
3	5043409 V/H - L/R Bærekugle/Ball joint/Radgelenk	Nederste/Lower/Unten		
4	5113417 Venstre/Left/Links Stabilisatorstang/Stabilizer rod/Diagonalstrebe	263 mm.		
5	5113418 Højre/Right/Rechs Stabilisatorstang/Stabilizer rod/Diagonalstrebe	263 mm.		
Bagaksel/Rear axle/Hinterachse				
6	5113419 Venstre/Left/Links Stabilisatorstang/Stabilizer rod/Diagonalstrebe	117,5 mm.		
7	5113420 Højre/Right/Rechs Stabilisatorstang/Stabilizer rod/Diagonalstrebe	117,5 mm.		



POS	 Sonata I Y2 9/88-10/93
Foraksel/Front axle/Vorneachse	
1	<p>5033012 V/H - L/R 14x1,5 RHT Konus/Cone 13,2mm. Styrekugle/Tie rod end/Kugelgelenk Yderste/Outer/Außen</p> 
2	<p>5043401 V/H - L/R Bærekugle/Ball joint/Radgelenk Nederste/Lower/Unten</p> 
POS	 Sonata II Y3 5/93-6/98
Foraksel/Front axle/Vorneachse	
1	<p>5033403 V/H - L/R 14x1,5 RHT Styrekugle/Tie rod end/Kugelgelenk Yderste/Outer/Außen</p> 
2	<p>5113408 V/H - L/R 50 mm. Stabilisator/Stabilizer/Stabilisator</p> 
Bagaksel/Rear axle/Hinterachse	
3	<p>5113409 V/H - L/R 65 mm. Stabilisator/Stabilizer/Stabilisator</p> 

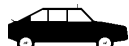

POS	 Sonata III EF 3/98-10/01			
Foraksel/Front axle/Vorneachse				
1	5033415 Venstre/Left/Links Styrekugle/Tie rod end/Kugelgelenk	14x1,5 RHT Yderste/Outer/Außen		
2	5033416 Højre/Right/Rechs Styrekugle/Tie rod end/Kugelgelenk	14x1,5 RHT Yderste/Outer/Außen		
3	5033417 V/H - L/R Styrekugle/Tie rod end/Axialgelenk	14x1,5 RHT Inderste/Inner		
4	5043407 V/H - L/R Bærekugle/Ball joint/Radgelenk	Nederste/Lower/Unten		
5	5043408 V/H - L/R Bærekugle/Ball joint/Radgelenk	Øverste/Upper/Oben		
6	5093612 ZF Manchetsæt/Boot kit/Manschetten satz			
7	5113410 V/H - L/R 1/99 - Stabilisator/Stabilizer/Stabilisator			
Bagaksel/Rear axle/Hinterachse				
8	5033403 V/H - L/R Styrekugle/Tie rod end/Kugelgelenk	14x1,5 RHT Yderste/Outer/Außen		
9	5113411 V/H - L/R - 1/99 Stabilisatorstang/Stabilizer rod/Diagonalstrebe			
POS				
10	5113412 V/H - L/R 1/99 - Stabilisatorstang/Stabilizer rod/Diagonalstrebe			

POS	 Sonata IV 10/01-			
Foraksel/Front axle/Vorneachse				
1	5033415 Venstre/Left/Links Styrekugle/Tie rod end/Kugelgelenk	14x1,5 RHT Yderste/Outer/Außen		
2	5033416 Højre/Right/Rechs Styrekugle/Tie rod end/Kugelgelenk	14x1,5 RHT Yderste/Outer/Außen		
3	5033417 V/H - L/R Styrekugle/Tie rod end/Axialgelenk	14x1,5 RHT Inderste/Inner		
4	5043407 V/H - L/R Bærekugle/Ball joint/Radgelenk	Nederste/Lower/Unten		
5	5043408 V/H - L/R Bærekugle/Ball joint/Radgelenk	Øverste/Upper/Oben		
6	5093612 ZF Manchetsæt/Boot kit/Manschetten satz			
7	5113410 V/H - L/R Stabilisator/Stabilizer/Stabilisator			
Bagaksel/Rear axle/Hinterachse				
8	5113412 V/H - L/R Stabilisatorstang/Stabilizer rod/Diagonalstrebe			
POS	 Trajet (FO) 3/00-			
Foraksel/Front axle/Vorneachse				
1	5033012 V/H - L/R Styrekugle/Tie rod end/Kugelgelenk	14x1,5 RHT Konus/Cone 13,2mm. Yderste/Outer/Außen		
2	5043409 V/H - L/R Bærekugle/Ball joint/Radgelenk	Nederste/Lower/Unten		

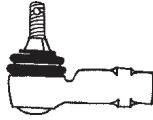
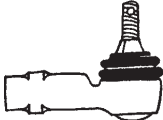
POS	 Tucson (JM) 8/04-			
Foraksel/Front axle/Vorneachse				
1	5033411 Venstre/Left/Links Styrekugle/Tie rod end/Kugelgelenk	16x1,5 RHT Yderste/Outer/Außen		
2	5033412 Højre/Right/Rechs Styrekugle/Tie rod end/Kugelgelenk	16x1,5 RHT Yderste/Outer/Außen		
3	5033413 V/H - L/R Styrekugle/Tie rod end/Axialgelenk	16x1,5 Inderste/Inner		
4	5113415 V/H - L/R Stabilisatorstang/Stabilizer rod/Diagonalstrebe	240 mm.		
5	XXXXXXX V/H - L/R Bærekugle/Ball joint/Radgelenk	Nederste/Lower/Unten		
Bagaksel/Rear axle/Hinterachse				
6	5113416 V/H - L/R 220 mm. Stabilisatorstang/Stabilizer rod/Diagonalstrebe			
POS	 XG 25 12/98-			
Foraksel/Front axle/Vorneachse				
1	5033415 Venstre/Left/Links Styrekugle/Tie rod end/Kugelgelenk	14x1,5 RHT Yderste/Outer/Außen		
2	5033416 Højre/Right/Rechs Styrekugle/Tie rod end/Kugelgelenk	14x1,5 RHT Yderste/Outer/Außen		
3	5033417 V/H - L/R Styrekugle/Tie rod end/Axialgelenk	14x1,5 RHT Inderste/Inner		
4	5043407 V/H - L/R Bærekugle/Ball joint/Radgelenk	Nederste/Lower/Unten		
5	5043408 V/H - L/R Bærekugle/Ball joint/Radgelenk	Øverste/Upper/Oben		



POS	
POS	

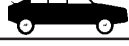
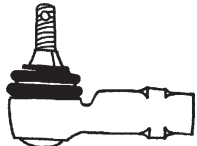
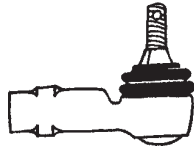

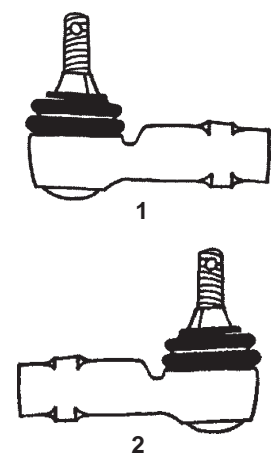
POS	 Campo TFR 4/88-12/90		
		Foraksel/Front axle/Vorneachse	
1	5031410 Venstre/Left/Links Styrekugle/Tie rod end/Kugelgelenk	14x1,5 LHT Konus/Cone 16mm. Yderste/Outer/Außen	
2	5031411 Højre/Right/Rechs Styrekugle/Tie rod end/Kugelgelenk	14x1,5 RHT Konus/Cone 16mm. Yderste/Outer/Außen	
			 <p>1</p>  <p>2</p>
POS	 KB 21/22/26/27 6/81-		
		Foraksel/Front axle/Vorneachse	
1	5031408 U V/H - L/R Styrekugle/Tie rod end/Kugelgelenk	14x1,5 RHT Konus/Cone 13,4mm. Yderste/Outer/Außen	 <p>1</p>

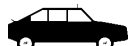







POS	 KB 40/41/42/46/47 4WD 1979-		
Foraksel/Front axle/Vorneachse			
1	5031408 U V/H - L/R Styrekugle/Tie rod end/Kugelgelenk	14x1,5 RHT Konus/Cone 13,4mm. Yderste/Outer/Außen	 1
POS	 Pick-up TFR 4/88-		
Foraksel/Front axle/Vorneachse			
1	5031410 Venstre/Left/Links Styrekugle/Tie rod end/Kugelgelenk	14x1,5 LHT Konus/Cone 16mm. Yderste/Outer/Außen	
2	5031411 Højre/Right/Rechs Styrekugle/Tie rod end/Kugelgelenk	14x1,5 RHT Konus/Cone 16mm. Yderste/Outer/Außen	
			 1
			 2







POS		Trooper (Big horn) UBS 1981-10/86
Foraksel/Front axle/Vorneachse		
1	5031408 U V/H - L/R Styrekugle/Tie rod end/Kugelgelenk	14x1,5 RHT Konus/Cone 13,4mm. Yderste/Outer/Außen  1
POS		Trooper UBS 11/86-1991
Foraksel/Front axle/Vorneachse		
1	5031410 Venstre/Left/Links Styrekugle/Tie rod end/Kugelgelenk	14x1,5 LHT Konus/Cone 16mm. Yderste/Outer/Außen
2	5031411 Højre/Right/Rechs Styrekugle/Tie rod end/Kugelgelenk	14x1,5 RHT Konus/Cone 16mm. Yderste/Outer/Außen
		









POS	
POS	

POS		Grand Cherokee 4.0	1/88-
Foraksel/Front axle/Vorneachse			
1	5004004	Højre/Right/Rechs Styrestang/Steering rod/Spurstange	
2	5044013	V/H - L/R Bærekugle/Ball joint/Radgelenk	Nederste/Lower/Unten
3	5044014	V/H - L/R Bærekugle/Ball joint/Radgelenk	Øverste/Upper/Oben
POS		Grand Cherokee 5.2	1/92- & Grand Cherokee 5.2 1/92-4/99
Foraksel/Front axle/Vorneachse			
1	5004001	Højre/Right/Rechs Styrestang/Steering rod/Spurstange	
2	5034003	Venstre/Left/Links Styrekugle/Tie rod end/Kugelgelenk	Yderste/Outer/Außen
3	5044013	V/H - L/R Bærekugle/Ball joint/Radgelenk	Nederste/Lower/Unten
4	5044014	V/H - L/R Bærekugle/Ball joint/Radgelenk	Øverste/Upper/Oben

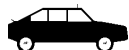
POS		Wrangler 1/88- & Wrangler 1/88-12/96
		Foraksel/Front axle/Vorneachse
1	5004003	Højre/Right/Rechs Styrestang/Steering rod/Spurstange
2	5034008	Venstre/Left/Links Styrekugle/Tie rod end/Kugelgelenk Yderste/Outer/Außen
3	5034009	Højre/Right/Rechs Styrekugle/Tie rod end/Kugelgelenk Yderste/Outer/Außen
4	5044013	V/H - L/R Bærekugle/Ball joint/Radgelenk Nederste/Lower/Unten
5	5044014	V/H - L/R Bærekugle/Ball joint/Radgelenk Øverste/Upper/Oben
POS		

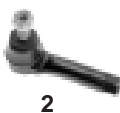
POS	 Besta 2/96-			
Foraksel/Front axle/Vorneachse				
1	5033225 V/H - L/R Styrekugle/Tie rod end/Axialgelenk	14x1,5 RHT Inderste/Inner		1
2	5033236 V/H - L/R Styrekugle/Tie rod end/Kugelgelenk	14x1,5 RHT Yderste/Outer/Außen		2
3	5043213 V/H - L/R Bærekugle/Ball joint/Radgelenk	Øverste/Upper/Oben		3
4	5043214 V/H - L/R Bærekugle/Ball joint/Radgelenk	Nederste/Lower/Unten		4
POS	 Carens I 2/96-7/02			
Foraksel/Front axle/Vorneachse				
1	5033501 V/H - L/R Styrekugle/Tie rod end/Kugelgelenk	14x1,5 RHT Yderste/Outer/Außen		1
2	5043501 V/H - L/R Bærekugle/Ball joint/Radgelenk	Nederste/Lower/Unten		2

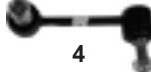



POS	Carenis II 7/02-			
		Foraksel/Front axle/Vorneachse		
1	5113507 Venstre/Left/Links Stabilisator/Stabilizer/Stabilisator			
2	5113508 Højre/Right/Rechs Stabilisator/Stabilizer/Stabilisator			
3	5043501 Bærekugle/Ball joint/Radgelenk			
POS	Carnival 8/99-			
		Foraksel/Front axle/Vorneachse		
1	5013503 Venstre/Left/Links Bærearmlenke/Track control arm/Querlenker			
2	5013504 Højre/Right/Rechs Bærearmlenke/Track control arm/Querlenker			
3	5033510 V/H - L/R Styrekugle/Tie rod end/Axialgelenk	245 mm. 14x1,5		
4	5033511 Venstre/Left/Links Styrekugle/Tie rod end/Kugelgelenk	14x1,5	Yderste/Outer/Außen	
5	5033512 Højre/Right/Rechs Styrekugle/Tie rod end/Kugelgelenk	14x1,5	Yderste/Outer/Außen	
6	5113509 V/H - L/R Stabilisator/Stabilizer/Stabilisator			

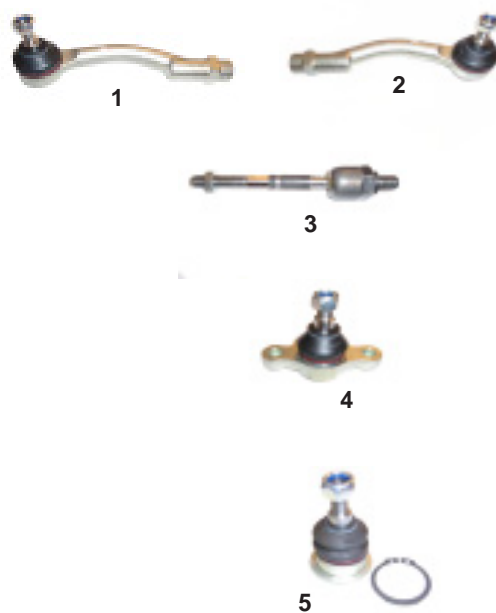





POS	 Cerato 4/04-
Foraksel/Front axle/Vorneachse	
1	5033407 V/H - L/R 14x1,5 RHT Styrekugle/Tie rod end/Kugelgelenk Yderste/Outer/Außen  1
2	5033414 V/H - L/R 14x1,5 RHT Styrekugle/Tie rod end/Axialgelenk Inderste/Inner
3	5043401 V/H - L/R Bærekugle/Ball joint/Radgelenk Nederste/Lower/Unten  3
4	5113517 Venstre/Left/Links Stabilisatorstang/Stabilizer rod/Diagonalstrebe
5	5113518 Højre/Right/Rechs Stabilisatorstang/Stabilizer rod/Diagonalstrebe
Bagaksel/Rear axle/Hinterachse	
6	5113423 V/H - L/R 70 mm. Stabilisator/Stabilizer/Stabilisator
POS	 Clarus 7/96- & Clarus Kombi 5/98-
Foraksel/Front axle/Vorneachse	
1	5033501 V/H - L/R 14x1,5 RHT Styrekugle/Tie rod end/Kugelgelenk  1
2	5033501 V/H - L/R 14x1,5 RHT Styrekugle/Tie rod end/Kugelgelenk Yderste/Outer/Außen  2
3	5113208 Venstre/Left/Links 104 mm. Stabilisatorstang/Stabilizer rod/Diagonalstrebe  3
4	5113209 Højre/Right/Rechs 104 mm. Stabilisatorstang/Stabilizer rod/Diagonalstrebe  4
Bagaksel/Rear axle/Hinterachse	
5	5114506 V/H - L/R 70 mm. Stabilisatorstang/Stabilizer rod/Diagonalstrebe  5









POS	Joice 2/00-
POS	Magentis GD 5/01-
	Foraksel/Front axle/Vorneachse
1	<p>5033415 Venstre/Left/Links 14x1,5 RHT</p> <p>Styrekugle/Tie rod end/Kugelgelenk Yderste/Outer/Außen</p>
2	<p>5033416 Højre/Right/Rechs 14x1,5 RHT</p> <p>Styrekugle/Tie rod end/Kugelgelenk Yderste/Outer/Außen</p>
3	<p>5033417 V/H - L/R 14x1,5 RHT</p> <p>Styrekugle/Tie rod end/Axialgelenk Inderste/Inner</p>
4	<p>5043407 V/H - L/R</p> <p>Bærekugle/Ball joint/Radgelenk Nederste/Lower/Unten</p>
5	<p>5043408 V/H - L/R</p> <p>Bærekugle/Ball joint/Radgelenk Øverste/Upper/Oben</p>









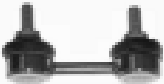







POS		Opirus	9/03-	
------------	--	---------------	--------------	--

POS		Pregio TB	10/97-	
		Foraksel/Front axle/Vorneachse		
1	5033502	V/H - L/R		
	Styrekugle/Tie rod end/Kugelgelenk		Yderste/Outer/Außen	
2	5033503	V/H - L/R		
	Styrekugle/Tie rod end/Axialgelenk		Inderste/Inner	
3	5043502	V/H - L/R		
	Bærekugle/Ball joint/Radgelenk		Nederste/Lower/Unten	
4	5113501	V/H - L/R		
	Stabilisator/Stabilizer/Stabilisator			

POS	Pride 2/96-
Foraksel/Front axle/Vorneachse	
1	<p>5033501 V/H - L/R 14x1,5 RHT  1</p> <p>Styrekugle/Tie rod end/Kugelgelenk Yderste/Outer/Außen</p>
POS	Rio 8/00-
Foraksel/Front axle/Vorneachse	
1	<p>5013501 Venstre/Left/Links  1 2</p> <p>Bærearml/Track control arm/Querlenker Nederste/Lower/Unten</p>
2	<p>5013502 Højre/Right/Rechs  3</p> <p>Bærearml/Track control arm/Querlenker Nederste/Lower/Unten</p>
3	<p>5033509 V/H - L/R  3</p> <p>Styrekugle/Tie rod end/Kugelgelenk Yderste/Outer/Außen</p>
4	<p>5113505 Venstre/Left/Links  4</p> <p>Stabilisatorstang/Stabilizer rod/Diagonalstrebe</p>
5	<p>5113506 Højre/Right/Rechs  5</p> <p>Stabilisatorstang/Stabilizer rod/Diagonalstrebe</p>









POS	 Rio II 3/05-				
		Foraksel/Front axle/Vorneachse			
1	XXXXXXX Venstre/Left/Links Stabilisatorstang/Stabilizer rod/Diagonalstrebe				
2	XXXXXXX Højre/Right/Rechs Stabilisatorstang/Stabilizer rod/Diagonalstrebe				
POS	 Sephia FA 9/93-				
		Foraksel/Front axle/Vorneachse			
1	5033501 V/H - L/R - 4/1997 Styrekugle/Tie rod end/Kugelgelenk	14x1,5 RHT Yderste/Outer/Außen			
2	5033504 V/H - L/R - 4/1997 Styrekugle/Tie rod end/Axialgelenk	Inderste/Inner			
3	5033513 V/H - L/R 5/1997 - Styrekugle/Tie rod end/Kugelgelenk	14x1,5 RHT Yderste/Outer/Außen			
4	5033514 V/H - L/R 5/1997 - Styrekugle/Tie rod end/Axialgelenk	293 mm. 14x1,5 Inderste/Inner			
5	5043503 V/H - L/R - 4/1997 Bærekugle/Ball joint/Radgelenk	Konus/Cone 16mm. Nederste/Lower/Unten			
6	5043504 V/H - L/R 5/1997 - Bærekugle/Ball joint/Radgelenk	Konus/Cone 18mm. Nederste/Lower/Unten			
7	5113502 V/H - L/R 85 mm. Stabilisator/Stabilizer/Stabilisator				

POS				
8	XXXXXXXX V/H - L/R 5/1997 -	Bærekugle/Ball joint/Radgelenk	Konus/Cone 18mm. Nederste/Lower/Unten	
Bagaksel/Rear axle/Hinterachse				
9	5113503 V/H - L/R	Stabilisator/Stabilizer/Stabilisator		 9
POS		Shuma FB 3/96-		
Foraksel/Front axle/Vorneachse				
1	5033513 V/H - L/R	Styrekugle/Tie rod end/Kugelgelenk	14x1,5 RHT Yderste/Outer/Außen	 1
2	5033514 V/H - L/R 293 mm.	Styrekugle/Tie rod end/Axialgelenk	14x1,5 Inderste/Inner	 2
3	5043504 V/H - L/R	Bærekugle/Ball joint/Radgelenk	Konus/Cone 18mm. Nederste/Lower/Unten	 3
4	5113502 V/H - L/R 85 mm.	Stabilisator/Stabilizer/Stabilisator		 4
5	XXXXXXXX V/H - L/R	Bærekugle/Ball joint/Radgelenk	Konus/Cone 18mm. Nederste/Lower/Unten	
Bagaksel/Rear axle/Hinterachse				
6	5113503 V/H - L/R	Stabilisator/Stabilizer/Stabilisator		 6

POS	Shuma II FB 5/01-			
		Foraksel/Front axle/Vorneachse		
1	5033513 V/H - L/R Styrekgule/Tie rod end/Kugelgelenk	14x1,5 RHT Yderste/Outer/Außen		
2	5033514 V/H - L/R 293 mm. Styrekgule/Tie rod end/Axialgelenk	14x1,5 Inderste/Inner		
3	5043504 V/H - L/R Bærekugle/Ball joint/Radgelenk	Konus/Cone 18mm. Nederste/Lower/Unten		
4	5113507 Venstre/Left/Links Stabilisator/Stabilizer/Stabilisator			
5	5113508 Højre/Right/Rechs Stabilisator/Stabilizer/Stabilisator			
6	XXXXXXX V/H - L/R Bærekugle/Ball joint/Radgelenk	Konus/Cone 18mm. Nederste/Lower/Unten		
POS	Sorento (JC) 8/02-			
		Foraksel/Front axle/Vorneachse		
1	5013505 Venstre/Left/Links Bærearmlenke/Track control arm/Querlenker	Nederste/Lower/Unten		
2	5013506 Højre/Right/Rechs Bærearmlenke/Track control arm/Querlenker	Nederste/Lower/Unten		
3	5033505 Venstre/Left/Links Styrekgule/Tie rod end/Kugelgelenk	Yderste/Outer/Außen		
4	5033506 Højre/Right/Rechs Styrekgule/Tie rod end/Kugelgelenk	Yderste/Outer/Außen		
5	5033507 Venstre/Left/Links Styrekgule/Tie rod end/Axialgelenk	Inderste/Inner		
6	5033508 Højre/Right/Rechs Styrekgule/Tie rod end/Axialgelenk	Inderste/Inner		
7	5043505 V/H - L/R Bærekugle/Ball joint/Radgelenk	Nederste/Lower/Unten		

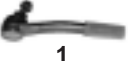



POS			
		Foraksel/Front axle/Vorneachse	
8	5113504 V/H - L/R - 2/04 Stabilisator bolt/Stabilizer bolt/Stabilisator bolzen		
9	5113511 Venstre/Left/Links 2/04 - Stabilisator/Stabilizer/Stabilisator		
10	5113512 Højre/Right/Rechs 2/04 - Stabilisator/Stabilizer/Stabilisator		
		Bagaksel/Rear axle/Hinterachse	
11	5113513 Venstre/Left/Links Stabilisator/Stabilizer/Stabilisator		
12	5113514 Højre/Right/Rechs Stabilisator/Stabilizer/Stabilisator		
POS		Sportage 9/04-	
		Foraksel/Front axle/Vorneachse	
1	5033411 Venstre/Left/Links Styrekugle/Tie rod end/Kugelgelenk	16x1,5 RHT Yderste/Outer/Außen	
2	5033412 Højre/Right/Rechs Styrekugle/Tie rod end/Kugelgelenk	16x1,5 RHT Yderste/Outer/Außen	
3	5033413 V/H - L/R Styrekugle/Tie rod end/Axialgelenk	16x1,5 Inderste/Inner	
4	5113415 V/H - L/R Stabilisatorstang/Stabilizer rod/Diagonalstrebe	240 mm.	
5	XXXXXXX V/H - L/R Bærekugle/Ball joint/Radgelenk	Nederste/Lower/Unten	
		Bagaksel/Rear axle/Hinterachse	
6	5113416 V/H - L/R Stabilisatorstang/Stabilizer rod/Diagonalstrebe	220 mm.	







POS	110/111/112 1/95-		
Foraksel/Front axle/Vorneachse			
1	5032367 Venstre/Left/Links Styrekugle/Tie rod end/Kugelgelenk	18x1,5 LHT Konus/Cone 12,5mm. Yderste/Outer/Außen	
2	5032368 Højre/Right/Rechs Styrekugle/Tie rod end/Kugelgelenk	18x1,5 LHT Konus/Cone 12,5mm. Yderste/Outer/Außen	
POS	1200/1300/1500/1600 1972-1/87		
Foraksel/Front axle/Vorneachse			
1	5002305 U Midt/Center/Mitte Styrestang/Steering rod/Spurstange		
2	5012329 Venstre/Left/Links Bæream/Track control arm/Querlenker	Øverste/Upper/Oben	
3	5012330 Højre/Right/Rechs Bæream/Track control arm/Querlenker	Øverste/Upper/Oben	
4	5012331 Venstre/Left/Links Bæream/Track control arm/Querlenker	Nederste/Lower/Unten	
5	5012332 Højre/Right/Rechs Bæream/Track control arm/Querlenker	Nederste/Lower/Unten	
6	5032315 V/H - L/R 16x1 LHT Styrekugle/Tie rod end/Kugelgelenk	Yderste/Outer/Außen	
7	5032324 Venstre/Left/Links Styrekugle/Tie rod end/Axialgelenk	16x1,0 LHT Konus/Cone 15mm. Inderste/Inner	
8	5032325 Højre/Right/Rechs Styrekugle/Tie rod end/Axialgelenk	16x1,0 LHT Konus/Cone 15mm. Inderste/Inner	
9	5042307 V/H - L/R Bærekugle/Ball joint/Radgelenk	Øverste/Upper/Oben	
10	5042308 V/H - L/R Bærekugle/Ball joint/Radgelenk	Nederste/Lower/Unten	

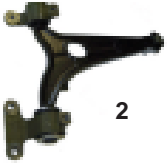









POS	 Niva 12/76-1985			
		Foraksel/Front axle/Vorneachse		
1	5032315 V/H - L/R Styrekugle/Tie rod end/Kugelgelenk	16x1 LHT Yderste/Outer/Außen		1
2	5032327 U V/H - L/R Styrekugle/Tie rod end/Kugelgelenk	16x1,0 LHT Konus/Cone 15mm. Inderste/Inner		3
3	5042307 V/H - L/R Bærekugle/Ball joint/Radgelenk	Øverste/Upper/Oben		4
4	5042307 V/H - L/R Bærekugle/Ball joint/Radgelenk	Nederste/Lower/Unten		
POS	 Samara 3/85-			
		Foraksel/Front axle/Vorneachse		
1	5032335 Venstre/Left/Links Styrekugle/Tie rod end/Kugelgelenk	18x1,5 LHT Konus/Cone 12,5mm. Yderste/Outer/Außen		1
2	5032336 Højre/Right/Rechs Styrekugle/Tie rod end/Kugelgelenk	18x1,5 LHT Konus/Cone 12,5mm. Yderste/Outer/Außen		2
3	5042312 V/H - L/R Bærekugle/Ball joint/Radgelenk	Nederste/Lower/Unten		3
4	5092312 Manchetsæt/Boot kit/Manschetten satz			4



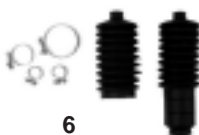





POS	A 112 1970-12/86		
1	5012301 V/H - L/R Bæream/Track control arm/Querlenker		
2	5022301 U - 10/82 Tandstang/Steering rack/Zahnstange		
3	5032303 V/H - L/R 11/82 - Styrekugle/Tie rod end/Kugelgelenk	12x1,5 RHT Yderste/Outer/Außen	
4	5092301 Manchetsæt/Boot kit/Manschetten satz		
POS	Dedra 4/89-7/99	Foraksel/Front axle/Vorneachse	
1	5011001 Venstre/Left/Links TD Bæream/Track control arm/Querlenker		
2	5011002 Højre/Right/Rechs TD Bæream/Track control arm/Querlenker		
3	5012317 Venstre/Left/Links - 6/90 Bæream/Track control arm/Querlenker	Konus/Cone 15mm.	
4	5012318 Højre/Right/Rechs - 6/90 Bæream/Track control arm/Querlenker	Konus/Cone 15mm.	
5	5012319 Venstre/Left/Links Bæream/Track control arm/Querlenker	Ex. TD 7/90 - Konus/Cone 17mm.	
6	5012320 Højre/Right/Rechs Bæream/Track control arm/Querlenker	Ex. TD 7/90 - Konus/Cone 17mm.	
7	5032333 Venstre/Left/Links Styrekugle/Tie rod end/Kugelgelenk	12x1,5 RHT Yderste/Outer/Außen	
8	5032334 Højre/Right/Rechs Styrekugle/Tie rod end/Kugelgelenk	12x1,5 RHT Yderste/Outer/Außen	





POS	Dedra 4/89-7/99			
Foraksel/Front axle/Vorneachse				
9	5032343 V/H - L/R (**) Styrekugle/Tie rod end/Axialgelenk	12x1,5 RHT Inderste/Inner		9
10	5092310 Manchetsæt/Boot kit/Manschetten satz			10
11	5112301 V/H - L/R - 12/97 Stabilisator/Stabilizer/Stabilisator	Ø12mm. 100 mm.		11
12	5112307 V/H - L/R 1/98 - Stabilisator/Stabilizer/Stabilisator	275 mm.		12
				(**) Med Servo Styring With Power Steering Mit Servolenkung
POS	Delta 6/93-8/99			
Foraksel/Front axle/Vorneachse				
1	5012319 Venstre/Left/Links Bærearmlenke/Track control arm/Querlenker	Konus/Cone 17mm. Nederste/Lower/Unten		1
2	5012320 Højre/Right/Rechs Bærearmlenke/Track control arm/Querlenker	Konus/Cone 17mm. Nederste/Lower/Unten		2
3	5032333 Venstre/Left/Links Styrekugle/Tie rod end/Kugelgelenk	12x1,5 RHT Yderste/Outer/Außen		3
4	5032334 Højre/Right/Rechs Styrekugle/Tie rod end/Kugelgelenk	12x1,5 RHT Yderste/Outer/Außen		4
5	5032343 V/H - L/R (**) Styrekugle/Tie rod end/Axialgelenk	12x1,5 RHT Inderste/Inner		5
6	5112301 V/H - L/R Stabilisator/Stabilizer/Stabilisator	Ø12mm. 100 mm.		6
				(**) Med Servo Styring With Power Steering Mit Servolenkung







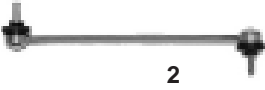



POS	 Kappa 8/94-
Foraksel/Front axle/Vorneachse	
1	5032330 V/H - L/R Styrekugle/Tie rod end/Kugelgelenk 14x1,5 RHT Yderste/Outer/Außen  1
2	5042318 V/H - L/R Bærekugle/Ball joint/Radgelenk Nederste/Lower/Unten  2
POS	 Phedra (179) 9/02-
Foraksel/Front axle/Vorneachse	
1	5011939 Venstre/Left/Links Bæream/Track control arm/Querlenker  1
2	5011940 Højre/Right/Rechs Bæream/Track control arm/Querlenker  2
3	XXXXXXXX V/H - L/R Styrekugle/Tie rod end/Axialgelenk Inderste/Inner
4	XXXXXXXX V/H - L/R Styrekugle/Tie rod end/Kugelgelenk 14x1,5 Konus/Cone 13,5mm. Yderste/Outer/Außen
5	XXXXXXXX V/H - L/R Stabilisatorstang/Stabilizer rod/Diagonalstrebe 262,5 mm.

POS	Musa 10/04-			
		Foraksel/Front axle/Vorneachse		
1	5012367 Venstre/Left/Links Bærearml/Track control arm/Querlenker	Nederste/Lower/Unten		
2	5012368 Højre/Right/Rechs Bærearml/Track control arm/Querlenker	Nederste/Lower/Unten		
3	5032378 V/H - L/R Styrekugle/Tie rod end/Axialgelenk	258 mm. 14x1,5 RHT Inderste/Inner		
4	5032379 V/H - L/R Styrekugle/Tie rod end/Kugelgelenk	14x1,5 RHT Yderste/Outer/Außen		 3  4
POS	Thema (834) 3/86-7/94			
		Foraksel/Front axle/Vorneachse		
1	5012313 Venstre/Left/Links Bærearml/Track control arm/Querlenker		 1	 2
2	5012314 Højre/Right/Rechs Bærearml/Track control arm/Querlenker			
3	5032330 V/H - L/R (**) Styrekugle/Tie rod end/Kugelgelenk	14x1,5 RHT Yderste/Outer/Außen	 3	 4
4	5032331 V/H - L/R (**) Styrekugle/Tie rod end/Axialgelenk	14x1,5 RHT Inderste/Inner		
5	5042311 V/H - L/R Bærekugle/Ball joint/Radgelenk	Ø13mm. 12x1,25 RHT Nederste/Lower/Unten	 5	
				(**) Med Servo Styling With Power Steering Mit Servolenkung









POS					
		Y 10 3/85-12/95			
		Foraksel/Front axle/Vorneachse			
1		5012307 U V/H - L/R Bæream/Track control arm/Querlenker			
2		5032308 V/H - L/R Styrekugle/Tie rod end/Kugelgelenk	12x1,5 RHT Yderste/Outer/Außen		2
3		5042303 V/H - L/R Bærekugle/Ball joint/Radgelenk	Nederste/Lower/Unten		3
4		5042313 V/H - L/R Bærekugle/Ball joint/Radgelenk	Nederste/Lower/Unten		4
5		5042314 V/H - L/R Bærekugle komplet/Complete ball joint/ Radgelenk komplett	Nederste/Lower/Unten		5
6		5092301 Manchetsæt/Boot kit/Manschetten satz			6
POS		Y 5/95-			
		Foraksel/Front axle/Vorneachse			
1		5012321 Venstre/Left/Links Bæream/Track control arm/Querlenker	Nederste/Lower/Unten		1
2		5012322 Højre/Right/Rechs Bæream/Track control arm/Querlenker	Nederste/Lower/Unten		2
3		5032344 V/H - L/R Styrekugle/Tie rod end/Kugelgelenk	12x1,5 RHT Yderste/Outer/Außen		3
4		5032346 V/H - L/R Styrekugle/Tie rod end/Axialgelenk	12x1,5 RHT Inderste/Inner		4

POS	 Ypsilon 10/03-
Foraksel/Front axle/Vorneachse	
1	5012367 Venstre/Left/Links Bæream/Track control arm/Querlenker Nederste/Lower/Unten
2	5012368 Højre/Right/Rechs Bæream/Track control arm/Querlenker Nederste/Lower/Unten
3	5032380 V/H - L/R 259 mm. 12x1,5 Styrekugle/Tie rod end/Axialgelenk Inderste/Inner
4	5032381 V/H - L/R 12x1,5 RHT Styrekugle/Tie rod end/Kugelgelenk Yderste/Outer/Außen
POS	 Zeta 5/95-9/02
Foraksel/Front axle/Vorneachse	
1	5011905 Venstre/Left/Links Støbejern/Cast iron/Grauguß Bæream/Track control arm/Querlenker  1  2
2	5011906 Højre/Right/Rechs Støbejern/Cast iron/Grauguß Bæream/Track control arm/Querlenker
3	5031916 V/H - L/R 14x1,5 RHT Konus/Cone 15mm.  3 Styrekugle/Tie rod end/Kugelgelenk Yderste/Outer/Außen
4	5031917 V/H - L/R M14x1,5 RHT  4 Styrekugle/Tie rod end/Axialgelenk Inderste/Inner
5	5092314 Manchetsæt/Boot kit/Manschetten satz  5
6	5112302 V/H - L/R Ø12mm. 120 mm.  6 Stabilisator/Stabilizer/Stabilisator













POS		2	4/03		
Foraksel/Front axle/Vorneachse					
1	5032566	V/H - L/R	278 mm. 14x1,5	Inderste/Inner	
2	5112520	V/H - L/R	240 mm.		
Foraksel/Front axle/Vorneachse					
POS		121 DA	10/87-10/90		
Foraksel/Front axle/Vorneachse					
1	5033222	V/H - L/R	12x1,25 RHT	Yderste/Outer/Außen	

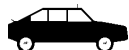





POS	121 DB 11/90-3/96		
Foraksel/Front axle/Vorneachse			
1	5033229 V/H - L/R Styrekugle/Tie rod end/Kugelgelenk	12x1,25 RHT Yderste/Outer/Außen	 1
POS	121 JA/JB 3/96-		
Foraksel/Front axle/Vorneachse			
1	5012527 Venstre/Left/Links Bæream/Track control arm/Querlenker		 1
2	5012528 Højre/Right/Rechs Bæream/Track control arm/Querlenker		 2
3	5032526 Venstre/Left/Links Styrekugle/Tie rod end/Kugelgelenk	12x1,5 RHT Yderste/Outer/Außen	 3
4	5032527 Højre/Right/Rechs Styrekugle/Tie rod end/Kugelgelenk	12x1,5 RHT Yderste/Outer/Außen	 4
5	5042516 V/H - L/R Bærekugle/Ball joint/Radgelenk	Nederste/Lower/Unten	 5
6	5092519 (*) Manchetsæt/Boot kit/Manschetten satz		 6
7	5092522 (**) Manchetsæt/Boot kit/Manschetten satz		 7
8	5102512 For/Front/Vorne Bøsning/Bushing/Buchsen	V/H - L/R	 8
9	5102513 Bag/Rear/Hinten Bøsning/Bushing/Buchsen	V/H - L/R	 9
			(*) Uden Servo Styring Without Power Steering Ohne Servolenkung
			(**) Med Servo Styring With Power Steering Mit Servolenkung











POS	121 JA/JB 3/96-					
		Foraksel/Front axle/Vorneachse				
10	5112503 V/H - L/R	240 mm.			10	
		Stabilisatorstang/Stabilizer rod/Diagonalstrebe				
		Bagaksel/Rear axle/Hinterachse				
11	5113222	V/H - L/R			11	
		Stabilisator bolt/Stabilizer bolt/Stabilisator bolzen				
POS	3 10/03-					
		Foraksel/Front axle/Vorneachse				
1	5013225 Venstre/Left/Links				1	
		Bæream/Track control arm/Querlenker				
2	5013226 Højre/Right/Rechs				2	
		Bæream/Track control arm/Querlenker				
3	5033238 V/H - L/R				3	
		Styrekugle/Tie rod end/Axialgelenk	Inderste/Inner			
4	5033239 Venstre/Left/Links				4	
		Styrekugle/Tie rod end/Kugelgelenk	Yderste/Outer/Außen			
5	5033240 Højre/Right/Rechs				5	
		Styrekugle/Tie rod end/Kugelgelenk	Yderste/Outer/Außen			
6	5042525 V/H - L/R					
		Bærekugle/Ball joint/Radgelenk	Konus/Cone 18mm. Nederste/Lower/Unten			
7	5113218 V/H - L/R	307 mm.			7	
		Stabilisator bolt/Stabilizer bolt/Stabilisator bolzen				
		Bagaksel/Rear axle/Hinterachse				
8	5012552 V/H - L/R				8	
		Bæream/Track control arm/Querlenker	Nederste/Lower/Unten			
9	5112522 V/H - L/R	99 mm.			9	
		Stabilisator bolt/Stabilizer bolt/Stabilisator bolzen				

POS	323 I FA4 11/76-5/80 & 323 I Station Wagon 5/78-5/86
Foraksel/Front axle/Vorneachse	
1	<p>5033202 U V/H - L/R Styrekugle/Tie rod end/Kugelgelenk 14x1,5 LHT Konus/Cone 12,5mm. Yderste/Outer/Außen</p>  1
2	<p>5043201 U V/H - L/R Bærekugle/Ball joint/Radgelenk Nederste/Lower/Unten</p>  2
3	<p>5113201 V/H - L/R Stabilisator bolt/Stabilizer bolt/Stabilisator bolzen 100 mm.</p>  3
POS	323 II BD 8/80-12/85
Foraksel/Front axle/Vorneachse	
1	<p>5033203 U Venstre/Left/Links Styrekugle/Tie rod end/Kugelgelenk 12x1,25 RHT Konus/Cone 12,5mm. Yderste/Outer/Außen</p>  1
2	<p>5033204 U Højre/Right/Rechs Styrekugle/Tie rod end/Axialgelenk 12x1,25 RHT Konus/Cone 12,5mm. Yderste/Outer/Außen</p>  2
3	<p>5033219 U V/H - L/R (*) Styrekugle/Tie rod end/Axialgelenk 12x1,25/14x1,5 RHT Inderste/Inner</p>  3
4	<p>5043202 V/H - L/R Bærekugle/Ball joint/Radgelenk Nederste/Lower/Unten</p>  4
5	<p>5113201 V/H - L/R Stabilisator bolt/Stabilizer bolt/Stabilisator bolzen 100 mm.</p>  5
	<p>(*) Uden Servo Styring Without Power Steering Ohne Servolenkung</p>

POS	323 III BF 5/85-10/89 & 323 III BW 11/85-3/93				
Foraksel/Front axle/Vorneachse					
1	5013209 Venstre/Left/Links Bærearmlenke/Track control arm/Querlenker	Nederste/Lower/Unten			
2	5013210 Højre/Right/Rechs Bærearmlenke/Track control arm/Querlenker	Nederste/Lower/Unten			
3	5033222 V/H - L/R Styrekugle/Tie rod end/Kugelgelenk	12x1,25 RHT Yderste/Outer/Außen			
4	5033223 V/H - L/R (*) Styrekugle/Tie rod end/Axialgelenk	12x1,25 RHT Inderste/Inner			
5	5043212 V/H - L/R Bærekugle/Ball joint/Radgelenk	Nederste/Lower/Unten			
6	5093202 Manchetsæt/Boot kit/Manschetten satz				
7	5113201 V/H - L/R Stabilisator bolt/Stabilizer bolt/Stabilisator bolzen	100 mm.			
Bagaksel/Rear axle/Hinterachse					
8	5013213 Venstre/Left/Links Bærearmlenke/Track control arm/Querlenker				
9	5013214 Højre/Right/Rechs Bærearmlenke/Track control arm/Querlenker				
10	5113202 V/H - L/R Stabilisator bolt/Stabilizer bolt/Stabilisator bolzen	120 mm.			
					(*) Uden Servo Styling Without Power Steering Ohne Servolenkung
POS	323 IV BG 9/89-10/94				
Foraksel/Front axle/Vorneachse					
1	5013211 Venstre/Left/Links Bærearmlenke/Track control arm/Querlenker	Nederste/Lower/Unten			
2	5013212 Højre/Right/Rechs Bærearmlenke/Track control arm/Querlenker	Nederste/Lower/U			
3	5033226 U V/H - L/R - 12/91 (*) Styrekugle/Tie rod end/Axialgelenk	12x1,25 RHT Inderste/Inner			
4	5033227 Venstre/Left/Links (**) Styrekugle/Tie rod end/Axialgelenk	12x1,25 RHT Inderste/Inner			
5	5033228 Højre/Right/Rechs (**) Styrekugle/Tie rod end/Axialgelenk	12x1,25 RHT Inderste/Inner			
6	5033229 V/H - L/R Styrekugle/Tie rod end/Kugelgelenk	12x1,25 RHT Yderste/Outer/Außen			
7	5043215 V/H - L/R Bærekugle/Ball joint/Radgelenk	CH. - 1630911 Konus/Cone 16mm. Nederste/Lower/Unten			
8	5043219 V/H - L/R Bærekugle/Ball joint/Radgelenk	CH. 1630912- Konus/Cone 18mm. Nederste/Lower/Unten			
9	5113207 V/H - L/R Stabilisator bolt/Stabilizer bolt/Stabilisator bolzen	CH. - 1630911 110 mm.			
					(*) Uden Servo Styling Without Power Steering Ohne Servolenkung
					(**) Med Servo Styling With Power Steering Mit Servolenkung

POS	 323 IV BG 9/89-10/94
Bagaksel/Rear axle/Hinterachse	
10	5013219 Venstre/Left/Links  10 Bærearml/Track control arm/Querlenke
11	5013220 Højre/Right/Rechs  11 Bærearml/Track control arm/Querlenker
12	5113202 V/H - L/R CH. - 1630911 120 mm.  12 Stabilisator bolt/Stabilizer bolt/Stabilisator bolzen
POS	 323 V BA 8/94-9/98
Foraksel/Front axle/Vorneachse	
1	5013221 Venstre/Left/Links  1 Bærearml/Track control arm/Querlenker
2	5013222 Højre/Right/Rechs  2 Bærearml/Track control arm/Querlenker
3	5033229 V/H - L/R 12x1,25 RHT  3 Styrekugle/Tie rod end/Kugelgelenk Yderste/Outer/Außen
4	5043219 V/H - L/R Konus/Cone 18mm.  4 Bærekugle/Ball joint/Radgelenk Nederste/Lower/Unten
5	5113208 Venstre/Left/Links 104 mm.  5 Stabilisatorstang/Stabilizer rod/Diagonalstrebe
6	5113209 Højre/Right/Rechs 104 mm.  6 Stabilisatorstang/Stabilizer rod/Diagonalstrebe
Bagaksel/Rear axle/Hinterachse	
7	5113210 V/H - L/R 250 mm.  7 Stabilisatorstang/Stabilizer rod/Diagonalstrebe







POS	 323 VI BJ 9/98-
Foraksel/Front axle/Vorneachse	
1	<p>5033235 V/H - L/R 14x1,5 RHT Styrekugle/Tie rod end/Kugelgelenk Yderste/Outer/Außen</p>  1
2	<p>5113212 V/H - L/R CH. - JMZBJ304194 - 8/00 190 mm. Stabilisatorstang/Stabilizer rod/Diagonalstrebe</p>  2
3	<p>5113217 V/H - L/R CH. JMZBJ304195- 8/00 - 266 mm. Stabilisatorstang/Stabilizer rod/Diagonalstrebe</p>
Bagaksel/Rear axle/Hinterachse	
4	<p>5113213 V/H - L/R CH. - JMZBJ304194 - 8/00 193 mm. Stabilisatorstang/Stabilizer rod/Diagonalstrebe</p>  4
5	<p>5113227 V/H - L/R CH. JMZBJ304195- 8/00 - 160 mm. Stabilisatorstang/Stabilizer rod/Diagonalstrebe</p>
POS	 5 (CR19) 3/05-
Bagaksel/Rear axle/Hinterachse	
1	<p>5012552 V/H - L/R Bærearmlenker/Track control arm/Querlenker Nederste/Lower/Unten</p>  1





POS	 6 6/02-			
Foraksel/Front axle/Vorneachse				
1	5013223 V/H - L/R Bærearml/Track control arm/Querlenker			 1
2	5033241 Venstre/Left/Links Styrekugle/Tie rod end/Kugelgelenk	Yderste/Outer/Außen		 2
3	5033242 Højre/Right/Rechs Styrekugle/Tie rod end/Kugelgelenk	Yderste/Outer/Außen		 3
4	5033243 V/H - L/R Styrekugle/Tie rod end/Axialgelenk	Inderste/Inner		 4
5	5113219 Venstre/Left/Links 155 mm. Stabilisatorstang/Stabilizer rod/Diagonalstrebe			 5
6	5113220 Højre/Right/Rechs 155 mm. Stabilisatorstang/Stabilizer rod/Diagonalstrebe			 6
Bagaksel/Rear axle/Hinterachse				
7	5113221 V/H - L/R 78 mm. Stabilisator bolt/Stabilizer bolt/Stabilisator bolzen			 7
POS	 626 I CB 9/78-5/82			
Foraksel/Front axle/Vorneachse				
1	5033202 U V/H - L/R Styrekugle/Tie rod end/Kugelgelenk	14x1,5 LHT Konus/Cone 12,5mm.	Yderste/Outer/Außen	 1







POS	626 II GC 11/82-1987		
Foraksel/Front axle/Vorneachse			
1	5013205 U Venstre/Left/Links Bæream/Track control arm/Querlenker		1
2	5013206 U Højre/Right/Rechs Bæream/Track control arm/Querlenker		2
3	5033208 V/H - L/R Styrekugle/Tie rod end/Kugelgelenk	14x1,6 RHT Yderste/Outer/Außen	
4	5033217 U Venstre/Left/Links (*) Styrekugle/Tie rod end/Axialgelenk	14x1,5 RHT Inderste/Inner	
5	5033218 U Højre/Right/Rechs (*) Styrekugle/Tie rod end/Axialgelenk	14x1,5 RHT Inderste/Inner	
6	5043204 V/H - L/R Bærekugle/Ball joint/Radgelenk	Nederste/Lower/Unten	
7	5093201 U (*) Manchetsæt/Boot kit/Manschetten satz		7
8	5093202 (**) Manchetsæt/Boot kit/Manschetten satz		8
9	5113203 V/H - L/R Stabilisator bolt/Stabilizer bolt/Stabilisator bolzen	190 mm.	
9			
POS			
Bagaksel/Rear axle/Hinterachse			
10	5113204 V/H - L/R Stabilisator bolt/Stabilizer bolt/Stabilisator bolzen	130 mm.	
			10
		(*)	Uden Servo Styring Without Power Steering Ohne Servolenkung
		(**)	Med Servo Styring With Power Steering Mit Servolenkung







POS	626 III GD 5/87-5/92				
Foraksel/Front axle/Vorneachse					
1	5013207 Venstre/Left/Links Bærearml/Track control arm/Querlenker				
2	5013208 Højre/Right/Rechs Bærearml/Track control arm/Querlenker				
3	5033208 V/H - L/R Styrekugle/Tie rod end/Kugelgelenk	14x1,6 RHT CH. - 561648 Yderste/Outer/Außen			
4	5033230 V/H - L/R (**) Styrekugle/Tie rod end/Axialgelenk	14x1,5 RHT Inderste/Inner			
5	5033235 V/H - L/R Styrekugle/Tie rod end/Kugelgelenk	14x1,5 RHT CH. 561649- Yderste/Outer/Außen			
6	5043204 V/H - L/R Bærekugle/Ball joint/Radgelenk	Nederste/Lower/Unten			
7	5113205 V/H - L/R Stabilisator bolt/Stabilizer bolt/Stabilisator bolzen	170 mm.			
Bagaksel/Rear axle/Hinterachse					
8	5113206 V/H - L/R Stabilisator bolt/Stabilizer bolt/Stabilisator bolzen	130 mm.			
					(**) Med Servo Styring With Power Steering Mit Servolenkung
POS	626 Kombi III GV 9/87-9/97				
Foraksel/Front axle/Vorneachse					
1	5033208 V/H - L/R - 7/89 Styrekugle/Tie rod end/Kugelgelenk	14x1,6 RHT Yderste/Outer/Außen			
2	5033235 V/H - L/R 8/89 - Styrekugle/Tie rod end/Kugelgelenk	14x1,5 RHT Yderste/Outer/Außen			
3	5033230 V/H - L/R (**) Styrekugle/Tie rod end/Axialgelenk	14x1,5 RHT Inderste/Inner			
4	5043204 V/H - L/R (**) Bærekugle/Ball joint/Radgelenk	Nederste/Lower/Unten			
5	5093202 (**) Manchetsæt/Boot kit/Manschetten satz				
6	5113205 V/H - L/R Stabilisator bolt/Stabilizer bolt/Stabilisator bolzen	170 mm.			
Bagaksel/Rear axle/Hinterachse					
7	5113206 V/H - L/R Stabilisator bolt/Stabilizer bolt/Stabilisator bolzen	130 mm.			
					(**) Med Servo Styring With Power Steering Mit Servolenkung

POS	626 IV GE 8/91-4/97				
Foraksel/Front axle/Vorneachse					
1	5013216 Venstre/Left/Links Bærearmlenke/Track control arm/Querlenker	Nederste/Lower/Unten			
2	5013217 Højre/Right/Rechs Bærearmlenke/Track control arm/Querlenker	Nederste/Lower/Unten			
3	5033235 V/H - L/R Styrekugle/Tie rod end/Kugelgelenk	14x1,5 RHT Yderste/Outer/Außen			
4	5043204 V/H - L/R Bærekugle/Ball joint/Radgelenk	Nederste/Lower/Unten			
5	5093203 Manchetsæt/Boot kit/Manschetten satz				
6	5113208 Venstre/Left/Links 104 mm. Stabilisatorstang/Stabilizer rod/Diagonalstrebe				
7	5113209 Højre/Right/Rechs 104 mm. Stabilisatorstang/Stabilizer rod/Diagonalstrebe				
Bagaksel/Rear axle/Hinterachse					
8	5113211 V/H - L/R 88 mm. Stabilisatorstang/Stabilizer rod/Diagonalstrebe				
POS	626 V GF 5/97-				
Foraksel/Front axle/Vorneachse					
1	5013227 Venstre/Left/Links Bærearmlenke/Track control arm/Querlenker	Nederste/Lower/Unten			
2	5013228 Højre/Right/Rechs Bærearmlenke/Track control arm/Querlenker	Nederste/Lower/Unten			
3	5033235 V/H - L/R Styrekugle/Tie rod end/Kugelgelenk	14x1,5 RHT Yderste/Outer/Außen			
4	5033237 V/H - L/R Styrekugle/Tie rod end/Axialgelenk	14x1,5 RHT Inderste/Inner			
5	5094710 Ø18/54 mm. 200 mm. Manchetsæt/Boot kit/Manschetten satz				
6	5113208 Venstre/Left/Links 104 mm. Stabilisatorstang/Stabilizer rod/Diagonalstrebe				
7	5113209 Højre/Right/Rechs 104 mm. Stabilisatorstang/Stabilizer rod/Diagonalstrebe				
Bagaksel/Rear axle/Hinterachse					
8	5113214 V/H - L/R 230 mm. Stabilisatorstang/Stabilizer rod/Diagonalstrebe				





POS	 818 1972-79		
Foraksel/Front axle/Vorneachse			
1	5033202 U V/H - L/R - 12/75 Styrekugle/Tie rod end/Kugelgelenk	14x1,5 LHT Konus/Cone 12,5mm. Yderste/Outer/Außen	 1
2	5033211 U V/H - L/R 1/76 - Styrekugle/Tie rod end/Kugelgelenk	14x1,5 LHT Konus/Cone 13,5mm. Yderste/Outer/Außen	 2
POS	 929 10/72-8/77		
Foraksel/Front axle/Vorneachse			
1	5033202 U V/H - L/R - 12/75 Styrekugle/Tie rod end/Kugelgelenk	14x1,5 LHT Konus/Cone 12,5mm. Yderste/Outer/Außen	 1
2	5033211 U V/H - L/R 1/76 - Styrekugle/Tie rod end/Kugelgelenk	14x1,5 LHT Konus/Cone 13,5mm. Yderste/Outer/Außen	 2
3	5043205 U V/H - L/R - 12/75 Bærekugle/Ball joint/Radgelenk	Nederste/Lower/Unten	 3





POS	 929 19/77-7/81
	Foraksel/Front axle/Vorneachse
1	<p>5033211 U V/H - L/R 14x1,5 LHT Konus/Cone 13,5mm.  1</p> <p>Styrekugle/Tie rod end/Kugelgelenk Yderste/Outer/Außen</p>
POS	 929 II HB 8/81-6/86
	Foraksel/Front axle/Vorneachse
1	<p>5033208 V/H - L/R 14x1,6 RHT  1</p> <p>Styrekugle/Tie rod end/Kugelgelenk Yderste/Outer/Außen</p>



POS	 929 III HC 6/87-6/91
Foraksel/Front axle/Vorneachse	
1	<p>5033208 V/H - L/R Styrekugle/Tie rod end/Kugelgelenk</p> <p>14x1,6 RHT Yderste/Outer/Außen</p>  1
POS	 B 1800 10/81-8/95 & B 2000 10/81-8/95 & B 2200 Pick up 10/81-8/95
Foraksel/Front axle/Vorneachse	
1	<p>5033220 V/H - L/R Styrekugle/Tie rod end/Kugelgelenk</p> <p>14x1,5 LHT Yderste/Outer/Außen</p>  1
2	<p>5043210 V/H - L/R Bærekugle/Ball joint/Radgelenk</p> <p>Øverste/Upper/Oben</p>  2
3	<p>5043210 U V/H - L/R Bærekugle/Ball joint/Radgelenk</p> <p>Øverste/Upper/Oben</p>  3





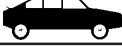



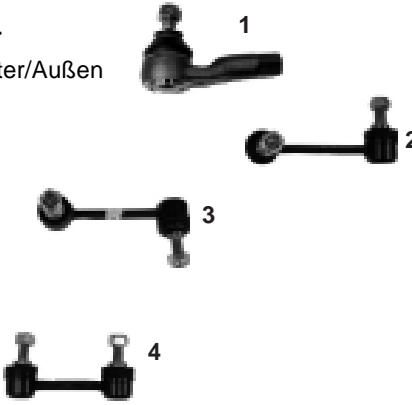

POS	 B 2000 1/85-12/96 & B 2200 UF Pick up 1/85-12/96
Foraksel/Front axle/Vorneachse	
1	<p>5033220 V/H - L/R Styrekugle/Tie rod end/Kugelgelenk 14x1,5 LHT Yderste/Outer/Außen</p>  1
2	<p>5033232 V/H - L/R - 1/87 Styrekugle/Tie rod end/Axialgelenk 14x1,5 RHT Inderste/Inner</p>  2
3	<p>5043216 V/H - L/R Bærekugle/Ball joint/Radgelenk Øverste/Upper/Oben</p>  3
4	<p>5043217 V/H - L/R - 1/87 Bærekugle/Ball joint/Radgelenk Nederste/Lower/Unten</p>  4
POS	 B 2600 4 WD UF Pick up 1/87-6/99
Foraksel/Front axle/Vorneachse	
1	<p>5043216 V/H - L/R Bærekugle/Ball joint/Radgelenk Øverste/Upper/Oben</p>  1

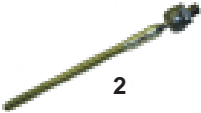
POS	Demio DW 8/98-			
Foraksel/Front axle/Vorneachse				
1	5033229 V/H - L/R Styrekugle/Tie rod end/Kugelgelenk	12x1,25 RHT Yderste/Outer/Außen		1
2	5113223 V/H - L/R Stabilisator bolt/Stabilizer bolt/Stabilisator bolzen			
POS	E 2000 5/83- & E 2200 5/83-			
Foraksel/Front axle/Vorneachse				
1	5033225 V/H - L/R Styrekugle/Tie rod end/Axialgelenk	14x1,5 RHT Inderste/Inner		1
2	5043213 V/H - L/R Bærekugle/Ball joint/Radgelenk	Øverste/Upper/Oben		2
3	5043214 V/H - L/R Bærekugle/Ball joint/Radgelenk	Nederste/Lower/Unten		3

POS	 MPV I LV 5/96-9/99
	<p>Foraksel/Front axle/Vorneachse</p> <p>1 5113215 V/H - L/R 150 mm. Stabilisator bolt/Stabilizer bolt/Stabilisator bolzen</p> <p>Bagaksel/Rear axle/Hinterachse</p> <p>2 5113216 V/H - L/R 120 mm. Stabilisator bolt/Stabilizer bolt/Stabilisator bolzen</p>
POS	 MPV II LW 9/99-
	<p>Foraksel/Front axle/Vorneachse</p> <p>1 5033235 V/H - L/R 14x1,5 RHT Styrekugle/Tie rod end/Kugelgelenk Yderste/Outer/Außen  1</p> <p>2 5113217 V/H - L/R - 8/00 266 mm. Stabilisatorstang/Stabilizer rod/Diagonalstrebe</p> <p>3 5113224 V/H - L/R 8/00 - Stabilisator/Stabilizer/Stabilisator  3</p>

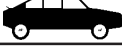
POS	 MX-3 7/91-
Foraksel/Front axle/Vorneachse	
1	<p>5033227 Venstre/Left/Links (**) 12x1,25 RHT  1 Styrekugle/Tie rod end/Axialgelenk Inderste/Inner</p>
2	<p>5033228 Højre/Right/Rechs (**) 12x1,25 RHT  2 Styrekugle/Tie rod end/Axialgelenk Inderste/Inner</p>
3	<p>5033229 V/H - L/R 12x1,25 RHT  3 Styrekugle/Tie rod end/Kugelgelenk Yderste/Outer/Außen</p>
4	<p>5113223 V/H - L/R  4 Stabilisator bolt/Stabilizer bolt/Stabilisator bolzen</p>
POS	 MX-5 I NA 5/90-4/98

POS	 MX-5 II NB 5/98-
Foraksel/Front axle/Vorneachse	
1	5113225 Venstre/Left/Links 104 mm. Stabilisator bolt/Stabilizer bolt/Stabilisator bolzen
2	5113226 Højre/Right/Rechs 104 mm. Stabilisator bolt/Stabilizer bolt/Stabilisator bolzen
	
POS	 MX-6 2/92-
Foraksel/Front axle/Vorneachse	
1	5033208 V/H - L/R 14x1,6 RHT Styrekugle/Tie rod end/Kugelgelenk Yderste/Outer/Außen
2	5113208 Venstre/Left/Links 104 mm. Stabilisatorstang/Stabilizer rod/Diagonalstrebe
3	5113209 Højre/Right/Rechs 104 mm. Stabilisatorstang/Stabilizer rod/Diagonalstrebe
Bagaksel/Rear axle/Hinterachse	
4	5113211 V/H - L/R CH. - 130204 88 mm. Stabilisatorstang/Stabilizer rod/Diagonalstrebe
	





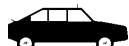



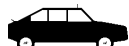



POS	 Premacy CP 7/99-
Foraksel/Front axle/Vorneachse	
1	5033235 V/H - L/R Styrekugle/Tie rod end/Kugelgelenk 14x1,5 RHT Yderste/Outer/Außen  1
2	5033245 Venstre/Left/Links Styrekugle/Tie rod end/Axialgelenk 306 mm. 14x1,5 Inderste/Inner  2
3	5033246 Højre/Right/Rechs Styrekugle/Tie rod end/Axialgelenk 310 mm. 14x1,5 Inderste/Inner  3
4	5113212 V/H - L/R Stabilisatorstang/Stabilizer rod/Diagonalstrebe 190 mm. CH. - JMZCP151177 - 8/00  4
5	5113217 V/H - L/R Stabilisatorstang/Stabilizer rod/Diagonalstrebe 266 mm. CH. JMZCP151178- 8/00 -
Bagaksel/Rear axle/Hinterachse	
6	5113213 V/H - L/R - 8/00 Stabilisatorstang/Stabilizer rod/Diagonalstrebe 193 mm.  6
7	5113227 V/H - L/R 8/00 - Stabilisatorstang/Stabilizer rod/Diagonalstrebe 160 mm.
POS	 Xedos 6 CA 1/92-
Foraksel/Front axle/Vorneachse	
1	5033235 V/H - L/R Styrekugle/Tie rod end/Kugelgelenk 14x1,5 RHT Yderste/Outer/Außen  1
2	5113208 Venstre/Left/Links Stabilisatorstang/Stabilizer rod/Diagonalstrebe 104 mm.  2
3	5113209 Højre/Right/Rechs Stabilisatorstang/Stabilizer rod/Diagonalstrebe 104 mm.  3
Bagaksel/Rear axle/Hinterachse	
4	5113211 V/H - L/R CH. - 130204 Stabilisatorstang/Stabilizer rod/Diagonalstrebe 88 mm.  4











MAZDA







POS	
POS	















MAZDA

POS	
POS	















POS	 W 168 A-Klasse 7/97-			
Foraksel/Front axle/Vorneachse				
1	5013321 Venstre/Left/Links Bærearmlenke/Track control arm/Querlenker	Nederste/Lower/Unten		
2	5013322 Højre/Right/Rechs Bærearmlenke/Track control arm/Querlenker	Nederste/Lower/Unten		
3	5033329 Venstre/Left/Links Styrekugle/Tie rod end/Kugelgelenk	12x1,5 RHT Yderste/Outer/Außen		
4	5033330 Højre/Right/Rechs Styrekugle/Tie rod end/Kugelgelenk	12x1,5 RHT Yderste/Outer/Außen		
5	5033331 V/H - L/R Styrekugle/Tie rod end/Kugelgelenk	12x1,5 RHT Inderste/Inner		
6	5043309 V/H - L/R Bærekugle/Ball joint/Radgelenk	Nederste/Lower/Unten		
7	5093301 Manchetsæt/Boot kit/Manchetten satz			
8	5103309 For/Front/Vorne Bøsning/Bushing/Buchsen	V/H - L/R		
9	5113301 Stabilisatorstang/Stabilizer rod/Diagonalstrebe			
Bagaksel/Rear axle/Hinterachse				
10	5103302 V/H - L/R Rep. Sæt til bageste svingarm/Repair kit for rear steering arm/ Reparatursatz für hinteren Schwingarm			
11	5103310 Bag/Rear/Hinten Bøsning/Bushing/Buchsen	V/H - L/R		



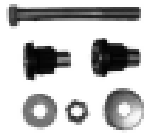

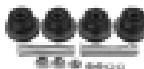











POS	 W 169 A-Klasse 9/04-			
Foraksel/Front axle/Vorneachse				
1	5013341 Venstre/Left/Links Bærearml/Track control arm/Querlenker	Nederste/Lower/Unten		
2	5013342 Højre/Right/Rechs Bærearml/Track control arm/Querlenker	Nederste/Lower/Unten		
3	5033351 Venstre/Left/Links Styrekugle/Tie rod end/Axialgelenk	14x1,5 Inderste/Inner		
4	5033352 Højre/Right/Rechs Styrekugle/Tie rod end/Axialgelenk	14x1,5 Inderste/Inner		
5	5033353 Venstre/Left/Links Styrekugle/Tie rod end/Axialgelenk	14x1,5 Yderste/Outer/Außen		
6	5033354 Højre/Right/Rechs Styrekugle/Tie rod end/Axialgelenk	14x1,5 Yderste/Outer/Außen		
7	5043319 V/H - L/R Bærekugle/Ball joint/Radgelenk			
8	5103327 For/Front/Vorne Bøsning/Bushing/Buchsen	V/H - L/R		
9	5113328 V/H - L/R Stabilisatorstang/Stabilizer rod/Diagonalstrebe	244 mm.		
Bagaksel/Rear axle/Hinterachse				
10	5103328 Bag/Rear/Hinten Bøsning/Bushing/Buchsen	V/H - L/R		
11	5113329 V/H - L/R 87 mm. Stabilisator/Stabilizer/Stabilisator			

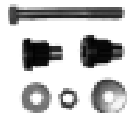













POS	W 245 B-Klasse 3/05-
Foraksel/Front axle/Vorneachse	
1	5103327 For/Front/Vorne V/H - L/R Bøsning/Bushing/Buchsen  1
2	5103328 Bag/Rear/Hinten V/H - L/R Bøsning/Bushing/Buchsen  2
3	5113328 Bag/Rear/Hinten V/H - L/R Stabilisatorstang/Stabilizer rod/Diagonalstrebe  3
4	XXXXXXX Venstre/Left/Links Styrekugle/Tie rod end/Axialgelenk
5	XXXXXXX Højre/Right/Rechs Styrekugle/Tie rod end/Axialgelenk
6	XXXXXXX V/H - L/R Stabilisator/Stabilizer/Stabilisator
Bagaksel/Rear Axle/Hinterachse	
7	5113329 V/H - L/R 87mm. Stabilisator/Stabilizer/Stabilisator
POS	200/220/230/240/D W115 1968-12/75 & 230/250/280 C/CE W114 1968-12/75
Foraksel/Front axle/Vorneachse	
1	5033301 V/H - L/R 14x1,5 LHT Styrekugle/Tie rod end/Kugelgelenk Yderste/Outer/Außen  1
2	5033302 V/H - L/R 14x1,5 Styrekugle/Tie rod end/Kugelgelenk Inderste/Inner  2
3	5043301 Bærekugle/Ball joint/Radgelenk Øverste/Upper/Oben
4	5043303 V/H - L/R Bærekugle/Ball joint/Radgelenk Nederste/Lower/Unten  4
Bagaksel/Rear axle/Hinterachse	
5	5113305 V/H - L/R Stabilisator/Stabilizer/Stabilisator  5

POS		200/220/230/240/250/280/300 W 123 1976-10/84 & 200/230/240/250/280/300 T 123 & 230/280 C 123 1976-10/84
Foraksel/Front axle/Vorneachse		
1	5003303 Midt/Center/Mitte Styrestang/Steering rod/Spurstange	V/H - L/R  1
2	5003304 V/H - L/R Styrestang/Steering rod/Spurstange	 2
3	5013301 Venstre/Left/Links Bærearml/Track control arm/Querlenker	 3
4	5013302 Højre/Right/Rechts Bærearml/Track control arm/Querlenker	 4
5	5033301 V/H - L/R Styrekugle/Tie rod end/Kugelgelenk	1/76-9/77 14x1,5 LHT Yderste/Outer/Außen  5
6	5033301 V/H - L/R Styrekugle/Tie rod end/Kugelgelenk	8/82- 14x1,5 LHT Inderste/Inner  6
7	5033303 V/H - L/R Styrekugle/Tie rod end/Kugelgelenk	1/76-9/77 14x1,5 RHT Inderste/Inner  7
8	5033304 V/H - L/R Styrekugle/Tie rod end/Kugelgelenk	10/77-7/82 16x1,5 LHT Yderste/Outer/Außen  8
9	5033305 V/H - L/R Styrekugle/Tie rod end/Kugelgelenk	10/77-7/82 16x1,5 RHT Inderste/Inner  9
10	5033319 V/H - L/R Styrekugle/Tie rod end/Kugelgelenk	8/82- 14x1,5 RHT Yderste/Outer/Außen  10
POS		
11	5043304 V/H - L/R Bærekugle/Ball joint/Radgelenk	Nederste/Lower/Unten  11
Bagaksel/Rear axle/Hinterachse		
12	5113305 V/H - L/R Stabilisatorstang/Stabilizer rod/Diagonalstrebe	 12













MERCEDES-BENZ



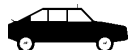







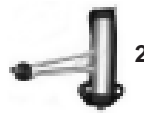

POS		W124 11/84-6/93 & W124 C (- 500E & 4 matic) 11/84-6/93 & W124 T 11/84-6/93	
Foraksel/Front axle/Vorneachse			
1	5003309 V/H - L/R Styrestang/Steering rod/Spurstange		 1
2	5003310 Midt/Center/Mitte Styrestang/Steering rod/Spurstange	-8/89 CH -1B022105-2B051199-	 2
3	5003325 Midt/Center/Mitte Styrestang/Steering rod/Spurstange	-8/89 CH 1B022105-/2B051199-	 3
4	5013304 Venstre/Left/Links Bæream/Track control arm/Querlenker	Nederste/Lower/Unten	 4
5	5013305 Højre/Right/Rechs Bæream/Track control arm/Querlenker	Nederste/Lower/Unten	 5
6	5033319 V/H - L/R Styrekugle/Tie rod end/Kugelgelenk	14x1,5 RHT Yderste/Outer/Außen	 6
7	5033321 V/H - L/R Styrekugle/Tie rod end/Kugelgelenk	14x1,5 RHT Inderste/Inner	 7
8	5043305 V/H - L/R Bærekugle/Ball joint/Radgelenk	Nederste/Lower/Unten	 8
9	5103312 Rep.sæt til mellemste styream/Repair kit for middle steering lever/ Reparatursatz für den mittleren Lenkarm		 9
POS 			
10	5103317 CH -B711095 Rep. Sæt til bagerste svingarm/Repair kit for rear steering arm/ Reparatursatz für den hinteren Svingarm	CH. -B711095 Nederste/Lower/Unten	 10
11	5103318 CH B711096- Rep. Sæt til bagerste svingarm/Repair kit for rear steering arm/ Reparatursatz für den hinteren Svingarm	CH. B711096- Nederste/Lower/Unten	 11
Bagaksel/Rear axle/Hinterachse			
12	5103303 Bag/Rear/Hinten Bæreamsbøsning/Bushing for Track control arm/ Buchsen für Querlenker	Yderste/Outer/Außen	 12
13	5113304 V/H - L/R Stabilisator arm/Stabilizer lever/Stabilisator hebel	200 mm. (Nylon) Vertikal/Vertical	 13
14	5113320 Bag/Rear/Hinten Stabilisatorstang/Stabilizer rod/Diagonalstrebe	V/H - L/R Nederste/Lower/Unten	 14
15	5113321 Bag/Rear/Hinten Stabilisatorstang/Stabilizer rod/Diagonalstrebe	V/H - L/R Øverste/Upper/Oben	 15

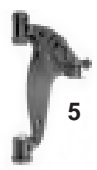



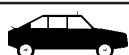

POS		W124 Lim. E-Klasse (- 500 E & 4-matic) 6/93-6/95 & W124T E-Klasse (- 4 matic) 6/93-6/96
Foraksel/Front axle/Vorneachse		
1	5003309 V/H - L/R Styrestang/Steering rod/Spurstange	 1
2	5003325 Midt/Center/Mitte Styrestang/Steering rod/Spurstange	CH 1B022105-/2B051199-  2
3	5013304 Venstre/Left/Links Bærearmlenke/Track control arm/Querlenker	Nederste/Lower/Unten  3
4	5013305 Højre/Right/Rechts Bærearmlenke/Track control arm/Querlenker	Nederste/Lower/Unten  4
5	5033319 V/H - L/R Styrekugle/Tie rod end/Kugelgelenk	Yderste/Outer/Außen  5
6	5033321 V/H - L/R Styrekugle/Tie rod end/Kugelgelenk	Inderste/Inner  6
7	5043305 V/H - L/R Bærekugle/Ball joint/Radgelenk	Nederste/Lower/Unten  7
8	5103312 Rep. sæt til mellemste styrearmlenke/Repair kit for middle steering lever/ Reparatursatz für den mittleren Lenkarm	 8
9	5103317 CH-B711095 Rep.sæt til bageste svingarm/Repair kit for rear steering arm/ Reparatursatz für hinteren Schwingarm	Nederste/Lower/Unten  9
POS		
10	5103318 CH B711096- Rep.sæt til bageste svingarm/Repair kit for rear steering arm/ Reparatursatz für hinteren Schwingarm	Nederste/Lower/Unten  10
Bagaksel/Rear axle/Hinterachse		
11	5103303 V/H - L/R Bøsning/Bushing/Buchsen	Yderste/Outer/Außen  11
12	5113304 V/H - L/R Stabilisator arm/Stabilizer lever/Stabilisator hebel	200 mm. (Nylon)  12
13	5113320 V/H - L/R Stabilisatorstang/Stabilizer rod/Diagonalstrebe	Nederste/Lower/Unten  13
14	5113321 V/H - L/R Stabilisatorstang/Stabilizer rod/Diagonalstrebe	Øverste/Upper/Oben  14

POS	 W124 Cabrio 4/92-3/98 & W124 Coupe E-Klasse 6/93-6/97
Foraksel/Front axle/Vorneachse	
1	5003309 V/H - L/R Styrestang/Steering rod/Spurstange  1
2	5003325 Midt/Center/Mitte Styrestang/Steering rod/Spurstange  2
3	5013304 Venstre/Left/Links Bærearmlenke/Track control arm/Querlenker Nederste/Lower/Unten  3
4	5013305 Højre/Right/Rechts Bærearmlenke/Track control arm/Querlenker Nederste/Lower/Unten  4
5	5033319 V/H - L/R Styrekugle/Tie rod end/Kugelgelenk 14x1,5 RHT Yderste/Outer/Außen  5
6	5033321 V/H - L/R Styrekugle/Tie rod end/Kugelgelenk 14x1,5 LHT Inderste/Inner  6
7	5043305 V/H - L/R Bærekugle/Ball joint/Radgelenk Nederste/Lower/Unten  7
8	5103312 Rep. sæt til mellemste styrearmlenke/Repair kit for middle steering lever/ Reparatursatz für den mittleren Lenkarm  8
9	5103317 CH-B711095 Rep.sæt til bageste svingarm/Repair kit for rear steering arm/ Reparatursatz für hinteren Schwingarm Nederste/Lower/Unten  9
POS	
10	5103318 CH B711096- Rep.sæt til bageste svingarm/Repair kit for rear steering arm/ Reparatursatz für hinteren Schwingarm Nederste/Lower/Unten  10
Bagaksel/Rear axle/Hinterachse	
11	5103303 V/H - L/R Bøsning/Bushing/Buchsen Yderste/Outer/Außen  11
12	5113320 V/H - L/R Stabilisatorstang/Stabilizer rod/Diagonalstrebe Nederste/Lower/Unten  12
13	5113321 V/H - L/R Stabilisatorstang/Stabilizer rod/Diagonalstrebe Øverste/Upper/Oben  13





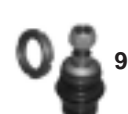
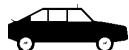















MERCEDES-BENZ

POS	 280/380/500 S/SE/SEL W126 9/79-9/85 & 380-500 SEC C126 9/79-9/85
Foraksel/Front axle/Vorneachse	
1	5013335 Venstre/Left/Links Bærearmlenke/Track control arm/Querlenker Øverste/Upper/Oben  1
2	5013336 Højre/Right/Rechs Bærearmlenke/Track control arm/Querlenker Øverste/Upper/Oben
3	5033301 V/H - L/R 14x1,5 LHT Styrekugle/Tie rod end/Kugelgelenk Yderste/Outer/Außen  3
4	5033302 V/H - L/R 14x1,5 Styrekugle/Tie rod end/Kugelgelenk Inderste/Inner  4
5	5043304 V/H - L/R Nederste bærekugle Bærekugle/Ball joint/Radgelenk Nederste/Lower/Unten  5
Bagaksel/Rear axle/Hinterachse	
6	5033301 V/H - L/R 14x1,5 LHT Styrekugle/Tie rod end/Kugelgelenk  6
7	5033302 V/H - L/R 14x1,5 Styrekugle/Tie rod end/Kugelgelenk  7
POS	 260/300/420/500/560 SE/SEL W126 9/85-6/91 & 420/500/560 SEC C126 9/85-6/91
Foraksel/Front axle/Vorneachse	
1	5013335 Venstre/Left/Links Bærearmlenke/Track control arm/Querlenker Øverste/Upper/Oben  1
2	5013336 Højre/Right/Rechs Bærearmlenke/Track control arm/Querlenker Øverste/Upper/Oben
3	5033301 V/H - L/R 14x1,5 LHT Styrekugle/Tie rod end/Kugelgelenk Yderste/Outer/Außen  3
4	5033302 V/H - L/R 14x1,5 Styrekugle/Tie rod end/Kugelgelenk Inderste/Inner  4
5	5043304 V/H - L/R Bærekugle/Ball joint/Radgelenk Nederste/Lower/Unten  5
Bagaksel/Rear axle/Hinterachse	
6	5033301 V/H - L/R 14x1,5 LHT Styrekugle/Tie rod end/Kugelgelenk Yderste/Outer/Außen  6
7	5033302 V/H - L/R 14x1,5 Styrekugle/Tie rod end/Kugelgelenk Inderste/Inner  7



POS	 W140 Lim. (300SE - 600SEL) 2/91-10/98 & W140C T (420 - 600SEC) 9/92-2/99
Foraksel/Front axle/Vorneachse	
1	5003324 V/H - L/R Styrestang/Steering rod/Spurstange  1
2	5013323 Venstre/Left/Links Bærearmlenke/Track control arm/Querlenker Øverste/Upper/Oben  2
3	5013324 Højre/Right/Rechs Bærearmlenke/Track control arm/Querlenker Øverste/Upper/Oben  3
4	5013325 Venstre/Left/Links Bærearmlenke/Track control arm/Querlenker Nederste/Lower/Unten  4
5	5013326 Højre/Right/Rechs Bærearmlenke/Track control arm/Querlenker Nederste/Lower/Unten  5
6	5033327 V/H - L/R Styrekugle/Tie rod end/Kugelgelenk 16x1,5 RHT Yderste/Outer/Außen  6
7	5033328 V/H - L/R Styrekugle/Tie rod end/Kugelgelenk 16x1,5 LHT Inderste/Inner  7
8	5043307 V/H - L/R Bærekugle/Ball joint/Radgelenk Nederste/Lower/Unten  8
9	5103304 Rep. sæt til bageste svingarm/Repair kit for rear steering arm/ Øverste/Upper/Oben Reparatursatz für hinteren Schwingarm  9
POS	
10	5103305 Rep. sæt til bageste svingarm/Repair kit for rear steering arm/ Nederste/Lower/Unten Reparatursatz für hinteren Schwingarm
11	5113311 Venstre/Left/Links 153 mm. Stabilisator bolt/Stabilizer bolt/Stabilisator bolzen  11
12	5113312 Højre/Right/Rechs 153 mm. Stabilisator bolt/Stabilizer bolt/Stabilisator bolzen  12
Bagaksel/Rear axle/Hinterachse	
13	5113310 V/H - L/R 230 mm. Stabilisatorstang/Stabilizer rod/Diagonalstrebe  13

POS	 W163 ML 2/98-
Foraksel/Front axle/Vorneachse	
1	5013347 Venstre/Left/Links Bærearmlenke/Track control arm/Querlenker Øverste/Upper/Oben
2	5013348 Højre/Right/Rechs Bærearmlenke/Track control arm/Querlenker Øverste/Upper/Oben
3	5013349 Venstre/Left/Links Bærearmlenke/Track control arm/Querlenker Øverste/Upper/Oben
4	5013350 Højre/Right/Rechs Bærearmlenke/Track control arm/Querlenker Øverste/Upper/Oben
5	5033332 V/H - L/R 16x1,5 RHT Styrekugle/Tie rod end/Axialgelenk Inderste/Inner  5
6	5033341 Venstre/Left/Links Styrekugle/Tie rod end/Kugelgelenk Yderste/Outer/Außen  6
7	5033342 Højre/Right/Rechs 16x1,5 Konus/Cone 18,0 mm. Styrekugle/Tie rod end/Kugelgelenk Yderste/Outer/Außen  7
8	5043312 V/H - L/R Bærekugle/Ball joint/Radgelenk Nederste/Lower/Unten  8
Bagaksel/Rear axle/Hinterachse	
9	5043313 V/H - L/R Bærekugle/Ball joint/Radgelenk Nederste/Lower/Unten  9
POS	 W 164 M-Klasse 7/05-
Foraksel/Front axle/Vorneachse	
1	5113330 V/H - L/R 198 mm. Stabilisatorstang/Stabilizer rod/Diagonalstrebe  1
Bagaksel/Rear axle/Hinterachse	
2	5113331 V/H - L/R 116 mm. Stabilisatorstang/Stabilizer rod/Diagonalstrebe







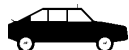









POS	W201 190 D/E 10/82-8/93			
Foraksel/Front axle/Vorneachse				
1	5003307 Midt/Center/Mitte Styrestang/Steering rod/Spurstange		1	
2	5003312 V/H - L/R Styrestang/Steering rod/Spurstange		2	
3	5013304 Venstre/Left/Links (Sport) Bærearmlenke/Track control arm/Querlenker		3	
4	5013305 Højre/Right/Rechs (Sport) Bærearmlenke/Track control arm/Querlenker			4
5	5013306 Venstre/Left/Links (1.8/2.0/2.0D/2.5D Ex. Sport) Bærearmlenke/Track control arm/Querlenker			
6	5013307 (1.8/2.0/2.0D/2.5D Ex. Sport) Bærearmlenke/Track control arm/Querlenker		Højre/Right/Rechs	
7	5013308 Venstre/Left/Links Bærearmlenke/Track control arm/Querlenker	(2.3/2.5 TD/2.6 Ex. Sport)		
8	5013309 Højre/Right/Rechs Bærearmlenke/Track control arm/Querlenker	(2.3/2.5 TD/2.6 Ex. Sport)		
9	5033316 Venstre/Left/Links Styrekugle/Tie rod end/Kugelgelenk	Til / For / Für 5003311	12x1,5 RHT	
10	5033322 Højre/Right/Rechs Styrekugle/Tie rod end/Kugelgelenk	Til / For / Für 5003312	12x1,5 RHT	
Yderste/Outer/Außen				
POS				
11	5033317 V/H - L/R Styrekugle/Tie rod end/Axialgelenk	Til / For / Für 5003311/12	12x1,5 LHT	
12	5043305 V/H - L/R Bærekugle/Ball joint/Radgelenk	Nederste/Lower/Unten		
14	5103313 V/H - L/R Rep. Sæt t/styrearmlenke/Repair kit for idler arm/ Reparatursatz für Lenkzwischenhebel		14	
15	5103317 Sport Rep. Sæt t/bagerste svingarm/Repair kit for rear steering arm/ Reparatursatz für hinteren Schwingarm	Ch. A675431/-F920107-		
16	5103318 Sport Rep. Sæt t/bagerste svingarm/Repair kit for rear steering arm/ Reparatursatz für hinteren Schwingarm	Ch. -A675432/-F920108		
17	5103319 (2.3/2.5 TD/2.6 Ex. Sport) Rep. Sæt t/bagerste svingarm/Repair kit for rear steering arm/ Reparatursatz für hinteren Schwingarm	Ch. A675432/-F920108-		
Bagaksel/Rear axle/Hinterachse				
13	5103303 V/H - L/R Bøsning/Bushing/Buchsen	Yderste/Outer/Außen		
14	5113304 V/H - L/R Stabilisator arm/Stabilizer lever/Stabilisator hebel	200 mm. (Nylon)	Vertikal/Vertical	
15	5113320 V/H - L/R Stabilisatorstang/Stabilizer rod/Diagonalstrebe	Nederste/Lower/Unten		

POS		W202 (C180-C280) 3/93-5/00 & W202 T (C180-C250 TD) 6/96-3/01	
Foraksel/Front aksel/Vorneachse			
1	5003323 Midt/Center/Mitte Styrestang/Steering rod/Spurstange	(- C240/C280/C43 AMG)	 1
2	5003328 Midt/Center/Mitte Styrestang/Steering rod/Spurstange	(C240/C280/C43 AMG)	 2
3	5013312 Venstre/Left/Links Bærearmlenke/Track control arm/Querlenker	Nederste/Lower/Unten	 3
4	5013313 Højre/Right/Rechts Bærearmlenke/Track control arm/Querlenker	Nederste/Lower/Unten	 4
5	5013314 Venstre/Left/Links Bærearmlenke/Track control arm/Querlenker	(ABS) Øverste/Upper/Oben	 5
6	5013315 Højre/Right/Rechts Bærearmlenke/Track control arm/Querlenker	(ABS) Øverste/Upper/Oben	 6
7	5033326 V/H - L/R Styrekugle/Tie rod end/Kugelgelenk	12x1,5 RHT Yderste/Outer/Außen	 7
8	5043308 V/H - L/R Bærekugle/Ball joint/Radgelenk	Nederste/Lower/Unten	 8
9	5103306 V/H - L/R Bøsning/Bushing/Buchsen	Til / For / Für 5013314/15	 9
10	5103315 For/Front/Vorne Bøsning/Bushing/Buchsen	V/H - L/R Nederste/Lower/Unten	 10
POS 			
11	5103316 Bag/Rear/Hinten Bøsning/Bushing/Buchsen	V/H - L/R Nederste/Lower/Unten	 11
12	5103320 V/H - L/R Rep. sæt t/styrearmlenke/Repair kit for idler arm/ Reparatursatz für Lenkzwischenhebel		 12
Bagaksel/Rear axle/Hinterachse			
13	5103307 V/H - L/R Bøsning/Bushing/Buchsen	Til / For / Für 5003321	 13
14	5103308 V/H - L/R Rep. sæt t/bageste svingarm/Repair kit for rear steering arm/ Reparatursatz für hinteren Schwingarm		 14
15	5113302 For/Front/Vorne Stabilisator arm/Stabilizer lever/Stabilisator hebel	V/H - L/R Øverste/Upper/Oben	 15
16	5113303 For/Front/Vorne Stabilisator arm/Stabilizer lever/Stabilisator hebel	V/H - L/R Nederste/Lower/Unten	 16
17	5113304 V/H - L/R Stabilisator arm/Stabilizer lever/Stabilisator hebel	200 mm. (Nylon) Vertikal/Vertical	 17
18	5113320 Bag/Rear/Hinten Stabilisatorstang/Stabilizer rod/Diagonalstrebe	V/H - L/R Nederste/Lower/Unten	 18
19	5113321 Bag/Rear/Hinten Stabilisatorstang/Stabilizer rod/Diagonalstrebe	V/H - L/R Øverste/Upper/Oben	 19

POS	W203 C 5/00-				
Foraksel/Front axle/Vorneachse					
1	5013327 Venstre/Left/Links Bærearmlenke/Track control arm/Querlenker	Øverste/Upper/Oben		1	
2	5013328 Højre/Right/Rechts Bærearmlenke/Track control arm/Querlenker	Øverste/Upper/Oben		2	
3	5013329 Venstre/Left/Links Bærearmlenke/Track control arm/Querlenker	Nederste/Lower/Unten		3	
4	5013330 Højre/Right/Rechts Bærearmlenke/Track control arm/Querlenker	Nederste/Lower/Unten		4	
5	5033338 V/H - L/R Styreknude/Tie rod end/Axialgelenk	Inderste/Inner		5	
6	5033339 Venstre/Left/Links Styreknude/Tie rod end/Kugelgelenk	Yderste/Outer/Außen		6	
7	5033340 Højre/Right/Rechts Styreknude/Tie rod end/Kugelgelenk	Yderste/Outer/Außen		7	
8	5103311 V/H - L/R Bøsning/Bushing/Buchsen	Øverste/Upper/Oben			
9	5103314 V/H - L/R Bøsning/Bushing/Buchsen	Nederste/Lower/Unten		9	
10	5113337 V/H - L/R Ex. C230, 4-Matic & Sport Stabilisator/Stabilizer/Stabilisator				
POS					
11	5113338 V/H - L/R 4-Matic Stabilisator/Stabilizer/Stabilisator				
12	5113339 V/H - L/R C-230 Stabilisator/Stabilizer/Stabilisator			11	
Bagaksel/Rear axle/Hinterachse					
13	5103303 V/H - L/R Bøsning/Bushing/Buchsen	Yderste/Outer/Außen		13	
14	5113302 For/Front/Vorne Stabilisatorarm/Stabilizer lever/Stabilisator hebel	V/H - L/R Øverste/Upper/Oben		14	
15	5113303 For/Front/Vorne Stabilisatorarm/Stabilizer lever/Stabilisator hebel	V/H - L/R Nederste/Lower/Unten		15	
16	5113320 V/H - L/R Stabilisatorstang/Stabilizer rod/Diagonalstrebe	Nederste/Lower/Unten		16	
17	5113335 Venstre/Left/Links Stabilisator/Stabilizer/Stabilisator	188 mm.		17	
18	5113336 Højre/Right/Rechts Stabilisator/Stabilizer/Stabilisator	188 mm.		18	

POS		W204 S204 C Klasse 1/07-
Foraksel/Front axle/Vorneachse		
1	Venstre/Left/Links	Stabilisator arm/stabilizer lever/Stabilisator hebel
2	Højre/Right/Rechs	Stabilisator arm/Stabilizer lever/Stabilisator hebel
3	Venstre/Left/Links (Sport suspension)	Stabilisator arm/Stabilizer lever/Stabilisator hebel
4	Højre/Right/Rechs (Sport suspension)	Stabilisator arm/Stabilizer lever/Stabilisator hebel
5	Venstre/Left/Links	Styrekugle/Tie rod end/Axialgelenk Yderste/Outer/Außen
6	Højre/Right/Rechs	Styrekugle/Tie rod end/Axialgelenk Yderste/Outer/Außen
7	V/H - L/R	Styrekugle/Tie rod end/Axialgelenk Innerste/Inner
8	5013327 Venstre/Left/Links	Bærearml/Track control arm/Querlenker Øverste/Upper/Oben
9	5013328 Højre/Right/Rechs	Bærearml/Track control arm/Querlenker Øverste/Upper/Oben
		 8
		 9
POS		

MERCEDES-BENZ





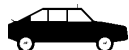

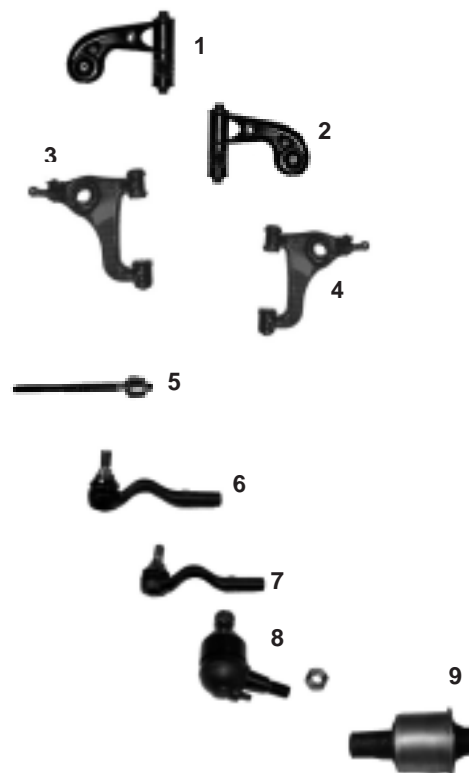







POS	 W208 C CLK - CLK Cabrio 6/97-			
Foraksel/Front axle/Vorneachse				
1	5013312 Venstre/Left/Links Bærearmlenke/Track control arm/Querlenker	(ABS) Nederste/Lower/Unten		
2	5013313 Højre/Right/Rechs Bærearmlenke/Track control arm/Querlenker	(ABS) Nederste/Lower/Unten		
3	5013314 Venstre/Left/Links Bærearmlenke/Track control arm/Querlenker	(ABS) Øverste/Upper/Oben		
4	5013315 Højre/Right/Rechs Bærearmlenke/Track control arm/Querlenker	(ABS) Øverste/Upper/Oben		
5	5033326 V/H - L/R Styreknude/Tie rod end/Kugelgelenk	12x1,5 RHT Yderste/Outer/Außen		
6	5043308 V/H - L/R Bærekugle/Ball joint/Radgelenk	Nederste/Lower/Unten		
7	5103306 V/H - L/R Bøsning/Bushing/Buchsen	Øverste/Upper/Oben		
8	5103315 For/Front/Vorne Bøsning/Bushing/Buchsen	V/H - L/R Nederste/Lower/Unten		
9	5103316 Bag/Rear/Hinten Bøsning/Bushing/Buchsen	V/H - L/R Nederste/Lower/Unten		
Bagaksel/Rear axle/Hinterachse				
10	5103303 V/H - L/R Bøsning/Bushing/Buchsen	Yderste/Outer/Außen		
11	5113302 For/Front/Vorne Stabilisatorarm/Stabilizer lever/Stabilisator hebel	V/H - L/R Øverste/Upper/Oben		
12	5113303 For/Front/Vorne Stabilisatorarm/Stabilizer lever/Stabilisator hebel	V/H - L/R Nederste/Lower/Unten		
13	5113304 V/H - L/R Stabilisatorarm/Stabilizer lever/Stabilisator hebel	200 mm. (Nylon) Vertikal/Vertical		
14	5113320 Bag/Rear/Hinten Stabilisatorstang/Stabilizer rod/Diagonalstrebe	V/H - L/R Nederste/Lower/Unten		
15	5113321 Bag/Rear/Hinten Stabilisatorstang/Stabilizer rod/Diagonalstrebe	V/H - L/R Øverste/Upper/Oben		

MERCEDES-BENZ











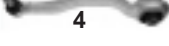

POS	 W209 C 9/02-
POS	 W210 Lim. (E200-E50AMG) 6/95-3/02 & W210 T (E200-E420) 6/96-3/03
Foraksel/Front axle/Vorneachse	
1	5013314 Venstre/Left/Links Bærearmlenke/Track control arm/Querlenker Øverste/Upper/Oben
2	5013315 Højre/Right/Rechts Bærearmlenke/Track control arm/Querlenker Øverste/Upper/Oben
3	5013337 Venstre/Left/Links Bærearmlenke/Track control arm/Querlenker Nederste/Lower/Unten
4	5013338 Højre/Right/Rechts Bærearmlenke/Track control arm/Querlenker Nederste/Lower/Unten
5	5033323 V/H - L/R Styreknude/Tie rod end/Axialgelenk 14x1,5 RHT Inderste/Inner
6	5033324 Venstre/Left/Links Styreknude/Tie rod end/Kugelgelenk 14x1,5 RHT Yderste/Outer/Außen
7	5033325 Højre/Right/Rechts Styreknude/Tie rod end/Kugelgelenk 14x1,5 RHT Yderste/Outer/Außen
8	5043308 V/H - L/R Bærekugle/Ball joint/Radgelenk Nederste/Lower/Unten
9	5103306 V/H - L/R Bøsning/Bushing/Buchsen Øverste/Upper/Oben





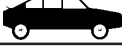





MERCEDES-BENZ

POS		W210 Lim. (E200-E50AMG) 6/95-3/02 & W210 T (E200-E420) 6/96-3/03	
Foraksel/Front axle/Vorneachse			
10	5103323 For/Front/Vorne Bøsning/Bushing/Buchsen	V/H - L/R Nederste/Lower/Unten	 10  11
11	5103324 Bag/Rear/Hinten Bøsning/Bushing/Buchsen	V/H - L/R Nederste/Lower/Unten	 12
12	5113318 Venstre/Left/Links Stabilisatorstang/Stabilizer rod/Diagonalstrebe		 13
13	5113319 Højre/Right/Rechs Stabilisatorstang/Stabilizer rod/Diagonalstrebe		 14  15
Bagaksel/Rear axle/Hinterachse			
14	5103303 V/H - L/R Bøsning/Bushing/Buchsen	V/H - L/R Yderste/Outer/Außen	 16  17
15	5103321 For/Front/Vorne V/H - L/R Rep. sæt t/bagbro/Repair kit, axle body/ Reparatursatz, Achskörper		
16	5103322 Bag/Rear/Hinten V/H - L/R Rep. sæt t/bagbro/Repair kit, axle body/ Reparatursatz, Achskörper		
17	5113302 For/Front/Vorne V/H - L/R Stabilisator arm/Stabilizer lever/Stabilisator hebel	V/H - L/R Øverste/Upper/Oben	
POS			
18	5113303 For/Front/Vorne Stabilisator arm/Stabilizer lever/Stabilisator hebel	V/H - L/R Nederste/Lower/Unten	 18
19	5113304 V/H - L/R Ex. St. car Stabilisator arm/Stabilizer lever/Stabilisator hebel	200 mm. (Nylon) Vertikal/Vertical	 19
20	5113320 Bag/Rear/Hinten Stabilisatorstang/Stabilizer rod/Diagonalstrebe	V/H - L/R Nederste/Lower/Unten	 20
21	5113321 Bag/Rear/Hinten Stabilisatorstang/Stabilizer rod/Diagonalstrebe	V/H - L/R Øverste/Upper/Oben	 21
22	5113345 V/H - L/R St. car Stabilisatorstang/Stabilizer rod/Diagonalstrebe	200 mm. Vertikal/Vertical	 22

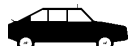

MERCEDES-BENZ

POS		S211 E (E200-E55AMG) 3/03- & W211 E (E200-E55AMG) 7/02-
Foraksel/Front axle/Vorneachse		
1	5013343 Venstre/Left/Links Bærearmlenke/Track control arm/Querlenker	Øverste/Upper/Oben 
2	5013344 Højre/Right/Rechs Bærearmlenke/Track control arm/Querlenker	Øverste/Upper/Oben 
3	5013351 Venstre/Left/Links Bærearmlenke/Track control arm/Querlenker	Nederste/Lower/Unten 
4	5013352 Højre/Right/Rechs Bærearmlenke/Track control arm/Querlenker	Nederste/Lower/Unten 
5	5013353 Venstre/Left/Links Bærearmlenke/Track control arm/Querlenker	Nederste/Lower/Unten 
6	5013354 Højre/Right/Rechs Bærearmlenke/Track control arm/Querlenker	Nederste/Lower/Unten 
7	5033338 V/H - L/R Styreaksel/Tie rod end/Axialgelenk	Inderste/Inner 
8	5033357 Venstre/Left/Links Styreaksel/Tie rod end/Kugelgelenk	Yderste/Outer/Außen
9	5033358 Højre/Right/Rechs Styreaksel/Tie rod end/Kugelgelenk	Yderste/Outer/Außen
10	5043316 V/H - L/R Bærekugle/Ball joint/Radgelenk	Nederste/Lower/Unten 
POS		
11	5043320 V/H - L/R Bærekugle/Ball joint/Radgelenk	Øverste/Upper/Oben 
12	5113333 Venstre/Left/Links 132 mm. Stabilisatorstang/Stabilizer rod/Diagonalstrebe	
13	5113334 Højre/Right/Rechs 132 mm. Stabilisatorstang/Stabilizer rod/Diagonalstrebe	
Bagaksel/Rear axle/Hinterachse		
14	5113332 V/H - L/R 261 mm. Stabilisatorstang/Stabilizer rod/Diagonalstrebe	





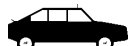

MERCEDES-BENZ

POS	 C215 CL (CL500-CL65AMG) 3/99-
Foraksel/Front axle/Vorneachse	
1	5013355 Venstre/Left/Links Bærearmlenke/Track control arm/Querlenker Øverste/Upper/Oben
2	5013356 Højre/Right/Rechts Bærearmlenke/Track control arm/Querlenker Øverste/Upper/Oben
3	5043316 V/H - L/R Bærekugle/Ball joint/Radgelenk Nederste/Lower/Unten
	 3
POS	 W220 S (S280-S65AMG) 10/98-
Foraksel/Front axle/Vorneachse	
1	5013355 Venstre/Left/Links Bærearmlenke/Track control arm/Querlenker Øverste/Upper/Oben
2	5013356 Højre/Right/Rechts Bærearmlenke/Track control arm/Querlenker Øverste/Upper/Oben
3	5033355 V/H - L/R Styrekugle/Tie rod end/Kugelgelenk 14x1,5 Yderste/Outer/Außen
4	5043316 V/H - L/R Bærekugle/Ball joint/Radgelenk Nederste/Lower/Unten
	 3
	 4
	 5
	 6
	 7
	 8
Bagaksel/Rear axle/Hinterachse	
5	5013331 V/H - L/R Bærearmlenke/Track control arm/Querlenker Øverste/Upper/Oben
6	5013332 V/H - L/R Bærearmlenke/Track control arm/Querlenker Øverste/Upper/Oben
7	5013333 V/H - L/R Bærearmlenke/Track control arm/Querlenker Nederste/Lower/Unten
8	5113310 V/H - L/R Stabilisatorstang/Stabilizer rod/Diagonalstrebe 230 mm.







MERCEDES-BENZ

POS		W221 S (S320-S65 AMG) 12/05-
Foraksel/Front axle/Vorneachse		
1	5113341 Venstre/Left/Links Stabilisatorstang/Stabilizer rod/Diagonalstrebe	
2	5113342 Højre/Right/Rechs Stabilisatorstang/Stabilizer rod/Diagonalstrebe	
Bagaksel/Rear axle/Hinterachse		
3	5113343 Venstre/Left/Links Stabilisatorstang/Stabilizer rod/Diagonalstrebe	
4	5113344 Højre/Right/Rechs Stabilisatorstang/Stabilizer rod/Diagonalstrebe	
POS		R230 SL (SL350-SL65AMG) 10/01-
Foraksel/Front axle/Vorneachse		
1	5043316 V/H - L/R Bærekugle/Ball joint/Radgelenk	Nederste/Lower/Unten  1

MERCEDES-BENZ





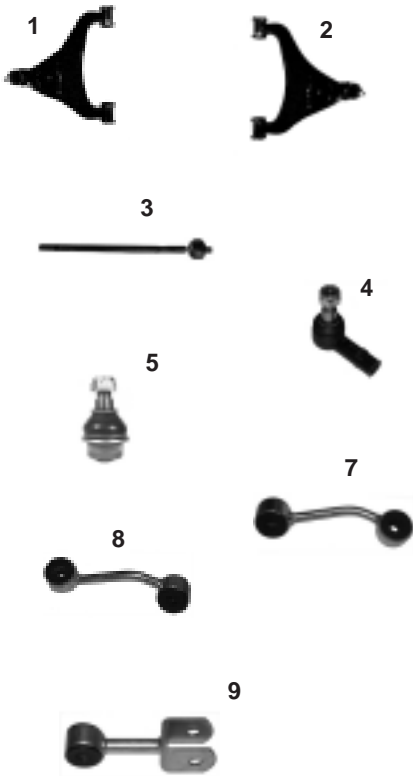
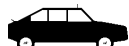

POS	 L 206 & L 306			
Foraksel/Front axle/Vorneachse				
1	5003315 Midt/Center/Mitte Styrestang/Steering rod/Spurstange	Diesel		
2	5043306 Bærekugle/Ball joint/Radgelenk		Nederste/Lower/Unten	
3	5043306 Bærekugle/Ball joint/Radgelenk		Øverste/Upper/Oben	
POS	 207 D & 208 & 308			
Foraksel/Front axle/Vorneachse				
1	5003316 V/H - L/R Styrestang/Steering rod/Spurstange	Ch. -152683/-152919		 1
2	5033334 Venstre/Left/Links Styrekugle/Tie rod end/Kugelgelenk	20x1,5 LHT Yderste/Outer/Außen		 2
3	5033335 Højre/Right/Rechs Styrekugle/Tie rod end/Kugelgelenk	20x1,5 RHT Yderste/Outer/Außen		 3
4	5073304 V/H - L/R Styreboltsæt/Steering pin set/Lenkzapfen satz			 4

MERCEDES-BENZ

POS	 209 D & 210/210 D & 309 D & 310 D			
	Foraksel/Front axle/Vorneachse			
1	5003316 V/H - L/R Styrestang/Steering rod/Spurstange	Ch. -152683/-152919		
2	5033334 Venstre/Left/Links Styrekugle/Tie rod end/Kugelgelenk	20x1,5 LHT Yderste/Outer/Außen		
3	5033335 Højre/Right/Rechs Styrekugle/Tie rod end/Kugelgelenk	20x1,5 RHT Yderste/Outer/Außen		
	Foraksel/Front axle/Vorneachse			
POS	 MB 100 (631) 2/88-2/96			
	Foraksel/Front axle/Vorneachse			
1	5043310 V/H - L/R Bærekugle/Ball joint/Radgelenk	Øverste/Upper/Oben		
2	5043310 V/H - L/R Bærekugle/Ball joint/Radgelenk	Nederste/Lower/Unten		

MERCEDES-BENZ

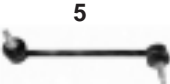









POS	 Sprinter 2/95-
Foraksel/Front axle/Vorneachse	
1	5013345 Venstre/Left/Links Bærearmlenke/Track control arm/Querlenker Nederste/Lower/Unten
2	5013346 Højre/Right/Rechs Bærearmlenke/Track control arm/Querlenker Nederste/Lower/Unten
3	5033336 V/H - L/R Styrekugle/Tie rod end/Axialgelenk Inderste/Inner
4	5033337 V/H - L/R Styrekugle/Tie rod end/Kugelgelenk 16x1,5 Yderste/Outer/Außen
5	5043311 V/H - L/R Bærekugle/Ball joint/Radgelenk Nederste/Lower/Unten
6	5093302 Manchetsæt/Boot kit/Manschetten satz
7	5113307 Venstre/Left/Links Stabilisator/Stabilizer/Stabilisator Ø14 mm. 115 mm.
8	5113308 Højre/Right/Rechs Stabilisator/Stabilizer/Stabilisator Ø14 mm. 115 mm.
Bagaksel/Rear axle/Hinterachse	
9	5113309 V/H - L/R (-4-T) Stabilisator/Stabilizer/Stabilisator Ø12 mm. 95 mm.
	
POS	 Sprinter (906) 6/06-
Foraksel/Front axle/Vorneachse	
1	xxxxxxx V/H - L/R Styrekugle/Tie rod end/Kugelgelenk



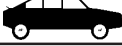



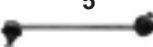





POS	 Vaneo (414) 2/02-				
		Foraksel/Front axle/Vorneachse			
1	5033347 Venstre/Left/Links Styrekugle/Tie rod end/Kugelgelenk	Yderste/Outer/Außen			
2	5033348 Højre/Right/Rechs Styrekugle/Tie rod end/Kugelgelenk	Yderste/Outer/Außen			
3	5033349 V/H - L/R Styrekugle/Tie rod end/Axialgelenk	Inderste/Inner			
4	5043318 V/H - L/R Bærekugle/Ball joint/Radgelenk	Nederste/Lower/Unten			
5	5113327 V/H - L/R Stabilisator/Stabilizer/Stabilisator				
POS					

MERCEDES-BENZ

POS	Viano (W639) 9/03-				
Foraksel/Front axle/Vorneachse					
1	5033333 V/H - L/R Styrekugle/Tie rod end/Axialgelenk	Inderste/Inner			
2	5033345 Venstre/Left/Links Styrekugle/Tie rod end/Kugelgelenk	Yderste/Outer/Außen			
3	5033346 Højre/Right/Rechs Styrekugle/Tie rod end/Kugelgelenk	Yderste/Outer/Außen			
4	5043317 V/H - L/R Bærekugle/Ball joint/Radgelenk	Nederste/Lower/Unten			
5	5113325 Venstre/Left/Links Stabilisatorstang/Stabilizer rod/Diagonalstrebe				
6	5113326 Højre/Right/Rechs Stabilisatorstang/Stabilizer rod/Diagonalstrebe				
POS Vito (638) 2/96-					
Foraksel/Front axle/Vorneachse					
1	5013339 Venstre/Left/Links Bærearmlenke/Track control arm/Querlenker				
2	5013340 Højre/Right/Rechs Bærearmlenke/Track control arm/Querlenker				
3	5033343 V/H - L/R Styrekugle/Tie rod end/Kugelgelenk	Yderste/Outer/Außen			
4	5033344 V/H - L/R Styrekugle/Tie rod end/Axialgelenk	Inderste/Inner			
5	5043314 V/H - L/R Bærekugle/Ball joint/Radgelenk	Nederste/Lower/Unten			
6	5093303 Manchetsæt/Boot kit/Manschetten satz				
7	5103325 For/Front/Vorne Bøsning/Bushing/Buchsen	V/H - L/R			
8	5103326 Bag/Rear/Hinten Bøsning/Bushing/Buchsen	V/H - L/R			
9	5113313 Venstre/Left/Links Stabilisatorstang/Stabilizer rod/Diagonalstrebe	(-CDI) 250 mm.			

MERCEDES-BENZ

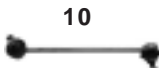
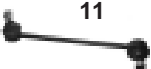
POS	 Vito (638) 2/96-
Foraksel/Front axle/Vorneachse	
10	5113314 Højre/Right/Rechs (-CDI) 250 mm. Stabilisatorstang/Stabilizer rod/Diagonalstrebe 
11	5113322 Højre/Right/Rechs (CDI) 232 mm. Stabilisatorstang/Stabilizer rod/Diagonalstrebe 
12	5113323 Venstre/Left/Links (CDI) 232 mm. Stabilisatorstang/Stabilizer rod/Diagonalstrebe 
Bagaksel/Rear axle/Hinterachse	
13	5113315 V/H - L/R 130 mm. Stabilisator/Stabilizer/Stabilisator 
POS	 Vito (W639) 9/03-
Foraksel/Front axle/Vorneachse	
1	5033333 V/H - L/R Styrekugle/Tie rod end/Axialgelenk Inderste/Inner 
2	5033345 Venstre/Left/Links Styrekugle/Tie rod end/Kugelgelenk Yderste/Outer/Außen 
3	5033346 Højre/Right/Rechs Styrekugle/Tie rod end/Kugelgelenk Yderste/Outer/Außen 
4	5043317 V/H - L/R Bærekugle/Ball joint/Radgelenk Nederste/Lower/Unten 
5	5113325 Venstre/Left/Links Stabilisatorstang/Stabilizer rod/Diagonalstrebe 
6	5113326 Højre/Right/Rechs Stabilisatorstang/Stabilizer rod/Diagonalstrebe 



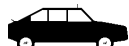

POS	 V-klasse (638/2) 2/97-			
Foraksel/Front axle/Vorneachse				
1	5013339 Venstre/Left/Links Bærearmlenke/Track control arm/Querlenker			
2	5013340 Højre/Right/Rechs Bærearmlenke/Track control arm/Querlenker			
3	5033343 V/H - L/R Styrekugle/Tie rod end/Kugelgelenk	Yderste/Outer/Außen		
4	5033344 V/H - L/R Styrekugle/Tie rod end/Axialgelenk	Inderste/Inner		
5	5043314 V/H - L/R Bærekugle/Ball joint/Radgelenk	Nederste/Lower/Unten		
6	5093303 Manchetsæt/Boot kit/Manschetten satz			
7	5103325 For/Front/Vorne Bøsning/Bushing/Buchsen	V/H - L/R		
8	5103326 Bag/Rear/Hinten Bøsning/Bushing/Buchsen	V/H - L/R		
9	5113313 Venstre/Left/Links (-CDI) 250 mm. Stabilisatorstang/Stabilizer rod/Diagonalstrebe			
POS 				
10	5113314 Højre/Right/Rechs (-CDI) 250 mm. Stabilisatorstang/Stabilizer rod/Diagonalstrebe			
11	5113322 Højre/Right/Rechs (CDI) 232 mm. Stabilisatorstang/Stabilizer rod/Diagonalstrebe			
12	5113323 Venstre/Left/Links (CDI) 232 mm. Stabilisatorstang/Stabilizer rod/Diagonalstrebe			
Bagaksel/Rear axle/Hinterachse				
13	5113315 V/H - L/R Stabilisator/Stabilizer/Stabilisator			

MERCEDES-BENZ

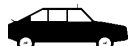





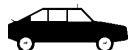

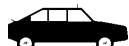

POS	
POS	















MERCEDES-BENZ

















POS	
POS	



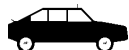



POS		Smart	7/98-		
Foraksel/Front axle/Vorneachse					
1		5043315	Bærekugle/Ball joint/Radgelenk	Øverste/Upper/Oben	 1/2
2		5043315	Bærekugle/Ball joint/Radgelenk	Nederste/Lower/Unten	
3		5113316 V/H - L/R	Stabilisator bolt/Stabilizer bolt/Stabilisator bolzen		 2
Bagaksel/Rear axle/Hinterachse					
4		5113317 V/H - L/R	Stabilisator bolt/Stabilizer bolt/Stabilisator bolzen		 4
POS					





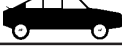

POS	
POS	







POS	 Carisma DA 7/95-
Foraksel/Front axle/Vorneachse	
1	5033014 V/H - L/R Styrekugle/Tie rod end/Kugelgelenk 12x1,25 RHT Yderste/Outer/Außen  1
2	5043009 V/H - L/R Bærekugle/Ball joint/Radgelenk Ø15 mm. Nederste/Lower/Unten  2
3	5093001 Manchetsæt/Boot kit/Manschetten satz  3
4	5114804 V/H - L/R Stabilisatorstang/Stabilizer rod/Diagonalstrebe 200 mm.  4
Bagaksel/Rear axle/Hinterachse	
5	5114805 V/H - L/R 105 mm. Stabilisator/Stabilizer/Stabilisator  5
POS	 Colt I A151A - A153A 12/78-1/84 & Colt I A155A - A157A 12/78-1/84
Foraksel/Front axle/Vorneachse	
1	5033001 V/H - L/R Styrekugle/Tie rod end/Kugelgelenk 14x1,5 RHT Yderste/Outer/Außen  1
2	5043001 U Venstre/Left/Links Bærekugle/Ball joint/Radgelenk Nederste/Lower/Unten  2
3	5043002 U Højre/Right/Rechs Bærekugle/Ball joint/Radgelenk Nederste/Lower/Unten  3
4	5113002 V/H - L/R Stabilisatorbolt/Stabilizer bolt/Stabilisator bolzen 140 mm.  4









POS	 Colt II C11A - C37W 2/84-4/88			
		Foraksel/Front axle/Vorneachse		
1	5013001 U Venstre/Left/Links Bærearml/Track control arm/Querlenker	Nederste/Lower/Unten		
2	5013002 U Højre/Right/Rechs Bærearml/Track control arm/Querlenker	Nederste/Lower/Unten		
3	5033010 U V/H - L/R Styrekugle/Tie rod end/Kugelgelenk	14x1,5 RHT Konus/Cone 13,4 mm. Yderste/Outer/Außen		
4	5033014 V/H - L/R Styrekugle/Tie rod end/Kugelgelenk	1/86- 12x1,25 RHT Yderste/Outer/Außen		
5	5043009 V/H - L/R Bærekugle/Ball joint/Radgelenk	Ø15 mm. Nederste/Lower/Unten		
6	5113002 V/H - L/R Stabilisatorbolt/Stabilizer bolt/Stabilisator bolzen	-1/86 140 mm.		
POS	 Colt III C50 Serie 4/88-5/92			
		Foraksel/Front axle/Vorneachse		
1	5013011 Venstre/Left/Links Bærearml/Track control arm/Querlenker	Nederste/Lower/Unten		
2	5013012 Højre/Right/Rechs Bærearml/Track control arm/Querlenker	Nederste/Lower/Unten		
3	5033014 V/H - L/R Styrekugle/Tie rod end/Kugelgelenk	12x1,25 RHT Yderste/Outer/Außen		
4	5043009 V/H - L/R Bærekugle/Ball joint/Radgelenk	Ex. C53A Servo/PST Ø15 mm. Nederste/Lower/Unten		
5	5113006 V/H - L/R Stabilisatorstang/Stabilizer rod/Diagonalstrebe	88 mm.		
6	5033023 V/H - L/R (**) Styrestang/Tie rod end/Axialgelenk			
				(**) Med Servostyring With Power Steering Mit Servolenkung









POS	 Colt IV CA Serie 4/92-4/96				
Foraksel/Front axle/Vorneachse					
1	5013005 Venstre/Left/Links Bærearmlenke/Track control arm/Querlenker	Nederste/Lower/Unten			
2	5013006 Højre/Right/Rechs Bærearmlenke/Track control arm/Querlenker	Nederste/Lower/Unten			
3	5033014 V/H - L/R Styreknude/Tie rod end/Kugelgelenk	12x1,25 RHT Yderste/Outer/Außen			
4	5033023 V/H - L/R (**) Styrestang/Tie rod end/Axialgelenk	12x1,25 RHT Inderste/Inner			
5	5093002 (**) Manchetsæt/Boot kit/Manschetten satz				
6	5114507 V/H - L/R Stabilisatorbolt/Stabilizer bolt/Stabilisator bolzen	61 mm.			
Bagaksel/Rear axle/Hinterachse					
7	5013007 Venstre/Left/Links Bærearmlenke/Track control arm/Querlenker	Nederste/Lower/Unten			
8	5013008 Højre/Right/Rechs Bærearmlenke/Track control arm/Querlenker	Nederste/Lower/Unten			
9	5013009 Venstre/Left/Links Bærearmlenke/Track control arm/Querlenker	Øverst/Upper/Oben			
10	5013010 Højre/Right/Rechs Bærearmlenke/Track control arm/Querlenker	Øverst/Upper/Oben			(**) Med Servostyring With Power Steering Mit Servolenkung
POS	 Colt V CJ Serie 5/96-				
Foraksel/Front axle/Vorneachse					
1	5033014 V/H - L/R Styreknude/Tie rod end/Kugelgelenk	12x1,25 RHT Yderste/Outer/Außen			
2	5033023 V/H - L/R (**) Styrestang/Tie rod end/Axialgelenk	12x1,25 RHT Inderste/Inner			
3	5043009 V/H - L/R Bærekugle/Ball joint/Radgelenk	Ø15 mm. Nederste/Lower/Unten			
4	5093002 (**) Manchetsæt/Boot kit/Manschetten satz				
5	5113008 V/H - L/R Stabilisatorstang/Stabilizer rod/Diagonalstrebe	130 mm.			
(**) Med Servostyring With Power Steering Mit Servolenkung					



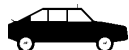

POS	 Cordia A211A, A212A 10/82-12/86
Foraksel/Front axle/Vorneachse	
1	<p>5033012 V/H - L/R Styrekugle/Tie rod end/Kugelgelenk 14x1,5 RHT Konus/Cone 13,2 mm. Yderste/Outer/Außen</p>  1
2	<p>5033017 V/H - L/R (*) Styrekugle/Tie rod end/Axialgelenk 14x1,5 RHT Inderste/Inner</p>  2
3	<p>5043009 V/H - L/R Bærekugle/Ball joint/Radgelenk Ø15 mm. Nederste/Lower/Unten</p>  3
(*) Uden servostyring Without Power Steering Ohne Servolenkung	
POS	 Eclipse I 4/91-11/95
Foraksel/Front axle/Vorneachse	
1	<p>5033012 V/H - L/R Styrekugle/Tie rod end/Kugelgelenk 14x1,5 RHT Konus/Cone 13,2 mm. Yderste/Outer/Außen</p>  1
2	<p>5113007 V/H - L/R Stabilisator/Stabilizer/Stabilisator 120 mm. Stabilisator</p>  2











POS	 Eclipse II 12/95-
Foraksel/Front axle/Vorneachse	
1	<p>5033012 V/H - L/R 14x1,5 RHT Konus/Cone 13,2 mm.  1</p> <p>Styrekugle/Tie rod end/Kugelgelenk Yderste/Outer/Außen</p>
2	<p>5113007 V/H - L/R 120 mm.  2</p> <p>Stabilisator/Stabilizer/Stabilisator</p>
POS	 Galant I A121A, A121V, A122A, A123A, A123V, A131A, A133A 5/76-1980
Foraksel/Front axle/Vorneachse	
1	<p>5033003 V/H - L/R 14x1,5 LHT  1</p> <p>Styrekugle/Tie rod end/Kugelgelenk Yderste/Outer/Außen</p>
2	<p>5043003 V/H - L/R  2</p> <p>Bærekugle/Ball joint/Radgelenk</p>



POS	 Galant II A161A, A162A 4/80-5/84
Foraksel/Front axle/Vorneachse	
1	<p>5033003 V/H - L/R Styrekugle/Tie rod end/Kugelgelenk 14x1,5 LHT Yderste/Outer/Außen</p>  1
2	<p>5043003 V/H - L/R Bærekugle/Ball joint/Radgelenk Nederste/Lower/Unten</p>  2
POS	 Galant II A161V 9/80-5/84
Foraksel/Front axle/Vorneachse	
1	<p>5033003 V/H - L/R Styrekugle/Tie rod end/Kugelgelenk 14x1,5 LHT Yderste/Outer/Außen</p>  1
2	<p>5043003 V/H - L/R Bærekugle/Ball joint/Radgelenk Nederste/Lower/Unten</p>  2











POS	Galant III E11A, E12A, E13A, E15A, E16A 6/84-12/87
Foraksel/Front axle/Vorneachse	
1	<p>5033012 V/H - L/R 14x1,5 RHT Konus/Cone 13,2 mm.  1</p> <p>Styrekugle/Tie rod end/Kugelgelenk Yderste/Outer/Außen</p>
2	<p>5033017 V/H - L/R (*) 14x1,5 RHT  2</p> <p>Styrekugle/Tie rod end/Axialgelenk Inderste/Inner</p>
3	<p>5043009 V/H - L/R Ø15 mm.  3</p> <p>Bærekugle/Ball joint/Radgelenk Nederste/Lower/Unten</p>
4	<p>5113204 V/H - L/R 130 mm.  4</p> <p>Stabilisatorbolt/Stabilizer bolt/Stabilisator bolzen</p>
(*) Uden servostyring Without Power Steering Ohne Servolenkung	
POS	Galant IV E31A, E32A, E33A, E38A, E39A 11/87-10/92
Foraksel/Front axle/Vorneachse	
1	<p>5033012 V/H - L/R 14x1,5 RHT Konus/Cone 13,2 mm.  1</p> <p>Styrekugle/Tie rod end/Kugelgelenk Yderste/Outer/Außen</p>
2	<p>5033017 V/H - L/R 14x1,5 RHT  2</p> <p>Styrekugle/Tie rod end/Axialgelenk Inderste/Inner</p>
3	<p>5043009 V/H - L/R Ø15 mm.  3</p> <p>Bærekugle/Ball joint/Radgelenk Nederste/Lower/Unten</p>
4	<p>5093002  4</p> <p>Manchetsæt/Boot kit/Manschetten satz</p>
5	<p>5114507 V/H - L/R 61 mm.  5</p> <p>Stabilisatorstang/Stabilizer rod/Diagonalstrebe</p>







POS		Galant Sigma II A163A, A164A, A166A, A167A 4/80-1984 & Galant Sigma II A168V 11/81-1986
Foraksel/Front axle/Vorneachse		
1	5033003 V/H - L/R Styrekugle/Tie rod end/Kugelgelenk	14x1,5 LHT Yderste/Outer/Außen  1
Foraksel/Front axle/Vorneachse		
POS		Galant V E52A, E54A, E55A, E57A, E75A, E88A 11/92-8/96
Foraksel/Front axle/Vorneachse		
1	5033012 V/H - L/R Styrekugle/Tie rod end/Kugelgelenk	14x1,5 RHT Konus/Cone 13,2 mm. Yderste/Outer/Außen  1
2	5043009 V/H - L/R Bærekugle/Ball joint/Radgelenk	Ø15 mm. Nederste/Lower/Unten  2
3	5093002 Manchetsæt/Boot kit/Manschetten satz	 3
4	5113007 V/H - L/R 120 mm. Stabilisator/Stabilizer/Stabilisator	 4
Bagaksel/Rear axle/Hinterachse		
5	5114507 V/H - L/R Stabilisatorstang/Stabilizer rod/Diagonalstrebe	61 mm.  5









POS	 Galant VI EA_ 9/96-	
Foraksel/Front axle/Vorneachse		
1	5033012 V/H - L/R Styrekugle/Tie rod end/Kugelgelenk	14x1,5 RHT Konus/Cone 13,2 mm. Yderste/Outer/Außen  1
2	5093002 Manchetsæt/Boot kit/Manschetten satz	 2
3	5113007 V/H - L/R 120 mm. Stabilisator/Stabilizer/Stabilisator	 3
POS	 Galloper JK-01 2/99-	

POS	 L 200 K12T/K14T 2WD 11/86-8/96 & L 200 LO Serie, 2WD 8/80-12/82
Foraksel/Front axle/Vorneachse	
1	<p>5033003 V/H - L/R Styrekugle/Tie rod end/Kugelgelenk 14x1,5 LHT Yderste/Outer/Außen</p> 
2	<p>5033015 Højre/Right/Rechs Styrekugle/Tie rod end/Axialgelenk 14x1,5 LHT Inderste/Inner</p> 
3	<p>5043006 V/H - L/R Bærekugle/Ball joint/Radgelenk Nederste/Lower/Unten</p> 
4	<p>5043007 V/H - L/R Bærekugle/Ball joint/Radgelenk Øverste/Upper/Oben</p> 
5	<p>5112205 V/H - L/R Stabilisatorbolt/Stabilizer bolt/Stabilisator bolzen 140 mm.</p> 
POS	 L 200 K22T/K24T/K34T 4WD 11/86-8/96 & L 200 LO Serie, 4WD 9/80-12/82
Foraksel/Front axle/Vorneachse	
1	<p>5033007 V/H - L/R Styrekugle/Tie rod end/Kugelgelenk 16x1,5 LHT Konus/Cone 13,7 mm. Yderste/Outer/Außen</p> 
2	<p>5033008 V/H - L/R Styrekugle/Tie rod end/Axialgelenk 16x1,5 RHT Konus/Cone 13,7 mm. Inderste/Inner</p> 
3	<p>5043007 V/H - L/R Bærekugle/Ball joint/Radgelenk Øverste/Upper/Oben</p> 
4	<p>5043008 V/H - L/R Bærekugle/Ball joint/Radgelenk Nederste/Upper/Oben</p> 

POS	 L 200 K6_T 6/96-
POS	 L 300 LO Serie 2WD 10/82-4/94
Foraksel/Front axle/Vorneachse	
1	<p>5033012 V/H - L/R Styrekugle/Tie rod end/Kugelgelenk</p> <p>14x1,5 RHT Konus/Cone 13,2 mm. Yderste/Outer/Außen</p>
2	<p>5033018 V/H - L/R Styrekugle/Tie rod end/Axialgelenk</p> <p>14x1,5 LHT Konus/Cone 13,2 mm. Inderste/Inner</p>
3	<p>5043006 V/H - L/R Bærekugle/Ball joint/Radgelenk</p> <p>10/83- Nederste/Lower/Unten</p>
4	<p>5043007 V/H - L/R Bærekugle/Ball joint/Radgelenk</p> <p>10/83- Øverste/Upper/Oben</p>
	 1  2  3  4

POS	 L 300 LO Serie, 4WD 10/82-2/87
Foraksel/Front axle/Vorneachse	
1	<p>5033007 V/H - L/R Styrekugle/Tie rod end/Kugelgelenk 16x1,5 LHT Konus/Cone 13,7 mm. Yderste/Outer/Außen</p>  1
2	<p>5033008 V/H - L/R Styrekugle/Tie rod end/Kugelgelenk 16x1,5 LHT Konus/Cone 13,7 mm. Inderste styrekugle</p>  2
3	<p>5043007 V/H - L/R Bærekugle/Ball joint/Radgelenk Øverste/Upper/Oben</p>  3
4	<p>5043008 V/H - L/R Bærekugle/Ball joint/Radgelenk Nederste bærekugle</p>  4
POS	 L 300 2WD PO1V, PO2V, PO5V, P12V, P15V, PO3W, PO5W, P15W 6/86-
Foraksel/Front axle/Vorneachse	
1	<p>5033017 V/H - L/R (**) Styrekugle/Tie rod end/Axialgelenk 14x1,5 RHT Inderste/Inner</p>  1
2	<p>5033022 V/H - L/R (*) Styrekugle/Tie rod end/Axialgelenk 14x1,5 RHT Inderste/Inner</p>  2
3	<p>5033021 V/H - L/R (*) Styrekugle/Tie rod end/Kugelgelenk 14x1,5 RHT Yderste/Outer/Außen</p>  3
4	<p>5043010 V/H - L/R Bærekugle/Ball joint/Radgelenk Nederste/Lower/Unten</p>  4
5	<p>5043011 V/H - L/R Bærekugle/Ball joint/Radgelenk Øverste/Upper/Oben</p>  5
<p>(*) Uden servostyring Without Power Steering Ohne Servolenkung</p> <p>(**) Med Servostyring With Power Steering Mit Servolenkung</p>	



POS	 L 300 4WD P23V, P25V, P23W, P25W 6/86-
Foraksel/Front axle/Vorneachse	
1	<p>5033021 V/H - L/R 14x1,5 RHT Konus/Cone 13,5 mm.  1</p> <p>Styrekugle/Tie rod end/Kugelgelenk Yderste/Outer/Außen</p>
2	<p>5043011 V/H - L/R  2</p> <p>Bærekugle/Ball joint/Radgelenk Øverste/Upper/Oben</p>
POS	 L 400 P-Serie 5/95-
Foraksel/Front axle/Vorneachse	
1	<p>5033021 V/H - L/R 14x1,5 RHT Konus/Cone 13,5 mm.  1</p> <p>Styrekugle/Tie rod end/Kugelgelenk Yderste/Outer/Außen</p>
2	<p>5033022 V/H - L/R (*) 14x1,5 RHT  2</p> <p>Styrekugle/Tie rod end/Axialgelenk Inderste/Inner</p>
<p>(*) Uden servostyring Without Power Steering Ohne Servolenkung</p>	



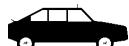



POS	 Lancer I A171A, A172A, A174A & A176A 4/79-1/84
Foraksel/Front axle/Vorneachse	
1	<p>5033003 V/H - L/R 14x1,5 LHT  1</p> <p>Styrekugle/Tie rod end/Kugelgelenk Yderste/Outer/Außen</p>
2	<p>5043003 V/H - L/R  2</p> <p>Bærekugle/Ball joint/Radgelenk Nederste/Lower/Unten</p>
POS	 Lancer F II A155A, A156A 2/82-9/83
Foraksel/Front axle/Vorneachse	
1	<p>5033001 V/H - L/R 14x1,5 RHT  1</p> <p>Styrekugle/Tie rod end/Kugelgelenk Yderste/Outer/Außen</p>
3	<p>5043001 U Venstre/Left/Links  2</p> <p>Bærekugle/Ball joint/Radgelenk Nederste/Lower/Unten</p>
4	<p>5043002 U Højre/Right/Rechs  4</p> <p>Bærekugle/Ball joint/Radgelenk Nederste/Lower/Unten</p>
5	<p>5113002 V/H - L/R 140 mm.  5</p> <p>Stabilisatorbolt/Stabilizer bolt/Stabilisator bolzen</p>







POS	Lancer III C11A - C37W 10/83-6/92			
Foraksel/Front axle/Vorneachse				
1	5013001 U Venstre/Left/Links Bærearmlenke/Track control arm/Querlenker	Nederste/Lower/Unten		
2	5013002 U Højre/Right/Rechs Bærearmlenke/Track control arm/Querlenker	Nederste/Lower/Unten		
3	5033010 U V/H - L/R -12/85 Styrekugle/Tie rod end/Kugelgelenk	14x1,5 RHT Konus/Cone 13,4 mm. Yderste/Outer/Außen		
4	5033014 V/H - L/R 1/86- Styrekugle/Tie rod end/Kugelgelenk	12x1,25 RHT Yderste/Outer/Außen		
5	5043003 V/H - L/R Bærekugle/Ball joint/Radgelenk	Nederste/Lower/Unten		
6	5113002 V/H - L/R -1/86 Stabilisatorbolt/Stabilizer bolt/Stabilisator bolzen	140 mm.		
POS	Lancer IV C61A, C62A, C64A, C66A, C68A, C69A, C77A 4/88-5/94			
Foraksel/Front axle/Vorneachse				
1	5013005 Venstre/Left/Links Bærearmlenke/Track control arm/Querlenker	(1,5 C62A) Nederste/Lower/Unten		
2	5013006 Højre/Right/Rechs Bærearmlenke/Track control arm/Querlenker	(1,5 C62A) Nederste/Lower/Unten		
3	5013011 Venstre/Left/Links Bærearmlenke/Track control arm/Querlenker	(Excl. 1,5 C62A) Nederste/Lower/Unten		
4	5013012 Højre/Right/Rechs Bærearmlenke/Track control arm/Querlenker	(Excl. 1,5 C62A) Nederste/Lower/Unten		
5	5033014 V/H - L/R Styrekugle/Tie rod end/Kugelgelenk	12x1,25 RHT Yderste/Outer/Außen		
7	5043009 V/H - L/R Bærekugle/Ball joint/Radgelenk	Ø15 mm. Nederste/Lower/Unten		
8	5113006 V/H - L/R Stabilisatorstang/Stabilizer rod/Diagonalstrebe	(Excl. 1,5 C62A) 88 mm.		
9	5114507 V/H - L/R Stabilisatorstang/Stabilizer rod/Diagonalstrebe	(1,5 C62A) 61 mm.		





POS	 Lancer V CB Serie 6/92- & Lancer V Kombi CA_W 12/92- 6/92-
Foraksel/Front axle/Vorneachse	
1	5013005 Venstre/Left/Links Bærearmlenke/Track control arm/Querlenker Nederste/Lower/Unten
2	5013006 Højre/Right/Rechs Bærearmlenke/Track control arm/Querlenker Nederste/Lower/Unten
3	5033014 V/H - L/R Styrekugle/Tie rod end/Kugelgelenk 12x1,25 RHT Yderste/Outer/Außen
4	5033023 V/H - L/R Styrekugle/Tie rod end/Axialgelenk 12x1,25 RHT Inderste/Inner
5	5114507 V/H - L/R Stabilisatorstang/Stabilizer rod/Diagonalstrebe 61 mm.
Bagaksel/Rear axle/Hinter achse	
6	5013007 Venstre/Left/Links Bærearmlenke/Track control arm/Querlenker Nederste/Lower/Unten
7	5013008 Højre/Right/Rechs Bærearmlenke/Track control arm/Querlenker Nederste/Lower/Unten
8	5013009 Venstre/Left/Links Bærearmlenke/Track control arm/Querlenker Øverst/Upper/Oben
9	5013010 Højre/Right/Rechs Bærearmlenke/Track control arm/Querlenker Øverst/Upper/Oben
POS	 Lancer VI CJ_Serie 12/95-
Foraksel/Front axle/Vorneachse	
1	5033014 V/H - L/R Styrekugle/Tie rod end/Kugelgelenk 12x1,25 RHT Yderste/Outer/Außen
2	5113008 V/H - L/R Stabilisatorstang/Stabilizer rod/Diagonalstrebe 130 mm.



mitsubishi





POS	 Lancer 9/03-
	Foraksel/Front axle/Vorneachse
1	5113008 V/H - L/R 130 mm. Stabilisatorstang/Stabilizer rod/Diagonalstrebe
POS	 Outlander 5/03-





POS	Pajero Classic V2_W 7/02-
POS	Pajero I LO41G, LO43G, LO44G, LO46G, LO48G, LO49G 4/82-12/91
	Foraksel/Front axle/Vorneachse
1	<p>5033007 V/H - L/R 16x1,5 LHT Konus/Cone 13,7 mm.  1 Styrekugle/Tie rod end/Kugelgelenk Yderste/Outer/Außen</p>
2	<p>5033008 V/H - L/R 16x1,5 RHT Konus/Cone 13,7 mm.  2 Styrekugle/Tie rod end/Axialgelenk Inderste/Inner</p>
3	<p>5043007 V/H - L/R  3 Bærekugle/Ball joint/Radgelenk Øverste/Upper/Oben</p>
4	<p>5043008 V/H - L/R  4 Bærekugle/Ball joint/Radgelenk Nederste/Lower/Unten</p>
5	<p>5113003 U V/H - L/R 120 mm.  5 Stabilisatorbolt/Stabilizer bolt/Stabilisator bolzen</p>
6	<p>5113004 V/H - L/R 60 mm.  6 Stabilisatorbolt/Stabilizer bolt/Stabilisator bolzen</p>
	Bagaksel/Rear axle/Hinterachse
7	<p>5113005 V/H - L/R 110 mm.  7 Stabilisatorbolt/Stabilizer bolt/Stabilisator bolzen</p>











POS	 Pajero II V-Serie 12/90-4/00
Foraksel/Front axle/Vorneachse	
1	<p>5033019 V/H - L/R Styrekugle/Tie rod end/Kugelgelenk 16x1,5 RHT Yderste/Outer/Außen</p>  1
2	<p>5043012 V/H - L/R Bærekugle/Ball joint/Radgelenk Øverste/Upper/Oben</p>  2
3	<p>5043013 Venstre/Left/Links Bærekugle/Ball joint/Radgelenk Nederste/Lower/Unten</p>  3
4	<p>5043014 Højre/Right/Rechs Bærekugle/Ball joint/Radgelenk Nederste/Lower/Unten</p>  4
POS	 Pajero III V60 4/00-
Foraksel/Front axle/Vorneachse	
1	<p>5043012 V/H - L/R Bærekugle/Ball joint/Radgelenk Øverste/Upper/Oben</p>  1

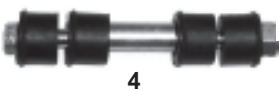











POS	 Pajero Pinin 10/99-
Foraksel/Front axle/Vorneachse	
1	<p>5033012 V/H - L/R 14x1,5 RHT Konus/Cone 13,2 mm.  1</p> <p>Styrekugle/Tie rod end/Kugelgelenk Yderste/Outer/Außen</p>
2	<p>5114507 V/H - L/R 61 mm.  2</p> <p>Stabilisatorstang/Stabilizer rod/Diagonalstrebe</p>
POS	 Pajero Sport K90 11/98-



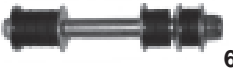



POS	Sapporo A123/A1643/A164 4/78-8/84
Foraksel/Front axle/Vorneachse	
1	<p>5033003 V/H - L/R 14x1,5 LHT  1</p> <p>Styrekugle/Tie rod end/Kugelgelenk Yderste/Outer/Außen</p>
2	<p>5043009 V/H - L/R Ø15 mm.  2</p> <p>Bærekugle/Ball joint/Radgelenk Nederste/Lower/Unten</p>
POS	Sapporo E16A 6/87-8/90
Foraksel/Front axle/Vorneachse	
1	<p>5043009 V/H - L/R Ø15 mm.  1</p> <p>Bærekugle/Ball joint/Radgelenk Nederste/Lower/Unten</p>



POS	 Sigma F16A 12/90-7/96
Foraksel/Front axle/Vorneachse	
1	<p>5033012 V/H - L/R 14x1,5 RHT Konus/Cone 13,2 mm.  1</p> <p>Styrekugle/Tie rod end/Kugelgelenk Yderste/Outer/Außen</p>
2	<p>5043009 V/H - L/R Ø15 mm.  2</p> <p>Bærekugle/Ball joint/Radgelenk Nederste/Lower/Unten</p>
POS	 Space Gear P-Serie 5/95-
Foraksel/Front axle/Vorneachse	
1	<p>5033019 V/H - L/R 16x1,5 RHT  1</p> <p>Styrekugle/Tie rod end/Kugelgelenk Yderste/Outer/Außen</p>

POS	 Space Runner N11W - N21W 10/91-8/99
Foraksel/Front axle/Vorneachse	
1	<p>5033012 V/H - L/R 14x1,5 RHT Konus/Cone 13,2 mm.  1</p> <p>Styrekugle/Tie rod end/Kugelgelenk Yderste/Outer/Außen</p>
2	<p>5043009 V/H - L/R Ø15 mm.  2</p> <p>Bærekugle/Ball joint/Radgelenk Nederste/Lower/Unten</p>
3	<p>5093002</p> <p>Manchetsæt/Boot kit/Manschetten satz</p>
POS	 Space Runner N50 8/99-

POS	Space Star DG0 6/98-
Foraksel/Front axle/Vorneachse	
1	<p>5033014 V/H - L/R 12x1,25 RHT  1 Styrekugle/Tie rod end/Kugelgelenk Yderste/Outer/Außen</p>
2	<p>5043009 V/H - L/R Ø15 mm.  2 Bærekugle/Ball joint/Radgelenk Nederste/Lower/Unten</p>
3	<p>5093002 Manchetsæt/Boot kit/Manschetten satz</p>
4	<p>5113008 V/H - L/R  4 Stabilisator bolt/Stabilizer bolt/Stabilisator bolzen</p>
Bagaksel/Rear axle/Hinterachse	
5	<p>5114805 V/H - L/R 105 mm.  5 Stabilisator/Stabilizer/Stabilisator</p>
Foraksel/Front axle/Vorneachse	
1	<p>5033012 V/H - L/R 14x1,5 RHT Konus/Cone 13,2 mm.  1 Styrekugle/Tie rod end/Kugelgelenk Yderste/Outer/Außen</p>
2	<p>5033017 V/H - L/R 14x1,5 RHT  2 Styrekugle/Tie rod end/Axialgelenk Inderste/Inner</p>
3	<p>5043009 Ø15 mm.  3 Bærekugle/Ball joint/Radgelenk Nederste/Lower/Unten</p>
4	<p>5093002 Manchetsæt/Boot kit/Manschetten satz</p>
5	<p>5113009 Venstre/Left/Links 55 mm.  5 Stabilisator/Stabilizer/Stabilisator</p>
6	<p>5113010 Højre/Right/Rechs  6 Stabilisator/Stabilizer/Stabilisator</p>
Bagaksel/Rear axle/Hinterachse	
7	<p>5113011 V/H - L/R 140 mm.  8 Stabilisatorbolt/Stabilizer bolt/Stabilisator bolzen</p>







POS	 Space Wagon D0_V/W 4WD 3/85-4/91
Foraksel/Front axle/Vorneachse	
1	<p>5033012 V/H - L/R 14x1,5 RHT Konus/Cone 13,2 mm.  1 Styrekugle/Tie rod end/Kugelgelenk Yderste/Outer/Außen</p>
2	<p>5033017 V/H - L/R 14x1,5 RHT  2 Styrekugle/Tie rod end/Axialgelenk Inderste/Inner</p>
3	<p>5093002 Manchetsæt/Boot kit/Manschetten satz  3</p>
4	<p>5113009 Venstre/Left/Links 55 mm.  4 Stabilisator/Stabilizer/Stabilisator</p>
5	<p>5113010 Højre/Right/Rechs 55 mm.  5 Stabilisator/Stabilizer/Stabilisator</p>
Bagaksel/Rear axle/Hinterachse	
6	<p>5113011 V/H - L/R 140 mm.  6 Stabilisatorbolt/Stabilizer bolt/Stabilisator bolzen</p>
POS	 Space Wagon N3_W - N4_W 10/91-10/98
Foraksel/Front axle/Vorneachse	
1	<p>5033012 V/H - L/R 14x1,5 RHT Konus/Cone 13,2 mm.  1 Styrekugle/Tie rod end/Kugelgelenk Yderste/Outer/Außen</p>
2	<p>5093002 Manchetsæt/Boot kit/Manschetten satz  2</p>
3	<p>5113009 Venstre/Left/Links 55 mm.  3 Stabilisator/Stabilizer/Stabilisator</p>
4	<p>5113010 Højre/Right/Rechs 55 mm.  4 Stabilisator/Stabilizer/Stabilisator</p>
Bagaksel/Rear axle/Hinterachse	
5	<p>5113011 V/H - L/R 140 mm.  5 Stabilisatorbolt/Stabilizer bolt/Stabilisator bolzen</p>

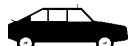



POS	 Space Wagon N5_W 10/98-
Foraksel/Front axle/Vorneachse	
1	<p>5033012 V/H - L/R 14x1,5 RHT Konus/Cone 13,2 mm.  1 Styrekugle/Tie rod end/Kugelgelenk Yderste/Outer/Außen</p>
2	<p>5113009 Venstre/Left/Links 55 mm.  2 Stabilisator/Stabilizer/Stabilisator</p>
3	<p>5113010 Højre/Right/Rechs 55 mm.  3 Stabilisator/Stabilizer/Stabilisator</p>
POS	 Starion A182A, A183A 4/82-8/87
Foraksel/Front axle/Vorneachse	
1	<p>5033003 V/H - L/R 14x1,5 LHT  1 Styrekugle/Tie rod end/Kugelgelenk Yderste/Outer/Außen</p>









POS	Tredia A213A 10/82-10/87
Foraksel/Front axle/Vorneachse	
1	<p>5033012 V/H - L/R Styrekugle/Tie rod end/Kugelgelenk</p> <p>14x1,5 RHT Konus/Cone 13,2 mm. Yderste/Outer/Außen</p> 
2	<p>5033017 V/H - L/R (*) Styrekugle/Tie rod end/Axialgelenk</p> <p>14x1,5 RHT Inderste/Inner</p> 
3	<p>5043009 V/H - L/R Bærekugle/Ball joint/Radgelenk</p> <p>Ø15 mm. Nederste/Lower/Unten</p> 
<p>(*) Uden servostyring Without Power Steering Ohne Servolenkung</p>	
POS	

mitsubishi









POS	
POS	







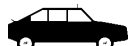

POS	 100 NX B13 3/90-10/94
Foraksel/Front axle/Vorneachse	
1	<p>5032240 V/H - L/R 12x1,25  1</p> <p>Styrekugle/Tie rod end/Kugelgelenk Yderste/Outer/Außen</p>
2	<p>5032260 V/H - L/R 12x1,25 RHT  2</p> <p>Styrekugle/Tie rod end/Axialgelenk Inderste/Inner</p>
3	<p>5042230 V/H - L/R  3</p> <p>Bærekugle/Ball joint/Radgelenk Nederste/Lower/Unten</p>
4	<p>5112208 V/H - L/R 85 mm.  4</p> <p>Stabilisatorbolt/Stabilizer bolt/Stabilisator bolzen</p>
POS	 200 SX/ZX S13/S14 9/88-
Foraksel/Front axle/Vorneachse	
1	<p>5032205 V/H - L/R 12x1,25/16x1  1</p> <p>Styrekugle/Tie rod end/Axialgelenk Inderste/Inner</p>





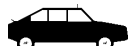



POS	 280 C 430 1979-83		
Foraksel/Front axle/Vorneachse			
1	5042210 V/H - L/R Bærekugle/Ball joint/Radgelenk	Øverste/Upper/Oben	 1
POS	 300 ZX (Z32) 5/90-9/95		
Foraksel/Front axle/Vorneachse			
1	5032253 V/H - L/R Styrekugle/Tie rod end/Axialgelenk	Inderste/Inner	 1





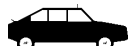







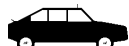

POS	Almera I N15 9/95-7/00
Foraksel/Front axle/Vorneachse	
1	5012217 Venstre/Left/Links Bæream/Track control arm/Querlenker Nederste/Lower/Unten  
2	5012218 Højre/Right/Rechs Bæream/Track control arm/Querlenker Nederste/Lower/Unten
3	5032258 V/H - L/R Styrekugle/Tie rod end/Kugelgelenk 12x1,25 RHT Konus/Cone 13 mm. Yderste/Outer/Außen 
4	5032260 V/H - L/R Styrekugle/Tie rod end/Axialgelenk 12x1,5 RHT Inderste/Inner 
5	5042230 V/H - L/R Bærekugle/Ball joint/Radgelenk Øverste/Upper/Oben 
6	5092206 manchetsæt/Boot kit/Manschetten satz
7	5102201 For/Front/Vorne Bøsning/Bushing/Buchsen V/H - L/R 
8	5102202 Bag/Rear/Hinten Bøsning/Bushing/Buchsen V/H - L/R 
9	5112208 V/H - L/R Stabilisatorbolt/Stabilizer bolt/Stabilisator bolzen 85 mm. 
POS	
Bagaksel/Rear axle/Hinterachse	
10	5112209 V/H - L/R Stabilisator/Stabilizer/Stabilisator 171 mm. 

POS	Almera II N16 7/00-
Foraksel/Front axle/Vorneachse	
1	5012219 Venstre/Left/Links Bærearml/Track control arm/Querlenker Nederste/Lower/Unten
2	5012220 Højre/Right/Rechs Bærearml/Track control arm/Querlenker Nederste/Lower/Unten
3	5032262 V/H - L/R 12x1,25 Styrekugle/Tie rod end/Kugelgelenk Yderste/Outer/Außen
4	5032272 V/H - L/R Styrekugle/Tie rod end/Axialgelenk Inderste/Inner
5	5092206 Manchetsæt/Boot kit/Manschetten satz
6	5112210 V/H - L/R Stabilisatorstang/Stabilizer rod/Diagonalstrebe
POS	Bluebird U11 4/84-12/90
Foraksel/Front axle/Vorneachse	
1	5032205 V/H - L/R 12x1,25/16x1 Styrekugle/Tie rod end/Axialgelenk Inderste/Inner
2	5032240 V/H - L/R 12x1,25 Styrekugle/Tie rod end/Kugelgelenk Yderste/Outer/Außen
3	5042229 V/H - L/R Bærekugle/Ball joint/Radgelenk Nederste/Lower/Unten
4	5092203 (*) Manchetsæt/Boot kit/Manschetten satz
5	5112208 V/H - L/R 85 mm. Stabilisatorbolt/Stabilizer bolt/Stabilisator bolzen
(*) Uden servostyring Without Power Steering Ohne Servolenkung	







POS	 Bluebird T12/T72 12/85-12/90
Foraksel/Front axle/Vorneachse	
1	<p>5032205 V/H - L/R 12x1,25/16x1 Styrekugle/Tie rod end/Axialgelenk Inderste/Inner</p> 
2	<p>5032240 V/H - L/R -12/87 12x1,25 Styrekugle/Tie rod end/Kugelgelenk Yderste/Outer/Außen</p> 
3	<p>5042229 V/H - L/R Bærekugle/Ball joint/Radgelenk Nederste/Lower/Unten</p> 
4	<p>5092204 12/87- (**) Manchetsæt/Boot kit/Manschetten satz</p> 
5	<p>5112208 V/H - L/R 85 mm. Stabilisatorbolt/Stabilizer bolt/Stabilisator bolzen</p> 
(**) Med servostyring With Power Steering Mit Servolenkung	
POS	 Cherry FII N10 10/78-12/83
Foraksel/Front axle/Vorneachse	
1	<p>5042202 U V/H - L/R Bærekugle/Ball joint/Radgelenk Nederste/Lower/Unten</p> 
2	<p>5112201 U V/H - L/R 100 mm. Stabilisatorbolt/Stabilizer bolt/Stabilisator bolzen</p> 

POS	 Cherry N12 4/82-10/86
Foraksel/Front axle/Vorneachse	
1	5032204 V/H - L/R Styrekugle/Tie rod end/Kugelgelenk 12x1,25 Yderste/Outer/Außen  1
2	5032205 V/H - L/R Styrekugle/Tie rod end/Axialgelenk 12x1,25/16x1 Inderste/Inner  2
3	5042203 V/H - L/R Bærekugle/Ball joint/Radgelenk Nederste/Lower/Unten  3
4	5112201 U V/H - L/R Stabilisatorbolt/Stabilizer bolt/Stabilisator bolzen  4
POS	 King Cab 720 - Pick-Up 4WD 4/80-3/83
Foraksel/Front axle/Vorneachse	
1	5032245 V/H - L/R Styrekugle/Tie rod end/Kugelgelenk 18x1,5 Yderste/Outer/Außen  1
2	5042210 V/H - L/R Bærekugle/Ball joint/Radgelenk Øverste/Upper/Oben  2
3	5042216 U Venstre/Left/Links Bærekugle/Ball joint/Radgelenk Nederste/Lower/Unten  3
4	5112206 U V/H - L/R 210 mm. Stabilisatorbolt/Stabilizer rod/Stabilisator bolzen  4







POS	 King Cab 720 - Pick-Up 4WD 4/83-7/85
Foraksel/Front axle/Vorneachse	
1	<p>5042210 V/H - L/R Bærekugle/Ball joint/Radgelenk Øverste/Upper/Oben</p>  1
2	<p>5042220 V/H - L/R Bærekugle/Ball joint/Radgelenk Nederste/Lower/Unten</p>  2
3	<p>5112203 U V/H - L/R Stabilisatorbolt/Stabilizer bolt/Stabilisator bolzen</p>  3
POS	 King Cab 720 - Pick-Up 720 2WD 9/79-7/85
Foraksel/Front axle/Vorneachse	
1	<p>5032245 V/H - L/R 18x1,5 Styrekugle/Tie rod end/Kugelgelenk Yderste/Outer/Außen</p>  1
2	<p>5042210 V/H - L/R Bærekugle/Ball joint/Radgelenk Øverste/Upper/Oben</p>  2
3	<p>5042216 U Venstre/Left/Links Bærekugle/Ball joint/Radgelenk Nederste/Lower/Unten</p>  3
4	<p>5112206 U V/H - L/R 210 mm. Stabilisatorbolt/Stabilizer bolt/Stabilisator bolzen</p>  4





POS	 King Cab D21 - Pick-Up D21 2WD 8/85-2/98
Foraksel/Front axle/Vorneachse	
1	5032245 V/H - L/R Styrekugle/Tie rod end/Kugelgelenk 18x1,5 Yderste/Outer/Außen  1
2	5032246 V/H - L/R Styrekugle/Tie rod end/Axialgelenk 18x1,5 Inderste/Inner  2
3	5042210 V/H - L/R Bærekugle/Ball joint/Radgelenk Øverste/Upper/Oben  3
4	5042225 V/H - L/R Bærekugle/Ball joint/Radgelenk Nederste/Lower/Unten  4
5	5112204 V/H - L/R Stabilisatorbolt/Stabilizer rod/Stabilisator bolzen 190 mm.  5
POS	 King Cab D21 - Pick-Up D21 4WD 8/85-2/98
Foraksel/Front axle/Vorneachse	
1	5032247 V/H - L/R (*) Styrekugle/Tie rod end/Kugelgelenk 16x1,5 Yderste/Outer/Außen  1
2	5032248 V/H - L/R (*) Styrekugle/Tie rod end/Axialgelenk 16x1,5 Inderste/Inner  2
3	5032263 V/H - L/R (**) Styrekugle/Tie rod end/Kugelgelenk 16x1,5 RHT Yderste/Outer/Außen  3
4	5032264 V/H - L/R (**) Styrekugle/Tie rod end/Axialgelenk 16x1,5 RHT Konus/Cone 14,4 mm. Inderste/Inner  4
5	5042210 V/H - L/R Bærekugle/Ball joint/Radgelenk Øverste/Upper/Oben  5
6	5042220 V/H - L/R Bærekugle/Ball joint/Radgelenk Nederste/Lower/Unten  6
7	5112205 V/H - L/R Stabilisatorbolt/Stabilizer bolt/Stabilisator bolzen 140 mm.  7

















POS	King van E24 9/86-
Foraksel/Front axle/Vorneachse	
1	5032256 Venstre/Left/Links Styrekugle/Tie rod end/Axialgelenk -9/88 16x1,5 RHT Inderste/Inner
2	5032257 Højre/Right/Rechs Styrekugle/Tie rod end/Axialgelenk -9/88 16x1,5 LHT Inderste/Inner
3	5032256 Højre/Right/Rechs Styrekugle/Tie rod end/Kugelgelenk -9/88 16x1,5 RHT Yderste/Outer/Außen
4	5032257 Venstre/Left/Links Styrekugle/Tie rod end/Kugelgelenk -9/88 16x1,5 LHT Yderste/Outer/Außen
5	5032266 V/H - L/R Styrekugle/Tie rod end/Kugelgelenk 10/88- Yderste/Outer/Außen
6	5032267 V/H - L/R Styrekugle/Tie rod end/Axialgelenk 10/88- Inderste/Inner
7	5042210 V/H - L/R Bærekugle/Ball joint/Radgelenk Øverste/Upper/Oben
8	5042225 V/H - L/R Bærekugle/Ball joint/Radgelenk Nederste/Lower/Unten
9	5112207 V/H - L/R Stabilisatorbolt/Stabilizer bolt/Stabilisator bolzen 210 mm.
POS Kubistar (X76) 8/03-	
Foraksel/Front axle/Vorneachse	
1	5013911 Venstre/Left/Links Bærearmlenke/Track control arm/Querlenker Nederste/Lower/Unten
2	5013912 Højre/Right/Rechs Bærearmlenke/Track control arm/Querlenker Nederste/Lower/Unten
3	5033937 V/H - L/R Styrekugle/Tie rod end/Axialgelenk 14x1,5 RHT Inderste/Inner
4	5033945 Venstre/Left/Links Styrekugle/Tie rod end/Kugelgelenk 14x1,5 RHT Yderste/Outer/Außen
5	5033946 Højre/Right/Rechs Styrekugle/Tie rod end/Kugelgelenk 14x1,5 RHT Yderste/Outer/Außen
6	5043919 V/H - L/R Bærekugle/Ball joint/Radgelenk 125 mm. Konus/Cone 16,0 mm.
7	5113902 V/H - L/R Stabilisator bolt/Stabilizer bolt/Stabilisator bolzen















POS	 Maxima J30 10/88-6/94
Foraksel/Front axle/Vorneachse	
1	<p>5032259 V/H - L/R -8/91 14x1,5 RHT  1</p> <p>Styrekugle/Tie rod end/Axialgelenk Inderste/Inner</p>
2	<p>5042229 V/H - L/R  2</p> <p>Bærekugle/Ball joint/Radgelenk Nederste/Lower/Unten</p>
3	<p>5112208 V/H - L/R 85 mm.  3</p> <p>Stabilisatorbolt/Stabilizer bolt/Stabilisator bolzen</p>
POS	 Maxima A32 QX 10/94-8/00
Foraksel/Front axle/Vorneachse	
1	<p>5112217 V/H - L/R 101 mm.  1</p> <p>Stabilisator/Stabilizer/Stabilisator</p>















POS	Micra K10 12/82-7/92			
Foraksel/Front axle/Vorneachse				
1	5032205 V/H - L/R Styrekugle/Tie rod end/Axialgelenk	2/85- 12x1,25/16x1 Inderste/Inner		1
2	5032244 V/H - L/R Styrekugle/Tie rod end/Kugelgelenk	12x1,25 Yderste/Outer/Außen		2
3	5032254 V/H - L/R Styrekugle/Tie rod end/Axialgelenk	-2/85 12x1,25/16x1 Inderste/Inner		3
4	5092203 (1.2) 3/89- Manchetsæt/Boot kit/Manschetten satz			4
5	5112201 V/H - L/R Stabilisatorbolt/Stabilizer bolt/Stabilisator bolzen	100 mm.		5
POS	Micra K11 8/92-2/03			
Foraksel/Front axle/Vorneachse				
1	5012203 Venstre/Left/Links Bærearmlenke/Track control arm/Querlenker			2
2	5012204 Højre/Right/Rechts Bærearmlenke/Track control arm/Querlenker			
3	5032261 V/H - L/R Styrekugle/Tie rod end/Kugelgelenk	12x1,25 RHT Yderste/Outer/Außen		3
4	5042231 V/H - L/R Bærekugle/Ball joint/Radgelenk	Nederste/Lower/Unten		4
5	5092207 Manchetsæt/Boot kit/Manschetten satz			
6	5102203 For/Front/Vorne Bøsning/Bushing/Buchsen			7
7	5102204 Bag/Rear/Hinten Bøsning/Bushing/Buchsen			
8	5112211 Stabilisatorbolt/Stabilizer bolt/Stabilisator bolzen	110 mm.		8

POS	Micra K11 8/92-2/03
Bagaksel/Rear axle/Hinterachse	
9	<p>5112212 V/H - L/R Stabilisator/Stabilizer/Stabilisator</p> <p>90 mm.</p> 
POS	Micra K12 1/03-
Foraksel/Front axle/Vorneachse	
1	<p>5012223 Venstre/Left/Links Bæream/Track control arm/Querlenker Nederste/Lower/Unten</p> 
2	<p>5012224 Højre/Right/Rechs Bæream/Track control arm/Querlenker Nederste/Lower/Unten</p> 
3	<p>5032269 Venstre/Left/Links Styrekugle/Tie rod end/Kugelgelenk Yderste/Outer/Außen</p> 
4	<p>5032270 Højre/Right/Rechs Styrekugle/Tie rod end/Kugelgelenk Yderste/Outer/Außen</p> 
5	<p>5042234 V/H - L/R Bærekugle/Ball joint/Radgelenk</p> 
6	<p>5112218 V/H - L/R Stabilisator/Stabilizer/Stabilisator</p> <p>247 mm.</p> 















POS	 Patrol 260 7/88-11/95
POS	 Patrol GR I Y60 & GR II Y61 4/92-
	<p>Foraksel/Front axle/Vorneachse</p> <p>1 5112213 161 mm. (Y60) Stabilisator/Stabilizer/Stabilisator</p>  <p>Bagaksel/Rear axle/Hinterachse</p> <p>2 5112213 161 mm. (Y60) Stabilisator/Stabilizer/Stabilisator</p> 



POS													
	<p>Prairie M10 8/82-1988</p> <p>Foraksel/Front axle/Vorneachse</p> <table border="0"> <tr> <td data-bbox="148 488 172 510">1</td> <td data-bbox="196 488 614 544"> 5032205 V/H - L/R Styrekugle/Tie rod end/Axialgelenk </td> <td data-bbox="655 488 815 544"> 12x1,25/16x1 Inderste/Inner </td> <td data-bbox="919 488 1098 533">  1 </td> </tr> <tr> <td data-bbox="148 577 172 600">2</td> <td data-bbox="196 577 614 633"> 5042203 V/H - L/R Bærekugle/Ball joint/Radgelenk </td> <td data-bbox="655 600 911 633"> Nederste/Lower/Unten </td> <td data-bbox="1070 555 1145 667">  2 </td> </tr> </table>	1	5032205 V/H - L/R Styrekugle/Tie rod end/Axialgelenk	12x1,25/16x1 Inderste/Inner	 1	2	5042203 V/H - L/R Bærekugle/Ball joint/Radgelenk	Nederste/Lower/Unten	 2				
1	5032205 V/H - L/R Styrekugle/Tie rod end/Axialgelenk	12x1,25/16x1 Inderste/Inner	 1										
2	5042203 V/H - L/R Bærekugle/Ball joint/Radgelenk	Nederste/Lower/Unten	 2										
	<p>Prairie M11 10/88-7/94</p> <p>Foraksel/Front axle/Vorneachse</p> <table border="0"> <tr> <td data-bbox="148 1361 172 1384">1</td> <td data-bbox="196 1361 614 1417"> 5032205 V/H - L/R Styrekugle/Tie rod end/Axialgelenk </td> <td data-bbox="655 1361 815 1417"> 12x1,25/16x1 Inderste/Inner </td> <td data-bbox="919 1350 1225 1417">  1 </td> </tr> <tr> <td data-bbox="148 1451 172 1473">2</td> <td data-bbox="196 1451 614 1507"> 5042229 V/H - L/R Bærekugle/Ball joint/Radgelenk </td> <td data-bbox="655 1473 911 1507"> Nederste/Lower/Unten </td> <td data-bbox="1026 1440 1177 1529">  2 </td> </tr> <tr> <td data-bbox="148 1541 172 1563">3</td> <td data-bbox="196 1541 614 1597"> 5112208 V/H - L/R Stabilisator/Stabilizer/Stabilisator </td> <td data-bbox="655 1541 743 1563"> 85 mm. </td> <td data-bbox="1209 1507 1369 1675">  3 </td> </tr> </table>	1	5032205 V/H - L/R Styrekugle/Tie rod end/Axialgelenk	12x1,25/16x1 Inderste/Inner	 1	2	5042229 V/H - L/R Bærekugle/Ball joint/Radgelenk	Nederste/Lower/Unten	 2	3	5112208 V/H - L/R Stabilisator/Stabilizer/Stabilisator	85 mm.	 3
1	5032205 V/H - L/R Styrekugle/Tie rod end/Axialgelenk	12x1,25/16x1 Inderste/Inner	 1										
2	5042229 V/H - L/R Bærekugle/Ball joint/Radgelenk	Nederste/Lower/Unten	 2										
3	5112208 V/H - L/R Stabilisator/Stabilizer/Stabilisator	85 mm.	 3										







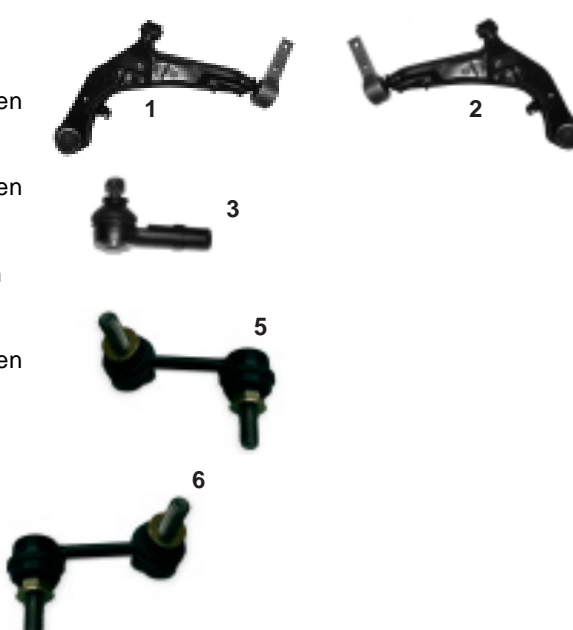
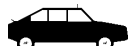

POS	Primastar 3/01-
Foraksel/Front axle/Vorneachse	
1	XXXXXXX Venstre/Left/Links Bærearml/Track control arm/Querlenker Nederste/Lower/Unten
2	XXXXXXX Højre/Right/Rechs Bærearml/Track control arm/Querlenker Nederste/Lower/Unten
3	5033662 V/H - L/R Styrekugle/Tie rod end/Axialgelenk Inderste/Inner 
4	5033663 Venstre/Left/Links Styrekugle/Tie rod end/Kugelgelenk 12x1,5 Yderste/Outer/Außen 
5	5033664 Højre/Right/Rechs Styrekugle/Tie rod end/Kugelgelenk 12x1,5 Yderste/Outer/Außen 
6	5043634 V/H - L/R Bærekugle/Ball joint/Radgelenk Nederste/Lower/Unten 
7	5113621 V/H - L/R Stabilisatorstang/Stabilizer rod/Diagonalstrebe 280 mm. 
POS	Primera P10 6/90-8/96
Foraksel/Front axle/Vorneachse	
1	5012205 Venstre/Left/Links Bærearml/Track control arm/Querlenker Nederste/Lower/Unten 
2	5012206 Højre/Right/Rechs Bærearml/Track control arm/Querlenker Nederste/Lower/Unten 
3	5012211 Venstre/Left/Links Bærearml/Track control arm/Querlenker Øverste/Upper/Oben 
4	5012212 Højre/Right/Rechs Bærearml/Track control arm/Querlenker Øverste/Upper/Oben 
5	5032258 V/H - L/R Styrekugle/Tie rod end/Kugelgelenk 12x1,25 RHT Konus/Cone 13 mm. Yderste/Outer/Außen 
6	5032259 V/H - L/R Styrekugle/Tie rod end/Axialgelenk 12x1,25 RHT Inderste/Inner 
7	5042228 V/H - L/R Bærekugle/Ball joint/Radgelenk Nederste/Lower/Unten 
8	5092204 -1/92 Manchetsæt/Boot kit/Manschetten satz 
9	5092205 1/92- Manchetsæt/Boot kit/Manschetten satz 









POS	Primera P10 6/90-8/96
Foraksel/Front axle/Vorneachse	
10	5102205 Bøsning/Bushing/Buchsen Øverste inderste/Upper Inner/Oben Innen  10
11	5102206 Bøsning/Bushing/Buchsen Øverste yderste/Upper outer/Oben außen  11
12	5102209 For/Front/Vorne Bøsning/Bushing/Buchsen V/H - L/R Nederste/Lower/Unten  12
13	5102210 Bag/Rear/Hinten Bøsning/Bushing/Buchsen V/H - L/R Nederste/Lower/Unten  13
14	5102211 V/H - L/R Rep. sæt t/bærearml/Repair kit for track control arm/ Reparatursatz für Querlenker  14
15	5112208 V/H - L/R (- 2.0) 85 mm. Stabilisatorbolt/Stabilizer bolt/Stabilisator bolzen  15
16	5112213 V/H - L/R (2.0) 161 mm. Stabilisator/Stabilizer/Stabilisator  16
Bagaksel/Rear axle/Hinterachse	
17	5112214 V/H - L/R 115 mm.  17
POS	Primera Wagon W10 7/90-3/98
Foraksel/Front axle/Vorneachse	
1	5032240 V/H - L/R 12x1,25 Styrekugle/Tie rod end/Kugelgelenk Yderste/Outer/Außen  1
2	5032260 V/H - L/R 12x1,25 RHT Styrekugle/Tie rod end/Axialgelenk Inderste/Inner  2
3	5042229 V/H - L/R Bærekugle/Ball joint/Radgelenk Nederste/Lower/Unten  3
4	5092204 -1/92 Manchetsæt/Boot kit/Manschetten satz
5	5092205 Manchetsæt/Boot kit/Manschetten satz  5
6	5102211 V/H - L/R Rep. sæt t/bærearml/Repair kit for track control arm/ Reparatursatz für Querlenker  4
7	5112208 V/H - L/R 85 mm. Stabilisatorbolt/Stabilizer bolt/Stabilisator bolzen  7
8	5112214 V/H - L/R 115 mm.  6
Foraksel/Front axle/Vorneachse	

POS	Primera P11 9/96-7/02		
1	5012211 Venstre/Left/Links Bærearml/Track control arm/Querlenker	Øverste/Upper/Oben	
2	5012212 Højre/Right/Rechs Bærearml/Track control arm/Querlenker	Øverste/Upper/Oben	
3	5012213 Venstre/Left/Links Bærearml/Track control arm/Querlenker	Nederste/Lower/Unten	
4	5012214 Højre/Right/Rechs Bærearml/Track control arm/Querlenker	Nederste/Lower/Unten	
5	5032258 V/H - L/R 12x1,25 RHT Styrekugle/Tie rod end/Kugelgelenk	Konus/Cone 13 mm. Yderste/Outer/Außen	
6	5042228 V/H - L/R Bærekugle/Ball joint/Radgelenk	Nederste/Lower/Unten	
7	5092205 Manchetsæt/Boot kit/Manschetten satz		
8	5102205 V/H - L/R Bøsning/Bushing/Buchsen	Øverste inderste/Upper inner/Oben Innen	
9	5102206 V/H - L/R Bøsning/Bushing/Buchsen	Øverste yderst/Upper outer/Oben Außen	
10	5102207 For/Front/Vorne Bøsning/Bushing/Buchsen	Venstre/Left/Links Nederste/Lower/Unten	
11	5102208 For/Front/Vorne Bøsning/Bushing/Buchsen	Højre/Right/Rechs Nederste/Lower/Unten	
POS			
12	5102211 V/H - L/R Rep. Sæt t/bærearml/Repair kit for track control arm/ Reparatursatz für Querlenker		
13	5112209 V/H - L/R Stabilisator/Stabilizer/Stabilisator	171 mm.	

POS	 Primera Wagon W11 1/98-				
Foraksel/Front axle/Vorneachse					
1	5012211 Venstre/Left/Links Bærearml/Track control arm/Querlenker	Øverste/Upper/Oben			
2	5012212 Højre/Right/Rechs Bærearml/Track control arm/Querlenker	Øverste/Upper/Oben			
3	5012213 Venstre/Left/Links Bærearml/Track control arm/Querlenker	Nederste/Lower/Unten			
4	5012214 Højre/Right/Rechs Bærearml/Track control arm/Querlenker	Nederste/Lower/Unten			
5	5032258 V/H - L/R 12x1,25 RHT Styrekugle/Tie rod end/Kugelgelenk	Konus/Cone 13 mm. Yderste/Outer/Außen			
6	5042228 V/H - L/R Bærekugle/Ball joint/Radgelenk	Nederste/Lower/Unten			
7	5092205 Manchetsæt/Boot kit/Manschetten satz				
8	5102205 V/H - L/R Bøsning/Bushing/Buchsen				
9	5102206 V/H - L/R Bøsning/Bushing/Buchsen				
10	5102207 For/Front/Vorne Bøsning/Bushing/Buchsen	Venstre/Left/Links			
POS					
11	5102208 For/Front/Vorne Bøsning/Bushing/Buchsen	Højre/Right/Rechs			
12	5102211 V/H - L/R Rep. Sæt t/bærearml/Repair kit for track control arm/ Reparatursatz für Querlenker				
13	5112209 V/H - L/R Stabilisator/Stabilizer/Stabilisator	171 mm.	13		











POS	 Primera P12 3/02-
Foraksel/Front axle/Vorneachse	
1	5012221 Venstre/Left/Links Bærearml/Track control arm/Querlenker Nederste/Lower/Unten
2	5012222 Højre/Right/Rechs Bærearml/Track control arm/Querlenker Nederste/Lower/Unten
3	5032258 V/H - L/R Styrekugle/Tie rod end/Kugelgelenk Yderste/Outer/Außen
4	5042235 V/H - L/R Bærekugle/Ball joint/Radgelenk Nederste/Lower/Unten
5	5112223 Venstre/Left/Links 65 mm. Stabilisator/Stabilizer/Stabilisator
6	5112224 Højre/Right/Rechs 65 mm. Stabilisator/Stabilizer/Stabilisator
Bagaksel/Rear axle/Hinterachse	
7	5112222 V/H - L/R 91 mm. Stabilisator/Stabilizer/Stabilisator
	
POS	 Primera Wagon W12 3/02-
Foraksel/Front axle/Vorneachse	
1	5012221 Venstre/Left/Links Bærearml/Track control arm/Querlenker Nederste/Lower/Unten
2	5012222 Højre/Right/Rechs Bærearml/Track control arm/Querlenker Nederste/Lower/Unten
3	5032258 V/H - L/R Styrekugle/Tie rod end/Kugelgelenk Yderste/Outer/Außen
4	5042235 V/H - L/R Bærekugle/Ball joint/Radgelenk Nederste/Lower/Unten
5	5112223 Venstre/Left/Links 65 mm. Stabilisator/Stabilizer/Stabilisator
6	5112224 Højre/Right/Rechs 65 mm. Stabilisator/Stabilizer/Stabilisator
Bagaksel/Rear axle/Hinterachse	
7	5112222 V/H - L/R 91 mm. Stabilisator/Stabilizer/Stabilisator
	

POS	 Serena C23M 11/92-
Foraksel/Front axle/Vorneachse	
1	5032258 V/H - L/R 12x1,25 RHT Styrekugle/Tie rod end/Kugelgelenk Konus/Cone 13 mm. Yderste/Outer/Außen  1
2	5042232 Venstre/Left/Links Bærekugle/Ball joint/Radgelenk 9/93- Nederste/Lower/Unten  2
3	5042233 Højre/Right/Rechs Bærekugle/Ball joint/Radgelenk 9/93- Nederste/Lower/Unten  3
4	5092208 Manchetsæt/Boot kit/Manschetten satz  4
5	5112215 Venstre/Left/Links Stabilisator/Stabilizer/Stabilisator 120 mm.  5
6	5112216 Højre/Right/Rechs Stabilisator/Stabilizer/Stabilisator 120 mm.  6
POS	 Silvia S12 4/84-9/88
Foraksel/Front axle/Vorneachse	
1	5032205 V/H - L/R Styrekugle/Tie rod end/Axialgelenk 12x1,25/16x1 Inderste/Inner  1









POS	 Stanza T11 8/81-12/85
Foraksel/Front axle/Vorneachse	
1	<p>5032204 V/H - L/R 12x1,25  1</p> <p>Styrekugle/Tie rod end/Kugelgelenk Yderste/Outer/Außen</p>
2	<p>5032205 V/H - L/R 12x1,25/16x1  2</p> <p>Styrekugle/Tie rod end/Axialgelenk Inderste/Inner</p>
3	<p>5112201 U V/H - L/R 100 mm.  3</p> <p>Stabilisatorbolt/Stabilizer bolt/Stabilisator bolzen</p>
POS	 Sunny I B11 3/82-9/87
Foraksel/Front axle/Vorneachse	
1	<p>5032204 V/H - L/R 12x1,25  1</p> <p>Styrekugle/Tie rod end/Kugelgelenk Yderste/Outer/Außen</p>
2	<p>5032205 V/H - L/R 12x1,25/16x1  2</p> <p>Styrekugle/Tie rod end/Axialgelenk Inderste/Inner</p>
3	<p>5042203 V/H - L/R  3</p> <p>Bærekugle/Ball joint/Radgelenk Nederste/Lower/Unten</p>
4	<p>5112201 U V/H - L/R 100 mm.  4</p> <p>Stabilisatorbolt/Stabilizer bolt/Stabilisator bolzen</p>



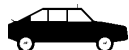









POS	Sunny II B12 6/86-6/91
Foraksel/Front axle/Vorneachse	
1	5012215 U Venstre/Left/Links Bæream med bærekugle/ Nederste/Lower/Unten Track control arm with ball joint/Querlenker mit Radgelenk
2	5012216 U Højre/Right/Rechs Bæream med bærekugle/ Nederste/Lower/Unten Track control arm with ball joint/Querlenker mit Radgelenk
3	5032205 V/H - L/R 12x1,25/16x1 Styrekugle/Tie rod end/Axialgelenk Inderste/Inner
4	5032242 V/H - L/R 12x1,25 Styrekugle/Tie rod end/Kugelgelenk Yderste/Outer/Außen
5	5042228 V/H - L/R Bærekugle/Ball joint/Radgelenk Nederste/Lower/Unten
6	5092203 Manchetsæt/Boot kit/Manschetten satz
7	5112208 V/H - L/R 85 mm. Stabilisatorbolt/Stabilizer bolt/Stabilisator bolzen
POS	Sunny II N13 6/86-8/91
Foraksel/Front axle/Vorneachse	
1	5012215 U Venstre/Left/Links Bæream med bærekugle/ Nederste/Lower/Unten Track control arm with ball joint/Querlenker mit Radgelenk
2	5012216 U Højre/Right/Rechs Bæream med bærekugle/ Nederste/Lower/Unten Track control arm with ball joint/Querlenker mit Radgelenk
3	5032242 V/H - L/R 12x1,25 Styrekugle/Tie rod end/Kugelgelenk Yderste/Outer/Außen
4	5032253 V/H - L/R 12x1,25/14x1,5 Styrekugle/Tie rod end/Axialgelenk Inderste/Inner
5	5042228 V/H - L/R Bærekugle/Ball joint/Radgelenk Nederste/Lower/Unten
6	5092203 Manchetsæt/Boot kit/Manschetten satz
7	5112208 V/H - L/R Stabilisatorbolt/Stabilizer bolt/Stabilisator bolzen



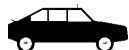



POS	Sunny III N14 10/90-5/95			
Foraksel/Front axle/Vorneachse				
1	5012209 Venstre/Left/Links Bærearml/Track control arm/Querlenker	(-2.0 GTi) Nederste/Lower/Unten		
2	5012210 Højre/Right/Rechs Bærearml/Track control arm/Querlenker	(-2.0 GTi) Nederste/Lower/Unten		
3	5032240 V/H - L/R (-2.0 GTi) Styrekugle/Tie rod end/Kugelgelenk	12x1,25 Yderste/Outer/Außen		
4	5042230 V/H - L/R (-2.0 GTi) Bærekugle/Ball joint/Radgelenk	Nederste/Lower/Unten		
5	5112208 V/H - L/R 85 mm. Stabilisatorbolt/Stabilizer bolt/Stabilisator bolzen			
6	5112209 V/H - L/R 171 mm. Stabilisator/Stabilizer/Stabilisator			
POS	Sunny III Y10 6/91-			
Foraksel/Front axle/Vorneachse				
1	5012209 Venstre/Left/Links Bærearml/Track control arm/Querlenker	Nederste/Lower/Unten		
2	5012210 Højre/Right/Rechs Bærearml/Track control arm/Querlenker	Nederst/Lower/Unten		
3	5042230 V/H - L/R Bærekugle/Ball joint/Radgelenk	Nederste/Lower/Unten		
4	5112208 V/H - L/R 85 mm. Stabilisatorbolt/Stabilizer bolt/Stabilisator bolzen			
Bagaksel/Rear axle/Hinterachse				
5	5032240 V/H - L/R Styrekugle/Tie rod end/Kugelgelenk	12x1,25 Yderste/Outer/Außen		









POS	 Terrano I VD21/WD21 8/86-12/95	
Foraksel/Front axle/Vorneachse		
1	5032247 V/H - L/R Styrekugle/Tie rod end/Kugelgelenk 16x1,5 Yderste/Outer/Außen	 1
2	5032248 V/H - L/R Styrekugle/Tie rod end/Axialgelenk 16x1,5 Inderste styrekugle	 2
3	5042210 V/H - L/R Bærekugle/Ball joint/Radgelenk Øverste/Upper/Oben	 3
4	5042220 V/H - L/R Bærekugle/Ball joint/Radgelenk Nederste/Lower/Unten	 4
POS	 Terrano II R20 2/93-	
Foraksel/Front axle/Vorneachse		
1	5032247 V/H - L/R Styrekugle/Tie rod end/Kugelgelenk 16x1,5 Yderste/Outer/Außen	 1
2	5032248 V/H - L/R Styrekugle/Tie rod end/Axialgelenk 16x1,5 Inderste/Inner	 2
3	5042210 V/H - L/R Bærekugle/Ball joint/Radgelenk Øverste/Upper/Oben	 3
4	5042220 V/H - L/R Bærekugle/Ball joint/Radgelenk Nederste/Lower/Unten	 4
5	5112205 V/H - L/R 140 mm. Stabilisatorbolt/Stabilizer bolt/Stabilisator bolzen	 5





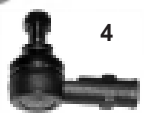



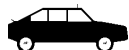

POS	Urvan E23 8/80-11/88			
Foraksel/Front axle/Vorneachse				
1	5042210 V/H - L/R Bærekugle/Ball joint/Radgelenk	Øverste/Upper/Oben		
2	5042216 U Venstre/Left/Links Bærekugle/Ball joint/Radgelenk	Nederste/Lower/Unten		
POS	Urvan E24 9/86-			
Foraksel/Front axle/Vorneachse				
1	5032256 Venstre/Left/Links Styrekugle/Tie rod end/Axialgelenk	-9/88 Inderste/Inner		
2	5032256 Højre/Right/Rechs Styrekugle/Tie rod end/Kugelgelenk	-9/88 Yderste/Outer/Außen		
3	5032257 Højre/Right/Rechs Styrekugle/Tie rod end/Axialgelenk	-9/88 Inderste/Inner		
4	5032257 Venstre/Left/Links Styrekugle/Tie rod end/Kugelgelenk	-9/88 Yderste/Outer/Außen		
5	5032266 V/H - L/R Styrekugle/Tie rod end/Kugelgelenk	10/88- Yderste/Outer/Außen		
6	5032267 V/H - L/R Styrekugle/Tie rod end/Axialgelenkgelenk	10/88- Inderste/Inner		
7	5042210 V/H - L/R Bærekugle/Ball joint/Radgelenk	Øverste/Upper/Oben		
8	5042225 V/H - L/R Bærekugle/Ball joint/Radgelenk	Nederste/Lower/Unten		
9	5112207 V/H - L/R Stabilisatorbolt/Stabilizer bolt/Stabilisator bolzen			

POS	 Vanette C120 6/81-12/87
Foraksel/Front axle/Vorneachse	
1	5042227 V/H - L/R Bærekugle/Ball joint/Radgelenk Øverste/Upper/Oben  1
2	5032225 U Venstre/Left/Links Styrekugle/Tie rod end/Kugelgelenk Yderste/Outer/Außen  2
POS	 Vanette C22 2WD 5/86-12/95
Foraksel/Front axle/Vorneachse	
1	5032249 Venstre/Left/Links 14x1,5 RHT Styrekugle/Tie rod end/Kugelgelenk Yderste/Outer/Außen  1
2	5032250 Højre/Right/Rechs 14x1,5 LHT Styrekugle/Tie rod end/Kugelgelenk Yderste/Outer/Außen  2
3	5032251 Venstre/Left/Links 14x1,5 LHT Konus/Cone 13,5 mm. Styrekugle/Tie rod end/Axialgelenk Inderste/Inner  3
4	5032252 Højre/Right/Rechs 14x1,5 LHT Konus/Cone 13,5 mm. Styrekugle/Tie rod end/Axialgelenk Inderste/Inner  4
5	5042226 V/H - L/R Bærekugle/Ball joint/Radgelenk Nederste/Lower/Unten  5
6	5042227 V/H - L/R Bærekugle/Ball joint/Radgelenk Øverste/Upper/Oben  6











POS	 Vanette C22 4WD 11/86-12/95
Foraksel/Front axle/Vorneachse	
1	5032249 Venstre/Left/Links 14x1,5 RHT  1 Styrekugle/Tie rod end/Kugelgelenk Yderste/Outer/Außen
2	5032250 Højre/Right/Rechs 14x1,5 LHT  2 Styrekugle/Tie rod end/Kugelgelenk Yderste/Outer/Außen
3	5032251 Venstre/Left/Links 14x1,5 LHT Konus/Cone 13,5 mm.  3 Styrekugle/Tie rod end/Axialgelenk Inderste/Inner
4	5032252 Højre/Right/Rechs 14x1,5 RHT Konus/Cone 13,5 mm.  4 Styrekugle/Tie rod end/Axialgelenk Inderste/Inner
5	5042210 V/H - L/R  5 Bærekugle/Ball joint/Radgelenk Nederste/Lower/Unten
POS	 Vanette HC23 1/95-
Foraksel/Front axle/Vorneachse	
1	5032258 V/H - L/R 12x1,25 RHT Konus/Cone 13 mm.  1 Styrekugle/Tie rod end/Kugelgelenk Yderste/Outer/Außen
2	5032265 V/H - L/R  2 Styrekugle/Tie rod end/Axialgelenk Inderste/Inner
3	5042232 Venstre/Left/Links  3 Bærekugle/Ball joint/Radgelenk Nederste/Lower/Unten
4	5042233 Højre/Right/Rechs  4 Bærekugle/Ball joint/Radgelenk Nederste/Lower/Unten
5	5112215 Venstre/Left/Links 120 mm.  5 Stabilisator/Stabilizer/Stabilisator
6	5112216 Højre/Right/Rechs 120 mm.  6 Stabilisator/Stabilizer/Stabilisator









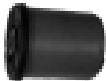





POS	 X-TRAIL T30 7/01-
Foraksel/Front axle/Vorneachse	
1	5032271 V/H - L/R 14x1,5 RHT Styrekugle/Tie rod end/Kugelgelenk Yderste/Outer/Außen  1
2	5112219 Venstre/Left/Links 68 mm. Stabilisator/Stabilizer/Stabilisator  2
3	5112220 Højre/Right/Rechs 68 mm. Stabilisator/Stabilizer/Stabilisator  3
Bagaksel/Rear axle/Hinterachse	
4	5112221 V/H - L/R 117 mm. Stabilisator/Stabilizer/Stabilisator  4
POS	

















POS	 Agila H00 9/00-
Foraksel/Front axle/Vorneachse	
1	<p>5013619 V/H - L/R Ch. -1G075421 Bærearml/Track control arm/Querlenker Nederste/Lower/Unten</p>  1
2	<p>5013620 V/H - L/R Ch. 1G075422- Bærearml/Track control arm/Querlenker Nederste/Lower/Unten</p>  2
3	<p>5033657 V/H - L/R Ch. -1G075421 Styrekugle/Tie rod end/Kugelgelenk 12x1,25 RHT Yderste/Outer/Außen</p>  3
4	<p>5033658 V/H - L/R Ch. 1G075422- Styrekugle/Tie rod end/Kugelgelenk Yderste/Outer/Außen</p>  4
5	<p>5033659 V/H - L/R 12x1,25 RHT Styrekugle/Tie rod end/Axialgelenk Inderste/Inner</p>  5
6	<p>5103613 For/Front/Vorne V/H - L/R Bøsning/Bushing/Buchsen</p>  6
7	<p>5103614 Bag/Rear/Hinten V/H - L/R Bøsning/Bushing/Buchsen</p>  7
POS	 Arena 3/98-8/01

POS	 Ascona A 10/70-8/75
Foraksel/Front axle/Vorneachse	
1	<p>5033610 U V/H - L/R 14x1,5 RHT Styrekugle/Tie rod end/Kugelgelenk</p> <p>Konus/Cone 14,0 mm. Yderste/Outer/Außen</p>  1
2	<p>5043608 U V/H - L/R Bærekugle/Ball joint/Radgelenk</p> <p>Nederste/Lower/Unten</p>  2
3	<p>5093603 U Manchetsæt/Boot kit/Manschetten satz</p>  3
POS	 Ascona B 9/75-8/81
Foraksel/Front axle/Vorneachse	
1	<p>5023607 U Tandstang/Steering rack/Zahnstange</p>  1
2	<p>5033603 V/H - L/R 14x1,25 Styrekugle/Tie rod end/Kugelgelenk</p> <p>Yderste/Outer/Außen</p>  2
3	<p>5043610 V/H - L/R Bærekugle/Ball joint/Radgelenk</p> <p>Øverste/Upper/Oben</p>  3
4	<p>5043611 V/H - L/R Bærekugle/Ball joint/Radgelenk</p> <p>Nederste/Lower/Unten</p>  4
5	<p>5093602 Manchetsæt/Boot kit/Manschetten satz</p>  5
6	<p>5113602 V/H - L/R 170 mm. Stabilisatorbolt/Stabilizer bolt/Stabilisator bolzen</p>  6









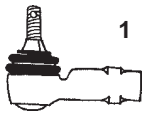
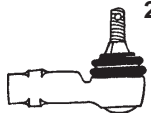

POS	Ascona C 9/81-10/88				
Foraksel/Front axle/Vorneachse					
1	5003626 Venstre/Left/Links Styrekugle/Tie rod end/Axialgelenk	Inderste/Inner		1	
2	5003629 Højre/Right/Rechs Styrestang/Steering rod/Spurstange			2	
3	5033611 Venstre/Left/Links Styrekugle/Tie rod end/Kugelgelenk	16x1,5 RHT Yderste/Outer/Außen		3	
4	5033612 Højre/Right/Rechs Styrekugle/Tie rod end/Kugelgelenk	16x1,5 RHT Yderste/Outer/Außen		4	
5	5033622 V/H - L/R 16x1,5 Mellemlid/Intermediate link/Zwischengleid			5	
6	5043612 V/H - L/R Bærekugle/Ball joint/Radgelenk	Nederste/Lower/Unten		6	
7	5093605 Manchetsæt/Boot kit/Manschetten satz			7	
8	5113601 V/H - L/R 160 mm. Stabilisatorbolt/Stabilizer bolt/Stabilisator bolzen			8	
Bagaksel/Rear axle/Hinterachse					
9	5103604 V/H - L/R Ch. J1189307- (O.E.402645) Bøsning/Bushing/Buchsen			9	
POS Astra F 8/91-3/01					
Foraksel/Front axle/Vorneachse					
1	5003619 Venstre/Left/Links Styrestang/Steering rod/Spurstange			1	
2	5003620 Højre/Right/Rechs Styrestang/Steering rod/Spurstange			2	
3	5013607 Venstre/Left/Links Bærearmlenke/Track control arm/Querlenker			3	
4	5013608 Højre/Right/Rechs Bærearmlenke/Track control arm/Querlenker			4	
5	5033637 Venstre/Left/Links Styrekugle/Tie rod end/Kugelgelenk	16x2 RHT Yderste/Outer/Außen		5	
6	5033638 Højre/Right/Rechs Styrekugle/Tie rod end/Kugelgelenk	Yderste/Outer/Außen		6	
7	5033639 16x2,0 Mellemlid/Intermediate link/Zwischenglied			7	
8	5043612 V/H - L/R Bærekugle/Ball joint/Radgelenk	Nederste/Lower/Unten		8	
9	5093605 (*) Manchetsæt/Boot kit/Manschetten satz			9	
10	5093609 ZF (**) Manchetsæt/Boot kit/Manschetten satz			10	
					(*) Uden servostyring Without Power Steering Ohne Servolenkung
					(**) Med servostyring With Power Steering Mit Servolenkung









POS	 Astra F 8/91-3/01				
Foraksel/Front axle/Vorneachse					
11	5093614 Saginaw Manchetsæt/Boot kit/Manschetten satz				11
12	5103601 For/Front/Vorne Indvendig/Inner/Innen 16 mm. Bøsning/Bushing/Buchsen	V/H - L/R (O.E.352 346)			12
13	5103602 Bag/Rear/Hinten Ch. -R2587416/-R5111734/-R8145949 Indvendig/Inner/Innen 16 mm. Bøsning/Bushing/Buchsen	V/H - L/R -7/93 (O.E.352 348)			13
14	5103603 Bag/Rear/Hinten Ch. R2587417/-R5111735/-R8145950- Indvendig/Inner/Innen 16 mm. Bøsning/Bushing/Buchsen	V/H - L/R 7/93- (O.E.352 356)			14
15	5103699 Bag/Rear/Hinten Bøsning/Bushing/Buchsen	V/H - L/R			15
16	5113605 V/H - L/R -1/94 Ø22 mm. Ch. -R2588487/-R5111734/-R8145949 Stabilisator/Stabilizer/Stabilisator	83 mm. (O.E.350 260)			16
17	5113606 V/H - L/R 1/94- Ø18 mm. Ch. -R2595225/-R5111734/-R8145949 Stabilisator/Stabilizer/Stabilisator	83 mm. (O.E.350 261)			17
18	5113608 V/H - L/R 1/94- 85 mm. Ch. R2595226/-R5111735/-R8145950- Stabilisatorbolt/Stabilizer bolt/Stabilisator bolzen	(O.E.350 263)			18
POS					
Bagaksel/Rear axle/Hinterachse					
19	5103604 V/H - L/R (- Cabrio & GSi) Bøsning/Bushing/Buchsen	(O.E.402 645)			19







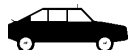

POS	 Astra F Classic 1/98-			
Foraksel/Front axle/Vorneachse				
1	5003619 Venstre/Left/Links Styrestang/Steering rod/Spurstange		1	
2	5003620 Højre/Right/Rechs Styrestang/Steering rod/Spurstange		2	
3	5013607 Venstre/Left/Links Bæream/Track control arm/Querlenker		3	
4	5013608 Højre/Right/Rechs Bæream/Track control arm/Querlenker		4	
5	5033637 Venstre/Left/Links Styrekugle/Tie rod end/Kugelgelenk	16x2 RHT Yderste/Outer/Außen		5
6	5033638 Højre/Right/Rechs Styrekugle/Tie rod end/Kugelgelenk	Yderste/Outer/Außen		
7	5033639 16x2 Justerbolt/Intermediate link/Zwischenglied		7	
8	5043612 V/H - L/R Bærekugle/Ball joint/Radgelenk	Nederste/Lower/Unten		8
9	5103601 For/Front/Vorne V/H - L/R Bøsning/Bushing/Buchsen	Indvendig/Inner/Innen 12 mm.		9
10	5103603 Bag/Rear/Hinten V/H - L/R Bøsning/Bushing/Buchsen	Indvendig/Inner/Innen 16 mm.		10
POS				
11	5103699 V/H - L/R Bøsning/Bushing/Buchsen		11	
12	5113608 V/H - L/R 85 mm. Ch. R2595226-/R5111735-/R8145950- Stabilisatorbolt/Stabilizer bolt/Stabilisator bolzen	(O.E.350 263)		12
Bagaksel/Rear axle/Hinterachse				
13	5103604 V/H - L/R Bøsning/Bushing/Buchsen		13	

POS	Astra G 2/98-
Foraksel/Front axle/Vorneachse	
1	5013615 Venstre/Left/Links Bærearml/Track control arm/Querlenker  1
2	5013616 Højre/Right/Rechs Bærearml/Track control arm/Querlenker  2
3	5033655 V/H - L/R 14x1,5 RHT Styrekugle/Tie rod end/Kugelgelenk Yderste/Outer/Außen  3
4	5033660 V/H - L/R (ZF) Styrekugle/Tie rod end/Axialgelenk Inderste/Inner  4
5	5043627 V/H - L/R Bærekugle/Ball joint/Radgelenk Nederste/Lower/Unten  5
6	5093613 Manchetsæt/Boot kit/Manschetten satz
7	5103611 For/Front/Vorne Bøsning/Bushing/Buchsen V/H - L/R  7
8	5103612 Bag/Rear/Hinten Bøsning/Bushing/Buchsen V/H - L/R  8
9	5113611 V/H - L/R 300 mm. Stabilisatorstang/Stabilizer rod/Diagonalstrebe  9
POS	Astra H 3/04-
Foraksel/Front axle/Vorneachse	
1	5013631 Venstre/Left/Links Bærearml/Track control arm/Querlenker  1
2	5013632 Højre/Right/Rechs Bærearml/Track control arm/Querlenker  2
3	5033660 V/H - L/R (ZF) Styrekugle/Tie rod end/Axialgelenk Inderste/Inner  3
4	5033671 Venstre/Left/Links Styrekugle/Tie rod end/Kugelgelenk Yderste/Outer/Außen  4
5	5033672 Højre/Right/Rechs Styrekugle/Tie rod end/Kugelgelenk Yderste/Outer/Außen  5
6	5043627 V/H - L/R Bærekugle/Ball joint/Radgelenk Nederste/Lower/Unten  6
7	5113611 V/H - L/R (- Interactive Driving System) Stabilisatorstang/Stabilizer rod/Diagonalstrebe  7
8	5113612 V/H - L/R (Interactive Driving System) Stabilisatorstang/Stabilizer rod/Diagonalstrebe  8

POS	Calibra 9/89-7/97				
Foraksel/Front axle/Vorneachse					
1	5003619 Venstre/Left/Links Styrestang/Steering rod/Spurstange		1		
2	5003620 Højre/Right/Rechs Styrestang/Steering rod/Spurstange		2		
3	5013607 Venstre/Left/Links Bærearmlenke/Track control arm/Querlenke		3		
4	5013608 Højre/Right/Rechs Bærearmlenke/Track control arm/Querlenke		4		
5	5033637 Venstre/Left/Links Styrekugle/Tie rod end/Kugelgelenk	16x2 RHT Yderste/Outer/Außen			5
6	5033638 Højre/Right/Rechs Styrekugle/Tie rod end/Kugelgelenk	16x2 RHT Yderste/Outer/Außen			6
7	5033639 16x2 Justerbolt/Intermediate link/Zwischenglied				7
8	5043612 V/H - L/R Bærekugle/Ball joint/Radgelenk	Nederste/Lower/Unten			8
9	5093609 ZF (**) Manchetsæt/Boot kit/Manschetten satz		9		
10	5103601 For/Front/Vorne V/H - L/R Indvendig/Inner/Innen 12 mm. Bøsning/Bushing/Buchsen	(O.E.352 346)			10
(**) Med servostyring With Power Steering Mit Servolenkung					
POS					
11	5103602 Bag/Rear/Hinten V/H - L/R -7/93 Ch. -R9003126 (O.E.352 348) Indvendig/Inner/Innen 16 mm. Bøsning/Bushing/Buchsen				11
12	5103603 Bag/Rear/Hinten V/H - L/R 7/93- Ch. R9003127- (O.E.352 356) Indvendig/Inner/Innen 16 mm. Bøsning/Bushing/Buchsen				12
13	5103699 Bag/Rear/Hinten V/H - L/R Bøsning/Bushing/Buchsen				13
14	5113605 V/H - L/R -1/94 Ch. -R1049313/-R9003174 Ø 22 mm. 83 mm. Stabilisator/Stabilizer/Stabilisator				14
15	5113608 V/H - L/R 1/94- Ch. R1049314/-R9003175- Stabilisatorbolt/Stabilizer bolt/Stabilisator bolzen (O.E.350 263)				15















POS	 Campo 8/91-			
Foraksel/Front axle/Vorneachse				
1	5031410 V/H - L/R 14x1,5 LHT Styrekugle/Tie rod end/Axialgelenk	Konus/Cone 16,0 mm. Inderste/Inner		1
2	5031411 V/H - L/R 14x1,5 RHT Styrekugle/Tie rod end/Kugelgelenk	Konus/Cone 16,0 mm. Yderste/Outer/Außen		2
4	5043630 V/H - L/R Bærekugle/Ball joint/Radgelenk	Øverste/Upper/Oben		4
5	5043631 V/H - L/R 4WD Bærekugle/Ball joint/Radgelenk	Nederste/Lower/Unten		5
POS	 Combo (Corsa) 7/94-10/01			
Foraksel/Front axle/Vorneachse				
1	5013613 Venstre/Left/Links -5/97 Ch. -V3023597/-V4166925/-V6066279 Bærearmlenke/Track control arm/Querlenker	Nederste/Lower/Unten		1
2	5013614 Højre/Right/Rechs -5/97 Ch. -V3023597/-V4166925/-V6066279 Bærearmlenke/Track control arm/Querlenker	Nederste/Lower/Unten		2
3	5013621 Venstre/Left/Links 5/97- Ch. V3023598/-V4166926/-V6066280- Bærearmlenke/Track control arm/Querlenker	Nederste/Lower/Unten		3
4	5013622 Højre/Right/Rechs 5/97- Ch. V3023598/-V4166926/-V6066280- Bærearmlenke/Track control arm/Querlenker	Nederste/Lower/Unten		4
5	5033623 V/H - L/R -5/97 12x1,5 RHT Ch. -V3023597/-V4166925/-V6066279 Styrekugle/Tie rod end/Kugelgelenk	Yderste/Outer/Außen		5
6	5033656 V/H - L/R 5/97- 12x1,5 Ch. V3023598/-V4166926/-V6066280- Styrekugle/Tie rod end/Kugelgelenk	Yderste/Outer/Außen		6
7	5033644 V/H - L/R 12x1,5 RHT Styrekugle/Tie rod end/Axialgelenk	(*) Inderste/Inner		7
			(*) Uden servostyring Without Power Steering Ohne Servolenkung	

POS	 Combo (Corsa) 7/94-10/01
Foraksel/Front axle/Vorneachse	
8	5033645 V/H - L/R 12x1,5 RHT (**) Styrekugle/Tie rod end/Axialgelenk Inderste/Inner  8
9	5043622 V/H - L/R -5/97 Bærekugle/Ball joint/Radgelenk Nederste/Lower/Unten  9
10	5043629 V/H - L/R 5/97- Bærekugle/Ball joint/Radgelenk Nederste/Lower/Unten  10
11	5093608 (**) Manchetsæt/Boot kit/Manschetten satz  11
12	5103605 V/H - L/R Bøsning/Bushing/Buchsen  12
(**) Med servostyring With Power Steering Mit Servolenkung	
POS	 Combo 10/01-
Foraksel/Front axle/Vorneachse	
1	5113609 V/H - L/R 244 mm. Stabilisatorstang/Stabilizer rod/Diagonalstrebe  1

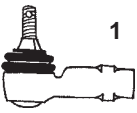
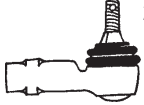











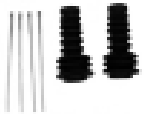

POS	 Commodore A 8/66-12/71
Foraksel/Front axle/Vorneachse	
1	5033613 V/H - L/R 14x1,5 RHT Styrekugle/Tie rod end/Axialgelenk Inderste/Inner  1
2	5033614 V/H - L/R 14x1,5 LHT Styrekugle/Tie rod end/Kugelgelenk Yderste/Outer/Außen  2
POS	 Commodore B 1/72-7/78
Foraksel/Front axle/Vorneachse	
1	5033615 U V/H - L/R 14x1,5 RHT Styrekugle/Tie rod end/Axialgelenk Konus/Cone 14,0 mm. Inderste/Inner  1
2	5033616 U V/H - L/R 14x1,5 LHT Styrekugle/Tie rod end/Kugelgelenk Konus/Cone 14,0 mm. Yderste/Outer/Außen  2
3	5033617 V/H - L/R Mellemlid/Intermediate link/Zwischenglied  3
4	5113604 V/H - L/R 140 mm. Stabilisatorbolt/Stabilizer bolt/Stabilisator bolzen  4









POS	Commodore C 8/78-12/82			
Foraksel/Front axle/Vorneachse				
1	5003614 U Midt/Center/Mitte Styrestang/Steering rod/Spurstange			1
2	5003615 U Midt/Center/Mitte (Diesel) Styrestang/Steering rod/Spurstange			2
3	5033617 V/H - L/R Mellemlid/Intermediate link/Zwischenglied			3
4	5033618 V/H - L/R 14x1,5 Styrekugle/Tie rod end/Kugelgelenk	Yderste/Outer/Außen		4
5	5033619 V/H - L/R 14x1,5 Styrekugle/Tie rod end/Axialgelenk	Inderste/Inner		5
6	5043620 V/H - L/R Bærekugle/Ball joint/Radgelenk	Nederste/Lower/Unten		6
7	5113604 V/H - L/R 140 mm. Stabilisatorbolt/Stabilizer bolt/Stabilisator bolzen			7
8	5113607 V/H - L/R 195 mm. Stabilisatorstang/Stabilizer rod/Diagonalstrebe			8
POS	Corsa A 9/82-3/93			
Foraksel/Front axle/Vorneachse				
1	5013609 Venstre/Left/Links Bærearmlenke/Track control arm/Querlenker	Nederste/Lower/Unten		1
2	5013610 Højre/Right/Rechts Bærearmlenke/Track control arm/Querlenker	Nederste/Lower/Unten		2
4	5033623 V/H - L/R 12x1,5 RHT Styrekugle/Tie rod end/Kugelgelenk	Yderste/Outer/Außen		4
5	5033628 V/H - L/R 14x1,5 RHT Styrekugle/Tie rod end/Axialgelenk	Inderste/Inner		6
6	5043622 V/H - L/R Bærekugle/Ball joint/Radgelenk	Nederste/Lower/Unten		6

















POS	Corsa B 3/93-9/00				
Foraksel/Front axle/Vorneachse					
1	5013613 Venstre/Left/Links -5/97 Ch. -V3023597/-V4166925/-V6066279 Bærearmlenke/Track control arm/Querlenker	Nederste/Lower/Unten			1
2	5013614 Venstre/Left/Links -5/97 Ch. -V3023597/-V4166925/-V6066279 Bærearmlenke/Track control arm/Querlenker	Nederste/Lower/Unten			2
3	5013621 Venstre/Left/Links 5/97- Ch. V3023598/-V4166926/-V6066280- Bærearmlenke/Track control arm/Querlenker	Nederste/Lower/Unten			3
4	5013622 Venstre/Left/Links 5/97- Ch. V3023598/-V4166926/-V6066280- Bærearmlenke/Track control arm/Querlenker	Nederste/Lower/Unten			4
5	5033623 V/H - L/R -5/97 12x1,5 RHT Ch. -V3023597/-V4166925/-V6066279 Styrekugle/Tie rod end/Kugelgelenk	Yderste/Outer/Außen			5
6	5033644 V/H - L/R 12x1,5 RHT Styrekugle/Tie rod end/Axialgelenk	(*) Inderste/Inner			6
7	5033645 V/H - L/R 12x1,5 RHT Styrekugle/Tie rod end/Axialgelenk	(**) Inderste/Inner			7
8	5033656 V/H - L/R 5/97- Ch. V3023598/-V4166926/-V6066280- Styrekugle/Tie rod end/Kugelgelenk	12x1,5 Yderste/Outer/Außen			8
<p>(*) Uden servostyring Without Power Steering Ohne Servolenkung</p> <p>(**) Med servostyring With Power Steering Mit Servolenkung</p>					
POS					
9	5043622 V/H - L/R -5/97 Ch. -V3023597/-V4166925/-V6066279 Bærekugle/Ball joint/Radgelenk	Nederste/Lower/Unten			9
10	5043629 V/H - L/R 5/97- Ch. V3023598/-V4166926/-V6066280- Bærekugle/Ball joint/Radgelenk	Nederste bærekugle			10
11	5093608 (**) Manchetsæt/Boot kit/Manschetten satz				11
12	5103605 V/H - L/R Bøsning/Bushing/Buchsen				12
<p>(**) Med servostyring With Power Steering Mit Servolenkung</p>					

POS	 Corsa C 9/00-			
Foraksel/Front axle/Vorneachse				
1	5013623 Venstre/Left/Links Bærearml/Track control arm/Querlenker	Nederste/Lower/Unter		1
2	5013624 Højre/Right/Rechs Bærearml/Track control arm/Querlenker	Nederste/Lower/Unten		2
3	5033623 V/H - L/R Styrekugle/Tie rod end/Kugelgelenk	12x1,5 RHT Yderste/Outer/Außen		3
4	5033661 V/H - L/R Styrekugle/Tie rod end/Axialgelenk	12x1,5 RHT Inderste/Inner		4
5	5043632 V/H - L/R Bærekugle/Ball joint/Radgelenk	Nederste/Lower/Unten		5
6	5113609 V/H - L/R 244 mm. Stabilisatorstang/Stabilizer rod/Diagonalstrebe			6
POS	 Frontera A 3/92-10/98			
Foraksel/Front axle/Vorneachse				
1	5031410 V/H - L/R 14x1,5 LHT Styrekugle/Tie rod end/Axialgelenk	Konus/Cone 16,0 mm. Inderste/Inner		1
2	5031411 V/H - L/R 14x1,5 RHT Styrekugle/Tie rod end/Kugelgelenk	Konus/Cone 16,0 mm. Yderste/Outer/Außen		2
3	5043630 V/H - L/R -7/95 Bærekugle/Ball joint/Radgelenk	Ch. -SV720102 Øverste/Upper/Oben		3
4	5043631 V/H - L/R Bærekugle/Ball joint/Radgelenk	Nederste/Lower/Unten		4
5	5043633 V/H - L/R 8/95- Bærekugle/Ball joint/Radgelenk	Ch. SV720103- Øverste/Upper/Oben		5
6	5113613 Venstre/Left/Links Stabilisatorstang/Stabilizer rod/Diagonalstrebe	150 mm.		6
7	5113614 Højre/Right/Rechs Stabilisatorstang/Stabilizer rod/Diagonalstrebe	150 mm.		7











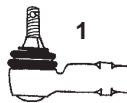

POS	Frontera B 10/98-				
Foraksel/Front axle/Vorneachse					
1	5043631 V/H - L/R Bærekugle/Ball joint/Radgelenk	Nederste/Lower/Unten		1	
2	5043633 V/H - L/R Bærekugle/Ball joint/Radgelenk	Øverste/Upper/Oben		2	
3	5113613 Venstre/Left/Links 150 mm. Stabilisatorstang/Stabilizer rod/Diagonalstrebe			3	
4	5113614 Højre/Right/Rechs 150 mm. Stabilisatorstang/Stabilizer rod/Diagonalstrebe			4	
POS	Kadett B 1968-69	(Ch-2262975)	(Ch-1656320)		
Foraksel/Front axle/Vorneachse					
1	5043602 V/H - L/R Bærekugle/Ball joint/Radgelenk	Øverste/Upper/Oben		1	
2	5043603 V/H - L/R Ch. -1234000 Bærekugle/Ball joint/Radgelenk	Nederste/Lower/Unten		2	
3	5093601 Manchetsæt/Boot kit/Manschetten satz			3	

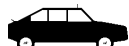
POS	 Kadett B 11/68-7/73			
Foraksel/Front axle/Vorneachse				
1	5033626 U V/H - L/R Styrekugle/Tie rod end/Axialgelenk	14X1,5 RHT Inderste/Inner		1
2	5043602 V/H - L/R Bærekugle/Ball joint/Radgelenk	Øverste/Upper/Oben		2
3	5043603 V/H - L/R Bærekugle/Ball joint/Radgelenk	Nederste/Lower/Unten		3
4	5093601 Manchetsæt/Boot kit/Manschetten satz			4
POS	 Kadett C & Kadett City 8/73-8/79			
Foraksel/Front axle/Vorneachse				
1	5013601 U Venstre/Left/Links Bærearmlenke/Track control arm/Querlenker	Øverste/Upper/Oben		1
2	5013602 U Højre/Right/Rechts Bærearmlenke/Track control arm/Querlenker	Øverste/Upper/Oben		2
3	5013603 U Venstre/Left/Links Bærearmlenke/Track control arm/Querlenker	Nederste/Lower/Unten		3
4	5013604 U Højre/Right/Rechts Bærearmlenke/Track control arm/Querlenker	Nederste/Lower/Unten		4
5	5023603 Tandstang/Steering rack/Zahnstange			5
6	5033603 V/H - L/R Styrekugle/Tie rod end/Kugelgelenk	14x1,5 Yderste/Outer/Außen		6
7	5033627 V/H - L/R Styrekugle/Tie rod end/Axialgelenk	14x1,5/14x1,5 Inderste/Inner		7
8	5043604 V/H - L/R (1.0 & 1.2) Bærekugle/Ball joint/Radgelenk	Nederste/Lower/Unten		8
9	5043605 V/H - L/R Bærekugle/Ball joint/Radgelenk	Øverste/Upper/Oben		9













POS	 Kadett C & Kadett City 8/73-8/79
Foraksel/Front axle/Vorneachse	
10	<p>5043608 U V/H - L/R (1.6, 1.9 & 2.0) Bærekugle/Ball joint/Radgelenk</p> <p>Nederste Bærekugle</p>  10
11	<p>5093602 Manchetsæt/Boot kit/Manschetten satz</p>  11
12	<p>5113602 V/H - L/R 170 mm. Stabilisatorbolt/Stabilizer bolt/Stabilisator bolzen</p>  12
POS	 Kadett D 9/79-9/81
Foraksel/Front axle/Vorneachse	
1	<p>5033622 V/H - L/R 16x1,5 Mellemlid/Intermediate link/Zwischenglied</p>  1
2	<p>5043606 V/H - L/R Bærekugle/Ball joint/Radgelenk</p> <p>Nederste/Lower/Unten</p>  2
3	<p>5093605 Manchetsæt/Boot kit/Manschetten satz</p>  3
4	<p>5113603 V/H - L/R Stabilisatorbolt/Stabilizer bolt/Stabilisator bolzen</p>  4

POS	Kadett D 10/81-8/84
Foraksel/Front axle/Vorneachse	
1	5013605 Venstre/Left/Links Bærearmlenke/Track control arm/Querlenker 
2	5013606 Højre/Right/Rechts Bærearmlenke/Track control arm/Querlenker 
3	5033608 Venstre/Left/Links 16x1,5 RHT Konus/Cone 15,0 Styrekugle/Tie rod end/Kugelgelenk Yderste/Outer/Außen 
4	5033609 Højre/Right/Rechts Styrekugle/Tie rod end/Kugelgelenk Yderste/Outer/Außen 
5	5033622 V/H - L/R 16x1,5 Justerbolt/Intermediate link/Zwischenglied 
6	5043607 V/H - L/R Bærekugle/Ball joint/Radgelenk Nederste/Lower/Unten 
7	5093605 Manchetsæt/Boot kit/Manschetten satz 
8	5113603 V/H - L/R 190 mm. Stabilisatorbolt/Stabilizer bolt/Stabilisator bolzen 
POS	Kadett E 9/84-2/93
Foraksel/Front axle/Vorneachse	
1	5003626 Venstre/Left/Links Styrestang/Steering rod/Spurstange 
2	5003629 Højre/Right/Rechts Styrestang/Steering rod/Spurstange 
3	5013605 Venstre/Left/Links Bærearmlenke/Track control arm/Querlenker 
4	5013606 Højre/Right/Rechts Bærearmlenke/Track control arm/Querlenker 
5	5033611 Venstre/Left/Links 16x1,5 RHT Styrekugle/Tie rod end/Kugelgelenk Yderste/Outer/Außen 
6	5033612 Højre/Right/Rechts 16x1,5 RHT Styrekugle/Tie rod end/Kugelgelenk Yderste/Outer/Außen 
7	5033622 V/H - L/R 16x1,5 Mellemlenke/Intermediate link/Zwischenglied 
8	5043607 V/H - L/R Bærekugle/Ball joint/Radgelenk Nederste/Lower/Unten 
9	5093605 Manchetsæt/Boot kit/Manschetten satz 







POS	Kadett E 9/84-2/93
Foraksel/Front axle/Vorneachse	
10	5103608 For/Front/Vorne V/H - L/R Bøsning/Bushing/Buchsen
11	5103609 Bag/Rear/Hinten V/H - L/R Bøsning/Bushing/Buchsen
12	5113603 V/H - L/R 190 mm. Stabilisatorbolt/Stabilizer bolt/Stabilisator bolzen
POS	Meriva 5/03-
Foraksel/Front axle/Vorneachse	
1	XXXXXXX Venstre/Left/Links Bærearmlenke/Track control arm/Querlenker Nederste/Lower/Unten
2	XXXXXXX Højre/Right/Rechts Bærearmlenke/Track control arm/Querlenker Nederste/Lower/Unten
3	5033665 V/H - L/R Styrekugle/Tie rod end/Kugelgelenk Yderste/Outer/Außen
4	5033666 V/H - L/R Styrekugle/Tie rod end/Axialgelenk Inderste/Inner
5	5113609 V/H - L/R 244 mm. Stabilisatorstang/Stabilizer rod/Diagonalstrebe





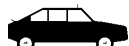











POS	 Monterey A & B 9/91-8/99			
		Foraksel/Front axle/Vorneachse		
1	5031410 V/H - L/R Styrekugle/Tie rod end/Axialgelenk	14x1,5 LHT Konus/Cone 16,0 mm. Inderste/Inner		
2	5031411 V/H - L/R Styrekugle/Tie rod end/Kugelgelenk	14x1,5 RHT Konus/Cone 16,0 mm. Yderste/Outer/Außen		
3	5043620 V/H - L/R 7/98- Bærekugle/Ball joint/Radgelenk	Nederste/Lower/Unten		
4	5043631 V/H - L/R -7/98 Bærekugle/Ball joint/Radgelenk	Nederste/Lower/Unten		
5	5043633 V/H - L/R Bærekugle/Ball joint/Radgelenk	Øverste/Upper/Oben		
		Foraksel/Front axle/Vorneachse		
POS	 Monza 2/78-8/86			
		Foraksel/Front axle/Vorneachse		
1	5003614 U Midt/Center/Mitte Styrestang/Steering rod/Spurstange			
2	5003615 U Midt/Center/Mitte (Diesel) Styrestang/Steering rod/Spurstange			
3	5033617 Mellemed/Intermediate link/Zwischenglied			
4	5033618 V/H - L/R Styrekugle/Tie rod end/Kugelgelenk	14x1,5 Yderste/Outer/Außen		
5	5033619 V/H - L/R Styrekugle/Tie rod end/Axialgelenk	14x1,5 Inderste/Inner		
6	5043620 V/H - L/R Bærekugle/Ball joint/Radgelenk	Nederste/Lower/Unten		
7	5113604 V/H - L/R Stabilisatorbolt/Stabilizer bolt/Stabilisator bolzen	140 mm.		
8	5113607 V/H - L/R Stabilisatorstang/Stabilizer rod/Diagonalstrebe	195 mm.		

POS	Movano 7/98-				
Foraksel/Front axle/Vorneachse					
1	5013921 Venstre/Left/Links Bærearml/Track control arm/Querlenker	(Stål/Steel/Stahl) Nederste/Lower/Unten			1
2	5013922 Højre/Right/Rechs Bærearml/Track control arm/Querlenker	(Stål/Steel/Stahl) Nederste/Lower/Unten			
3	5033941 Venstre/Left/Links Styrekugle/Tie rod end/Kugelgelenk	16x1,5 RHT Yderste/Outer/Außen			3
4	5033942 Højre/Right/Rechs Styrekugle/Tie rod end/Kugelgelenk	16x1,5 RHT Yderste/Outer/Außen			4
5	5033943 V/H - L/R Styrekugle/Tie rod end/Axialgelenk	16x1,5 RHT Inderste/Inner			5
6	5043926 V/H - L/R Bærekugle/Ball joint/Radgelenk	Nederste/Lower/Unten			6
7	5043930 V/H - L/R Bærekugle/Ball joint/Radgelenk	Øverste/Upper/Oben			7
8	5113615 Venstre/Left/Links Stabilisatorstang/Stabilizer rod/Diagonalstrebe	127 mm.			8
9	5113616 Højre/Right/Rechs Stabilisatorstang/Stabilizer rod/Diagonalstrebe	127 mm.			9
POS	Omega A 8/86-5/94				
Foraksel/Front axle/Vorneachse					
1	5003617 Midt/Center/Mitte 1.8/2.0/2.6/3.0 (**) Styrestang/Steering rod/Spurstange				1
2	5003627 Venstre/Left/Links Styrestang/Steering rod/Spurstange				2
3	5003628 Højre/Right/Rechs Styrestang/Steering rod/Spurstange				3
4	5033640 Venstre/Left/Links Styrekugle/Tie rod end/Kugelgelenk	Ch. H1169261- 14x1,5 RHT Yderste/Outer/Außen			4
5	5033641 Højre/Right/Rechs Styrekugle/Tie rod end/Kugelgelenk	Ch. H1169261- 14x1,5 LHT Yderste/Outer/Außen			5
6	5033642 Venstre/Left/Links Styrekugle/Tie rod end/Axialgelenk	Ch. H1169261- 14x1,5 LHT Inderste/Inner			6
7	5033643 Højre/Right/Rechs Styrekugle/Tie rod end/Axialgelenk	Ch. H1169261- 14x1,5 RHT Inderste/Inner			7
8	5033648 U V/H - L/R Mellemlid/Intermediate link/Zwischenglied	Ch. H1169261- 14x1,5			8
9	5043625 Venstre/Left/Links Bærekugle/Ball joint/Radgelenk	Nederste/Lower/Unten			9
					(**) Med servostyring With Power Steering Mit Servolenkung

POS	Omega A 8/86-5/94		
Foraksel/Front axle/Vorneachse			
10	5043626 Højre/Right/Rechs Bærekugle/Ball joint/Radgelenk	Nederste/Lower/Unten	 10
11	5103606 For/Front/Vorne Bøsning/Bushing/Buchsen	V/H - L/R	 11
12	5103607 Bag/Rear/Hinten Bøsning/Bushing/Buchsen	V/H - L/R	 12
13	5113622 V/H - L/R Stabilisatorstang/Stabilizer rod/Diagonalstrebe		 13
POS	Omega B 3/94-7/03		
Foraksel/Front axle/Vorneachse			
1	5003623 Midt/Center/Mitte Styrestang/Steering rod/Spurstange		 1
2	5003624 Venstre/Left/Links Styrestang/Steering rod/Spurstange		 2
3	5003625 Højre/Right/Rechs Styrestang/Steering rod/Spurstange		 3
4	5013625 Venstre/Left/Links Bæream/Track control arm/Querlenker	Nederste/Lower/Unten	 4
5	5013626 Højre/Right/Rechs Bæream/Track control arm/Querlenker	Nederste/Lower/Unten	 5
6	5033650 Venstre/Left/Links Styrekugle/Tie rod end/Kugelgelenk	14x1,5 RHT Yderste/Outer/Außen	 6
7	5033651 Højre/Right/Rechs Styrekugle/Tie rod end/Kugelgelenk	14x1,5 LHT Yderste/Outer/Außen	 7
8	5033652 Venstre/Left/Links Styrekugle/Tie rod end/Axialgelenk	14x1,5 RHT Inderste/Inner	 8
9	5033653 Højre/Right/Rechs Styrekugle/Tie rod end/Axialgelenk	14x1,5 LHT Inderste/Inner	 9

POS	 Omega B 3/94-7/03
Foraksel/Front axle/Vorneachse	
10	5043627 V/H - L/R Bærekugle/Ball joint/Radgelenk Nederste/Lower/Unten
11	5103615 For/Front/Vorne Bøsning/Bushing/Buchsen V/H - L/R
12	5103616 Bag/Rear/Hinten Bøsning/Bushing/Buchsen V/H - L/R
13	5113610 V/H - L/R Stabilisatorstang/Stabilizer rod/Diagonalstrebe 225 mm.
Bagaksel/Rear axle/Hinterachse	
14	5113619 Venstre/Left/Links Stabilisator/Stabilizer/Stabilisator
15	5113620 Højre/Right/Rechs Stabilisator/Stabilizer/Stabilisator
Foraksel/Front axle/Vorneachse	
1	5033613 V/H - L/R Ch. -4587549 Styrekugle/Tie rod end/Axialgelenk 14x1,5 RHT Inderste/Inner
2	5033614 V/H - L/R Ch. -4587549 Styrekugle/Tie rod end/Kugelgelenk 14x1,5 LHT Yderste/Outer/Außen



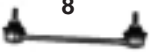







POS		Rekord C 9/69-12/71	
Foraksel/Front axle/Vorneachse			
1	5033613	V/H - L/R Ch. 4587550- Styrekugle/Tie rod end/Axialgelenk	14x1,5 RHT Inderste/Inner  1
2	5033614	V/H - L/R Ch. 4587550- Styrekugle/Tie rod end/Kugelgelenk	14x1,5 LHT Yderste/Outer/Außen  2
POS		Rekord D + Diesel 1/72-8/77	
Foraksel/Front axle/Vorneachse			
1	5033615 U	V/H - L/R Styrekugle/Tie rod end/Axialgelenk	14x1,5 RHT Konus/Cone 14,0 mm. Inderste/Inner  1
2	5033616 U	V/H - L/R Styrekugle/Tie rod end/Kugelgelenk	14x1,5 LHT Konus/Cone 14,0 mm. Yderste/Outer/Außen  2
3	5033617	V/H - L/R Gevindestykke/Intermediate link/Zwischenglied	 3
4	5113604	V/H - L/R Stabilisatorbolt/Stabilizer bolt/Stabilisator bolzen	140 mm.  4

POS	 Rekord E + Diesel 8/77-8/86
Foraksel/Front axle/Vorneachse	
1	5003614 U Midt/Center/Mitte Styrestang/Steering rod/Spurstange  1
2	5003615 U Midt/Center/Mitte (Diesel) Styrestang/Steering rod/Spurstange  2
3	5033617 V/H - L/R Gevindestykke/Intermediate link/Zwischenglied  3
4	5033618 V/H - L/R Styrekugle/Tie rod end/Kugelgelenk 14x1,5 Yderste/Outer/Außen  4
5	5033619 V/H - L/R Styrekugle/Tie rod end/Axialgelenk 14x1,5 Inderste/Inner  5
6	5043620 V/H - L/R Bærekugle/Ball joint/Radgelenk Nederste/Lower/Unten  6
7	5113604 V/H - L/R Stabilisatorbolt/Stabilizer bolt/Stabilisator bolzen 140 mm.  7
8	5113607 V/H - L/R Stabilisatorstang/Stabilizer rod/Diagonalstrebe 195 mm.  8
POS	 Senator A 2/78-8/87
Foraksel/Front axle/Vorneachse	
1	5003614 U Midt/Center/Mitte Styrestang/Steering rod/Spurstange  1
2	5003615 U Midt/Center/Mitte (Diesel) Styrestang/Steering rod/Spurstange  2
3	5033617 V/H - L/R Gevindestykke/Intermediate link/Zwischenglied  3
4	5033618 V/H - L/R Styrekugle/Tie rod end/Kugelgelenk 14x1,5 Yderste/Outer/Außen  4
5	5033619 V/H - L/R Styrekugle/Tie rod end/Axialgelenk 14x1,5 Inderste/Inner  5
6	5043620 V/H - L/R Bærekugle/Ball joint/Radgelenk Nederste/Lower/Unten  6
7	5113604 V/H - L/R Stabilisatorbolt/Stabilizer bolt/Stabilisator bolzen 140 mm.  7
8	5113607 V/H - L/R Stabilisatorstang/Stabilizer rod/Diagonalstrebe 195 mm.  8

POS	Senator B 9/87-9/93				
Foraksel/Front axle/Vorneachse					
1	5003617 Midt/Center/Mitte (**) Styrestang/Steering rod/Spurstange		1		
2	5003627 Venstre/Left/Links Styrestang/Steering rod/Spurstange		2		
3	5003628 Højre/Right/Rechs Styrestang/Steering rod/Spurstange		3		
4	5033640 Venstre/Left/Links Styrekugle/Tie rod end/Kugelgelenk	Ch. H1169261- 14x1,5 RHT Yderste/Outer/Außen		4	
5	5033641 Højre/Right/Rechs Styrekugle/Tie rod end/Kugelgelenk	Ch. H1169261- 14x1,5 LHT Yderste/Outer/Außen		5	
6	5033642 Venstre/Left/Links Styrekugle/Tie rod end/Axialgelenk	Ch. H1169261- 14x1,5 LHT Inderste/Inner		6	
7	5033643 Højre/Right/Rechs Styrekugle/Tie rod end/Axialgelenk	Ch. H1169261- 14x1,5 RHT Inderste/Inner		7	
8	5033648 U V/H - L/R Gevindestykke/Intermediate link/Zwischenglied	Ch. H1169261- 14x1,5		8	
9	5043625 Venstre/Left/Links Bærekugle/Ball joint/Radgelenk	Nederste/Lower/Unten		9	
10	5043626 Højre/Right/Rechs Bærekugle/Ball joint/Radgelenk	Nederste/Lower/Unten		10	(**) Med servostyring With Power Steering Mit Servolenkung
POS					
11	5103606 For/Front/Vorne Bøsning/Bushing/Buchsen	V/H - L/R		11	
12	5103607 Bag/Rear/Hinten Bøsning/Bushing/Buchsen	V/H - L/R		12	
13	5113622 V/H - L/R Stabilisatorstang/Stabilizer rod/Diagonalstrebe			13	



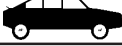







POS	Signum 5/03-				
Foraksel/Front axle/Vorneachse					
1	5013627 Venstre/Left/Links Bærearml/Track control arm/Querlenker	Nederste/Lower/Unten			
2	5013628 Højre/Right/Rechs Bærearml/Track control arm/Querlenker	Nederste/Lower/Unten			
3	5033667 Venstre/Left/Links Styrekugle/Tie rod end/Kugelgelenk	14x1,5 RHT Yderste/Outer/Außen			
4	5033668 Højre/Right/Rechs Styrekugle/Tie rod end/Kugelgelenk	14x1,5 RHT Yderste/Outer/Außen			
5	5113617 V/H - L/R Stabilisatorstang/Stabilizer rod/Diagonalstrebe	355 mm.			
Bagaksel/Rear axle/Hinterachse					
6	5013629 V/H - L/R Bærearml/Track control arm/Querlenker	Øverste/Upper/Oben			
7	5103621 Bag/Rear/Hinten Bøsning/Bushing/Buchsen	V/H - L/R			
8	5113618 V/H - L/R Stabilisatorstang/Stabilizer rod/Diagonalstrebe	86 mm.			
POS	Tigra 7/94-12/00				
Foraksel/Front axle/Vorneachse					
1	5013613 Venstre/Left/Links -6/97 Ch. -V3023597/-V4166925/-V6066279 Bærearml/Track control arm/Querlenker	Nederste/Lower/Unten			
2	5013614 Højre/Right/Rechs -6/97 Ch. -V3023597/-V4166925/-V6066279 Bærearml/Track control arm/Querlenker	Nederste/Lower/Unten			
3	5013621 Venstre/Left/Links 7/97- Ch. V3023598/-V4166926/-V6066280- Bærearml/Track control arm/Querlenker	Nederste/Lower/Unten			
4	5013622 Højre/Right/Rechs 7/97- Ch. V3023598/-V4166926/-V6066280- Bærearml/Track control arm/Querlenker	Nederste/Lower/Unten			
5	5033623 V/H - L/R -6/97 Ch. -V3023597/-V4166925/-V6066279 Styrekugle/Tie rod end/Kugelgelenk	Yderste/Outer/Außen			
6	5033644 V/H - L/R Styrekugle/Tie rod end/Axialgelenk	12x1,5 RHT (*) Inderste/Inner			(*) Uden servostyring Without Power Steering Ohne Servolenkung
7	5033645 V/H - L/R Styrekugle/Tie rod end/Axialgelenk	12x1,5 RHT (**) Inderste/Inner			(**) Med servostyring With Power Steering Mit Servolenkung

POS	Tigua 7/94-12/00				
Foraksel/Front axle/Vorneachse					
8	5033656 V/H - L/R 7/97- Ch. V3023598-/V4166926-/V6066280- Styrekugle/Tie rod end/Kugelgelenk	12x1,5			8
			Yderste/Outer/Außen		
9	5043622 V/H - L/R -6/97 Ch. -V3023597-/V4166925-/V6066279 Bærekugle/Ball joint/Radgelenk				9
			Nederste/Lower/Unten		
10	5043629 V/H - L/R 7/97- Ch. V3023598-/V4166926-/V6066280- Bærekugle/Ball joint/Radgelenk				10
			Nederste/Lower/Unten		
11	5093608 (**) Manchetsæt/Boot kit/Manschetten satz				11
12	5103605 V/H - L/R Bøsning/Bushing/Buchsen				12
(**) Med servostyring With Power Steering Mit Servolenkung					
POS	Vectra A 9/88-9/95				
Foraksel/Front axle/Vorneachse					
1	5003619 Venstre/Left/Links Styrestang/Steering rod/Spurstange				1
2	5003620 Højre/Right/Rechs Styrestang/Steering rod/Spurstange				2
3	5013607 Venstre/Left/Links Bærearm/Track control arm/Querlenker				3
4	5013608 Højre/Right/Rechs Bærearm/Track control arm/Querlenker				4
5	5033637 Venstre/Left/Links Styrekugle/Tie rod end/Kugelgelenk	16x2 RHT			5
			Yderste/Outer/Außen		
6	5033638 Højre/Right/Rechs Styrekugle/Tie rod end/Kugelgelenk	16x2 RHT			6
			Yderste/Outer/Außen		
7	5033639 V/H - L/R Mellemlid/Intermediate link/Zwischenglied	16x2			7
8	5043612 V/H - L/R Bærekugle/Ball joint/Radgelenk				8
			Nederste/Lower/Unten		
9	5093605 (*) Manchetsæt/Boot kit/Manschetten satz				9
(*) Uden servostyring Without Power Steering Ohne Servolenkung					

POS	 Vectra A 9/88-9/95			
Foraksel/Front axle/Vorneachse				
10	5093609 ZF (**) Manchetsæt/Boot kit/Manschetten satz		10	
11	5093610 Saginaw (**) Manchetsæt/Boot kit/Manschetten satz		11	
12	5103601 For/Front/Vorne Indvendig/Inner/Innen 12,0 mm. Bøsning/Bushing/Buchsen	V/H - L/R (O.E.352346)		12
13	5103602 Bag/Rear/Hinten -7/93 Indvendig/Inner/Innen 16,0 mm. Bøsning/Bushing/Buchsen	V/H - L/R (O.E.352348)		13
14	5103603 Bag/Rear/Hinten 7/93- Indvendig/Inner/Innen 16,0 mm. Bøsning/Bushing/Buchsen	V/H - L/R (O.E.352356)		14
15	5103699 V/H - L/R Bøsning/Bushing/Buchsen		15	
16	5113605 V/H - L/R Ch. -R1049313/-R5112256/-R7540515 Stabilisator/Stabilizer/Stabilisator	-1994 Ø22 mm. 83 mm.		16
17	5113606 V/H - L/R Ch. -R1049313/-R5112256/-R7540515 Stabilisator/Stabilizer/Stabilisator	-1994 Ø18 mm. 83 mm.		17
			(**) Med servostyring With Power Steering Mit Servolenkung	
POS				
18	5113608 V/H - L/R Ch. R5112257/-R7540516- Stabilisatorbolt/Stabilizer bolt/Stabilisator bolzen	1994- 85 mm. (O.E.350263)		18

POS	Vectra B 10/95-			
Foraksel/Front axle/Vorneachse				
1	5013615 Venstre/Left/Links Bærearml/Track control arm/Querlenker			1
2	5013616 Højre/Right/Rechs Bærearml/Track control arm/Querlenker			2
3	5033646 V/H - L/R Styrekugle/Tie rod end/Kugelgelenk	14x1,5 RHT Yderste/Outer/Außen		3
4	5033647 V/H - L/R Styrekugle/Tie rod end/Axialgelenk	(ZF) Inderste/Inner		4
5	5033654 V/H - L/R Styrekugle/Tie rod end/Axialgelenk	(Saginaw) Inderste/Inner		5
6	5043627 V/H - L/R Bærekugle/Ball joint/Radgelenk	Nederste/Lower/Unten		6
7	5093611 (Saginaw) Manchetsæt/Boot kit/Manschetten satz			7
8	5093612 (ZF) Manchetsæt/Boot kit/Manschetten satz			8
9	5103611 For/Front/Vorne Bøsning/Bushing/Buchsen	V/H - L/R		9
10	5103612 Bag/Rear/Hinten Bøsning/Bushing/Buchsen	V/H - L/R		10
POS				
11	5113609 V/H - L/R (O.E. 350 610) 244 mm. Stabilisatorstang/Stabilizer rod/Diagonalstrebe			11
Bagaksel/Rear axle/Hinterachse				
12	5103610 V/H - L/R Bøsning/Bushing/Buchsen	Nederste inderste/Lower inner/Unten innen		12
13	5103617 V/H - L/R Bøsning/Bushing/Buchsen	(4 stk./Pcs./Stück) Nederst yderst/Lower outer/Unten außen		13
14	5103618 V/H - L/R Bøsning t/stræberarm/Repair kit, radius link wheel suspension/ Reparatursatz, Führungsstrebe			14
15	5103619 For/Front/Vorne Bøsning/Bushing/Buchsen	V/H - L/R		15
16	5103620 Bag/Rear/Hinten Bøsning/Bushing/Buchsen	V/H - L/R		16







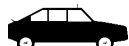







POS	Vectra C 4/02-
Foraksel/Front axle/Vorneachse	
1	5013627 Venstre/Left/Links Bærearml/Track control arm/Querlenker Nederste/Lower/Unten
2	5013628 Højre/Right/Rechs Bærearml/Track control arm/Querlenker Nederste/Lower/Unten
3	5013629 V/H - L/R Bærearml/Track control arm/Querlenker Øverste/Upper/Oben
4	5033667 Venstre/Left/Links 14x1,5 RHT Styrekugle/Tie rod end/Kugelgelenk Yderste/Outer/Außen
5	5033668 Højre/Right/Rechs 14x1,5 RHT Styrekugle/Tie rod end/Kugelgelenk Yderste/Outer/Außen
6	5033669 V/H - L/R 14x1,5 RHT Styrekugle/Tie rod end/Axialgelenk Inderste/Inner
7	5103621 Bag/Rear/Hinten V/H - L/R Bøsning/Bushing/Buchsen
8	5113617 V/H - L/R 355 mm. Stabilisatorstang/Stabilizer rod/Diagonalstrebe
9	5113618 V/H - L/R 86 mm. Stabilisatorstang/Stabilizer rod/Diagonalstrebe
POS	Vivaro 8/01-
Foraksel/Front axle/Vorneachse	
1	XXXXXX Venstre/Left/Links Bærearml/Track control arm/Querlenker Nederste/Lower/Unten
2	XXXXXX Højre/Right/Rechs Bærearml/Track control arm/Querlenker Nederste/Lower/Unten
3	5033662 V/H - L/R Styrekugle/Tie rod end/Axialgelenk Inderste/Inner
4	5033663 Venstre/Left/Links 12x1,5 Styrekugle/Tie rod end/Kugelgelenk Yderste/Outer/Außen
5	5033664 Højre/Right/Rechs 12x1,5 Styrekugle/Tie rod end/Kugelgelenk Yderste/Outer/Außen
6	5043634 V/H - L/R Bærekugle/Ball joint/Radgelenk Nederste/Lower/Unten
7	5113621 V/H - L/R 280 mm. Stabilisatorstang/Stabilizer rod/Diagonalstrebe

POS	 Zafira 4/99-		
Foraksel/Front axle/Vorneachse			
1	5013615 Venstre/Left/Links Bærearml/Track control arm/Querlenker		
2	5013616 Højre/Right/Rechs Bærearml/Track control arm/Querlenker		
3	5033655 V/H - L/R Styrekugle/Tie rod end/Kugelgelenk	14x1,5 RHT Yderste/Outer/Außen	
4	5033660 V/H - L/R Styrekugle/Tie rod end/Axialgelenk	(ZF) Inderste/Inner	
5	5043627 V/H - L/R Bærekugle/Ball joint/Radgelenk	Nederste/Lower/Unten	
6	5093613 Manchetsæt/Boot kit/Manschetten satz		
7	5103611 For/Front/Vorne Bøsning/Bushing/Buchsen	V/H - L/R	
8	5103612 Bag/Rear/Hinten Bøsning/Bushing/Buchsen	V/H - L/R	
9	5113611 V/H - L/R Stabilisatorstang/Stabilizer rod/Diagonalstrebe	300 mm.	
POS			











OPEL



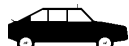



POS	
POS	









POS	104 3/79-6/88			
Foraksel/Front axle/Vorneachse				
1	5033702 V/H - L/R Styrekugle/Tie rod end/Kugelgelenk	Yderste/Outer/Außen		1
2	5041901 V/H - L/R Bærekugle/Ball joint/Radgelenk	Nederste/Lower/Unten		2
3	5093703 Manchetsæt/Boot kit/Manschetten satz			3
POS 106 I & II (- XSi) 9/91-				
Foraksel/Front axle/Vorneachse				
1	5003711 Venstre/Left/Links Styrestang/Steering rod/Spurstange			1
2	5003712 Højre/Right/Rechs Styrestang/Steering rod/Spurstange			2
3	5013705 Venstre/Left/Links Bærearmlenke/Track control arm/Querlenker	(Stål/Steel/Stahl) Nederste/Lower/Unten		3
4	5013706 Højre/Right/Rechs Bærearmlenke/Track control arm/Querlenker	(Stål/Steel/Stahl) Nederste/Lower/Unten		4
5	5031922 Venstre/Left/Links Styrekugle/Tie rod end/Axialgelenk	(*) 14x1,5 LHT Inderste/Inner		5
6	5031923 Højre/Right/Rechs Styrekugle/Tie rod end/Axialgelenk	(*) 14x1,5 LHT Inderste/Inner		6
7	5033717 Venstre/Left/Links Styrekugle/Tie rod end/Kugelgelenk	14x1,5 RHT Yderste/Outer/Außen		7
8	5033718 Højre/Right/Rechs Styrekugle/Tie rod end/Kugelgelenk	14x1,5 RHT Yderste/Outer/Außen		8
9	5043706 V/H - L/R Bærekugle/Ball joint/Radgelenk	Ø16 mm. Nederste/Lower/Unten		9
10	5093706 (1.0 & 1.1) Manchetsæt/Boot kit/Manschetten satz			10
				(*) Uden servostyring Without Power Steering Ohne Servolenkung

POS	106 I & II (- XSi) 9/91-
Foraksel/Front axle/Vorneachse	
11	5093707 (1.3/1.4/1.5D & 1.6) (*) Manchetsæt/Boot kit/Manschetten satz  11
12	5101910 For/Front/Vorne Bøsning/Bushing/Buchsen V/H - L/R  12
13	5101911 Bag/Rear/Hinten Bøsning/Bushing/Buchsen V/H - L/R  13
14	5111902 V/H - L/R 5/95- Ø12 mm. 355 mm. Stabilisatorstang/Stabilizer rod/Diagonalstrebe  4
15	5113701 V/H - L/R -5/95 345 mm. Stabilisatorstang/Stabilizer rod/Diagonalstrebe  15
(*) Uden servostyring Without Power Steering Ohne Servolenkung	
POS	106 I & II Xsi 9/91-
Foraksel/Front axle/Vorneachse	
1	5003713 Venstre/Left/Links Styrestang/Steering rod/Spurstange  1
2	5003714 Højre/Right/Rechs Styrestang/Steering rod/Spurstange  2
3	5013707 Venstre/Left/Links Bærearmlenke/Track control arm/Querlenker (Støbejern/Cast iron/Grauguß)  3
4	5013708 Højre/Right/Rechs Bærearmlenke/Track control arm/Querlenker (Støbejern/Cast iron/Grauguß)  4
5	5031924 Venstre/Left/Links Styrekugle/Tie rod end/Axialgelenk (**) 14x1,5 LHT Inderste/Inner  5
6	5031925 Højre/Right/Rechs Styrekugle/Tie rod end/Axialgelenk (**) 14x1,5 LHT Inderste/Inner  6
7	5033717 Venstre/Left/Links Styrekugle/Tie rod end/Kugelgelenk 14x1,5 RHT Yderste/Outer/Außen  7
8	5033718 Højre/Right/Rechs Styrekugle/Tie rod end/Kugelgelenk 14x1,5 RHT Yderste/Outer/Außen  8
9	5043706 V/H - L/R Bærekugle/Ball joint/Radgelenk Ø16 mm. Nederste/Lower/Unten  9
(**) Med Servostyring With Power Steering Mit Servolenkung	

POS	106 I & II Xsi 9/91-		
Foraksel/Front axle/Vorneachse			
10	5093707 (1.3/1.4/1.5D & 1.6) (*) Manchetsæt/Boot kit/Manschetten satz		10
11	5101910 For/Front/Vorne V/H - L/R Bøsning/Bushing/Buchsen		11
12	5101913 Bag/Rear/Hinten V/H - L/R Bøsning/Bushing/Buchsen		12
13	5111902 V/H - L/R 5/95- Ø12 mm. Stabilisatorstang/Stabilizer rod/Diagonalstrebe		13
14	5113701 V/H - L/R -5/95 345 mm. Stabilisatorstang/Stabilizer rod/Diagonalstrebe		14
			(*) Uden servostyring Without Power Steering Ohne Servolenkung
POS	205 2/83-9/98		
Foraksel/Front axle/Vorneachse			
1	5013701 Venstre/Left/Links (Ex. GTI) Bærearmlenke/Track control arm/Querlenker		1
2	5013702 Højre/Right/Rechs (Ex. GTI) Bærearmlenke/Track control arm/Querlenker		2
3	5013731 Venstre/Left/Links (GTI) Bærearmlenke/Track control arm/Querlenker		3
4	5013732 Højre/Right/Rechs (GTI) Bærearmlenke/Track control arm/Querlenker		4
5	5023706 Tandstang/Steering rack/Zahnstange		5
6	5033701 V/H - L/R Styrekugle/Tie rod end/Axialgelenk	14x1,5 RHT Inderste/Inner	
7	5033702 V/H - L/R Styrekugle/Tie rod end/Kugelgelenk	14x1,5 RHT Yderste/Outer/Außen	
8	5093703 (*) Manchetsæt/Boot kit/Manschetten satz		8
9	5093708 (**) Manchetsæt/Boot kit/Manschetten satz		9
			(*) Uden servostyring Without Power Steering Ohne Servolenkung
			(**) Med Servostyring With Power Steering Mit Servolenkung

POS	 205 2/83-9/98			
Foraksel/Front axle/Vorneachse				
10	5103702 For/Front/Vorne Bøsning/Bushing/Buchsen	V/H - L/R (Ex. GTI) (2 stk./Pcs./Stück)		10
11	5103703 Bag/Rear/Hinten Bøsning/Bushing/Buchsen	V/H - L/R (Ex. GTI)		11
12	5113704 V/H - L/R Stabilisatorstang/Stabilizer rod/Diagonalstrebe	(Gti) 358 mm.		12
POS	 206 9/98-			
Foraksel/Front axle/Vorneachse				
1	5013723 Venstre/Left/Links -9/02 Bærearmlenke/Track control arm/Querlenker	(Alle/All Ex. 1.6 16V/2.0 RC/2.0 S16)	Ch. -94440	
2	5013724 Højre/Right/Rechs -9/02 Bærearmlenke/Track control arm/Querlenker	(Alle/All Ex. 1.6 16V/2.0 RC/2.0 S16)	Ch. -94440	
3	5013741 Venstre/Left/Links Bærearmlenke/Track control arm/Querlenker	(Alle/All Ex. 1.6 16V/2.0 RC/2.0 S16)	Ch. 94441-	
4	5013742 Højre/Right/Rechs 10/02- Bærearmlenke/Track control arm/Querlenker	(Alle/All Ex. 1.6 16V/2.0 RC/2.0 S16)	Ch. 94441-	
5	5013743 Venstre/Left/Links Bærearmlenke/Track control arm/Querlenker	(1.6 16V/2.0 RC/2.0 S16)		
6	5013744 Højre/Right/Rechs Bærearmlenke/Track control arm/Querlenker	(1.6 16V/2.0 RC/2.0 S16)		
7	5033717 Højre/Right/Rechs Styrekugle/Tie rod end/Kugelgelenk	14x1,5 RHT Yderste/Outer/Außen		7
8	5033718 Venstre/Left/Links Styrekugle/Tie rod end/Kugelgelenk	14x1,5 RHT Yderste/Outer/Außen		8
9	5033724 V/H - L/R Styrekugle/Tie rod end/Axialgelenk	14x1,5 RHT Inderste/Inner		9

POS	 206 9/98-
Foraksel/Front axle/Vorneachse	
10	5093713 (**) Manchetsæt/Boot kit/Manschetten satz  10
11	5103711 For/Front/Vorne V/H - L/R Bøsning/Bushing/Buchsen  11
12	5103712 Bag/Rear/Hinten V/H - L/R Bøsning/Bushing/Buchsen  12
13	5113706 V/H - L/R 335 mm. Stabilisatorstang/Stabilizer rod/Diagonalstrebe Yderste/Outer/Außen  13
(**) Med Servostyring With Power Steering Mit Servolenkung	
POS	 207 2/06-
Foraksel/Front axle/Vorneachse	
1	5113717 Venstre/Left/Links Stabilisator/Stabilizer/Stabilisator
2	5113718 Højre/Right/Rechs Stabilisator/Stabilizer/Stabilisator

POS	 305 4/78-7/84
Foraksel/Front axle/Vorneachse	
1	<p>5033702 V/H - L/R 14x1,5 RHT  1</p> <p>Styrekugle/Tie rod end/Kugelgelenk Yderste/Outer/Außen</p>
2	<p>5093703  2</p> <p>Manchetsæt/Boot kit/Manschetten satz</p>
POS	 305 7/84-7/90
Foraksel/Front axle/Vorneachse	
1	<p>5033711 Venstre/Left/Links 14x1,5 RHT  1</p> <p>Styrekugle/Tie rod end/Kugelgelenk Yderste/Outer/Außen</p>
2	<p>5033712 Højre/Right/Rechs 14x1,5 RHT  2</p> <p>Styrekugle/Tie rod end/Kugelgelenk Yderste/Outer/Außen</p>
3	<p>5043705 V/H - L/R Ø38 mm. RHT  3</p> <p>Bærekugle/Ball joint/Radgelenk Nederste/Lower/Unten</p>
4	<p>5093708 (**)  4</p> <p>Manchetsæt/Boot kit/Manschetten satz</p>
<p>(**) Med Servostyring With Power Steering Mit Servolenkung</p>	

POS	306 3/93-3/97					
Foraksel/Front axle/Vorneachse						
1	5013709 Venstre/Left/Links Bærearml/Track control arm/Querlenker	(*)		1		
2	5013710 Højre/Right/Rechs Bærearml/Track control arm/Querlenker	(*)		2		
3	5013711 Venstre/Left/Links Bærearml/Track control arm/Querlenker	(**)		3		
4	5013712 Højre/Right/Rechs Bærearml/Track control arm/Querlenker	(**)		4		
5	5033702 V/H - L/R Styrekugle/Tie rod end/Kugelgelenk		14x1,5 RHT Yderste/Outer/Außen		5	
6	5033719 V/H - L/R Styrekugle/Tie rod end/Axialgelenk		14x1,5 RHT Inderste/Inner		6	
7	5043707 V/H - L/R (*) Bærekugle/Ball joint/Radgelenk		Ø16 mm. Nederste/Lower/Unten		7	
8	5043708 V/H - L/R (**) Bærekugle/Ball joint/Radgelenk		Ch. -7969 Ø16 mm. Nederste/Lower/Unten		8	
9	5093703 (*) Manchetsæt/Boot kit/Manschetten satz			9		(*) Uden servostyring Without Power Steering Ohne Servolenkung
10	5093708 (**) Manchetsæt/Boot kit/Manschetten satz			10		(**) Med Servostyring With Power Steering Mit Servolenkung
Bagaksel/Rear axle/Hinterachse						
11	5101905 Bag/Rear/Hinten V/H - L/R Bøsning/Bushing/Buchsen			11		
12	5101906 For/Front/Vorne V/H - L/R Bøsningssæt/Bushing set/Buchsen satz			12		
13	5111901 V/H - L/R 301 mm. Stabilisatorstang/Stabilizer rod/Diagonalstrebe			13		
14	5101925 Bag/Rear/Hinten V/H - L/R Bøsning/Bushing/Buchsen			14		
15	5101927 For/Front/Vorne Venstre/Left/Links Bøsning/Bushing/Buchsen			15		
16	5101928 For/Front/Vorne Højre/Right/Rechs Bøsning/Bushing/Buchsen			16		

POS	306 4/97-						
Foraksel/Front axle/Vorneachse							
1	5013709 Venstre/Left/Links (*) Bærearmlenke/Track control arm/Querlenker	-1/99	Ch. -7969	Ø16 mm.		1	
2	5013710 Højre/Right/Rechs (*) Bærearmlenke/Track control arm/Querlenker	-1/99	Ch. -7969	Ø16 mm.		3	
3	5013735 Venstre/Left/Links (*) Bærearmlenke/Track control arm/Querlenker	2/99-	Ch. 7970-	Ø18 mm.		5	
4	5013736 Højre/Right/Rechs (*) Bærearmlenke/Track control arm/Querlenker	2/99-	Ch. 7970-	Ø18 mm.		7	
5	5013711 Venstre/Left/Links (**) Bærearmlenke/Track control arm/Querlenker	-1/99	Ch. -7969	Ø16 mm.		9	
6	5013712 Højre/Right/Rechs (**) Bærearmlenke/Track control arm/Querlenker	-1/99	Ch. -7969	Ø16 mm.		10	
7	5013733 Venstre/Left/Links (**) Bærearmlenke/Track control arm/Querlenker	2/99-	Ch. 7970-	Ø18 mm.		11	
8	5013734 Højre/Right/Rechs (**) Bærearmlenke/Track control arm/Querlenker	2/99-	Ch. 7970-	Ø18 mm.		12	
9	5033702 V/H - L/R Styrekugle/Tie rod end/Kugelgelenk	14x1,5	RHT	Yderste/Outer/Außen		13	(*) Uden servostyring Without Power Steering Ohne Servolenkung
10	5033719 V/H - L/R Styrekugle/Tie rod end/Axialgelenk	14x1,5	RHT	Inderste/Inner		14	(**) Med Servostyring With Power Steering Mit Servolenkung
POS							
11	5043707 V/H - L/R (*) Bærekugle/Ball joint/Radgelenk	-1/99	Ch. -7969	Ø16 mm.		15	
12	5043708 V/H - L/R (**) Bærekugle/Ball joint/Radgelenk	-1/99	Ch. -7969	Ø16 mm.		16	
13	5043710 V/H - L/R (*) Bærekugle/Ball joint/Radgelenk	2/99-	Ch. 7970-	Ø18 mm.		17	
14	5043711 V/H - L/R (**) Bærekugle/Ball joint/Radgelenk	2/99-	Ch. 7970-	Ø18 mm.		18	
15	5093708 (**) Manchetsæt/Boot kit/Manschetten satz					19	
16	5101905 Bag/Rear/Hinten V/H - L/R Bøsning/Bushing/Buchsen					20	
17	5101906 For/Front/Vorne V/H - L/R Bøsningssæt/Bushing set/Buchsen satz					21	
18	5111901 V/H - L/R 301 mm. Stabilisatorstang/Stabilizer rod/Diagonalstrebe					22	(*) Uden servostyring Without Power Steering Ohne Servolenkung (**) Med Servostyring With Power Steering Mit Servolenkung







POS	307 10/01-			
Foraksel/Front axle/Vorneachse				
1	5013725 Venstre/Left/Links Bærearmlenke/Track control arm/Querlenker			
2	5013726 Højre/Right/Rechs Bærearmlenke/Track control arm/Querlenker			
3	5033717 Højre/Right/Rechs Styrekugle/Tie rod end/Kugelgelenk	14x1,5 RHT Org. -10310 Yderste/Outer/Außen		
4	5033718 Venstre/Left/Links Styrekugle/Tie rod end/Kugelgelenk	14x1,5 RHT Org. -10310 Yderste/Outer/Außen		
5	5033702 V/H - L/R 14x1,5 RHT Styrekugle/Tie rod end/Kugelgelenk	Org. 10311- Yderste/Outer/Außen		
6	5033725 V/H - L/R 14x1,5 RHT Styrekugle/Tie rod end/Axialgelenk	Org. -10310 Inderste/Inner		
7	5033731 V/H - L/R Styrekugle/Tie rod end/Axialgelenk	14x1,5 Org. 10311- Inderste/Inner		
8	5043712 V/H - L/R Bærekugle/Ball joint/Radgelenk	Nederste/Lower/Unten		
9	5103712 Bag/Rear/Hinten Bøsning/Bushing/Buchsen	V/H - L/R		
10	5103713 For/Front/Vorne Bøsning/Bushing/Buchsen	V/H - L/R		
11	5113710 V/H - L/R Stabilisatorbolt/Stabilizer bolt/Stabilisator bolzen	335 mm.		
POS 308 (4A_4C_) 9/07-				
Foraksel/Front axle/Vorneachse				
1	xxxxxxx Venstre/Left/Links Bærearmlenke/Track control arm/Querlenker			
2	xxxxxxx Højre/Right/Rechs Bærearmlenke/Track control arm/Querlenker			
3	xxxxxxx Venstre/Left/Links Styrekugle/Tie rod end/Kugelgelenk			
4	xxxxxxx Højre/Right/Rechs Styrekugle/Tie rod end/Kugelgelenk			
5	5103713 For/Front/Vorne Bøsning/Bushing/Buchsen	V/H - L/R		
6	5103712 Bag/Rear/Hinten Bøsning/Bushing/Buchsen	V/H - L/R		
7	5113710 V/H - L/R Stabilisator/Stabilizer/Stabilisator			
8	xxxxxxx V/H - L/R Styrekugle/Tie rod end/Axialgelenk			

POS	309 10/85-12/93		
Foraksel/Front axle/Vorneachse			
1	5013703 Venstre/Left/Links (Ex. GTI) Bærearml/Track control arm/Querlenker		1
2	5013704 Højre/Right/Rechs (Ex. GTI) Bærearml/Track control arm/Querlenker		2
3	5013729 U Venstre/Left/Links (GTI) Bærearml/Track control arm/Querlenker		3
4	5013730 U Højre/Right/Rechs (GTI) Bærearml/Track control arm/Querlenker		4
5	5023707 U -9/89 (*) Tandstang/Steering rack/Zahnstange		5
6	5033702 V/H - L/R Styrekugle/Tie rod end/Kugelgelenk	14x1,5 RHT Yderste/Outer/Außen	
7	5033706 V/H - L/R Styrekugle/Tie rod end/Axialgelenk	12x1,0 Inderste/Inner	
8	5093703 (*) Manchetsæt/Boot kit/Manschetten satz		8
9	5093708 (**) Manchetsæt/Boot kit/Manschetten satz		9
		(*) Uden servostyring Without Power Steering Ohne Servolenkung	
		(**) Med Servostyring With Power Steering Mit Servolenkung	
POS			

POS	309 10/85-12/93			
Foraksel/Front axle/Vorneachse				
10	5103702 For/Front/Vorne Bøsning/Bushing/Buchsen	V/H - L/R (Ex. Gti) (2 stk./Pcs./Stück)		10
11	5103704 Bag/Rear/Hinten Bøsning/Bushing/Buchsen	V/H - L/R		11
12	5103714 U For/Front/Vorne Bøsning/Bushing/Buchsen	V/H - L/R (Gti) (2 stk./Pcs./Stück)		12
13	5113704 V/H - L/R Stabilisatorstang/Stabilizer rod/Diagonalstrebe	(Gti) 358 mm.		13
POS 405 5/87-10/96				
Foraksel/Front axle/Vorneachse				
1	5013715 Venstre/Left/Links Bærearmlenke/Track control arm/Querlenker	-8/94 Ch. -71358279	Konus/Cone 13,7 mm.	
2	5013716 Højre/Right/Rechs Bærearmlenke/Track control arm/Querlenker	-8/94 Ch. -71358279	Konus/Cone 13,7 mm.	
3	5013727 Venstre/Left/Links Bærearmlenke/Track control arm/Querlenker	8/94- Ch. 71358280-	Konus/Cone 15,7 mm.	
4	5013728 Højre/Right/Rechs Bærearmlenke/Track control arm/Querlenker	8/94- Ch. 71358280-	Konus/Cone 15,7 mm.	
5	5023708 -1/93 (*) Tandstang/Steering rack/Zahnstange			
6	5033711 Venstre/Left/Links Styrekugle/Tie rod end/Kugelgelenk	14x1,5 RHT	Yderste/Outer/Außen	
7	5033712 Højre/Right/Rechs Styrekugle/Tie rod end/Kugelgelenk	14x1,5 RHT	Yderste/Outer/Außen	
8	5033713 V/H - L/R Styrekugle/Tie rod end/Axialgelenk	14x1,5 RHT	Inderste/Inner	
9	5043705 V/H - L/R Bærekugle/Ball joint/Radgelenk	-8/94 Ch. -71358279	Ø38 mm. RHT Nederste/Lower/Unten	
				(*) Uden servostyring Without Power Steering Ohne Servolenkung











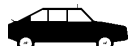

POS	405 5/87-10/96				
Foraksel/Front axle/Vorneachse					
10	5041912 V/H - L/R 9/94- Bærekugle/Ball joint/Radgelenk	Ch. 71358280- Ø40 mm. RHT Nederste/Lower/Unten			10
11	5091909 7/92- (**) Manchetsæt/Boot kit/Manschetten satz				11
12	5093709 (*) Manchetsæt/Boot kit/Manschetten satz				12
13	5093710 -7/92 (**) Manchetsæt/Boot kit/Manschetten satz				13
14	5103705 For/Front/Vorne Bøsning/Bushing/Buchsen	V/H - L/R			14
15	5103706 Bag/Rear/Hinten Bøsning/Bushing/Buchsen	V/H - L/R			15
16	5113703 V/H - L/R Stabilisatorstang/Stabilizer rod/Diagonalstrebe	Ø12 mm. 163 mm.			16
				(*) Uden servostyring Without Power Steering Ohne Servolenkung	
				(**) Med Servostyring With Power Steering Mit Servolenkung	
POS	406 10/95-				
Foraksel/Front axle/Vorneachse					
1	5013717 Venstre/Left/Links Bærearmlenke/Track control arm/Querlenker				1 2
2	5013718 Højre/Right/Rechts Bærearmlenke/Track control arm/Querlenker				
3	5033721 Venstre/Left/Links Styrekugle/Tie rod end/Kugelgelenk	16x1,5 RHT Yderste/Outer/Außen			3
4	5033722 Højre/Right/Rechts Styrekugle/Tie rod end/Kugelgelenk	16x1,5 RHT Yderste/Outer/Außen			4
5	5033723 V/H - L/R -4/99 Styrekugle/Tie rod end/Axialgelenk	16x1,5/12x1,0 RHT Inderste/Inner			5
6	5033726 V/H - L/R 5/99- Styrekugle/Tie rod end/Axialgelenk	16x1,5/16x1,5 RHT Inderste/Inner			6
7	5041912 V/H - L/R Bærekugle/Ball joint/Radgelenk	Ø40 mm. RHT Nederste/Lower/Unten			7
8	5093711 Manchetsæt/Boot kit/Manschetten satz				8
9	5103707 For/Front/Vorne Bøsning/Bushing/Buchsen	V/H - L/R			9



POS	406 10/95-			
10	5103708	Bag/Rear/Hinten	V/H - L/R	
		Bøsning/Bushing/Buchsen		
11	5111902	V/H - L/R -10/97 Ch. -7664	Ø12 mm. 355 mm.	
		Stabilisatorstang/Stabilizer rod/Diagonalstrebe		
12	5111903	V/H - L/R 11/97-	Ø12 mm. 355 mm.	
		Stabilisatorstang/Stabilizer rod/Diagonalstrebe		
Bagaksel/Rear axle/Hinterachse				
13	5103715	V/H - L/R	Ch. -07664	
		Bøsning/Bushing/Buchsen		
14	5113705	V/H - L/R	Ø10 mm. 165 mm.	
		Stabilisatorbolt/Stabilizer bolt/Stabilisator bolzen		
15	5113711	V/H - L/R	Ø10 mm. 245 mm.	
		Stabilisator/Stabilizer/Stabilisator		
POS	407 5/04-			
Foraksel/Front axle/Vorneachse				
1	5033730	V/H - L/R		
		Styrekugle/Tie rod end/Axialgelenk	Inderste/Inner	
2	5043713	V/H - L/R		
		Bærekugle/Ball joint/Radgelenk	Øverste/Upper/Oben	
3	5043714	V/H - L/R		
		Bærekugle/Ball joint/Radgelenk		
4	5113713	Venstre/Left/Links		
		Stabilisatorstang/Stabilizer rod/Diagonalstrebe		
5	5113714	Højre/Right/Rechs		
		Stabilisatorstang/Stabilizer rod/Diagonalstrebe		
Bagaksel/Rear axle/Hinterachse				
6	5113715			
		Stabilisatorarm/Stabilizer lever/Stabilisator hebel		

POS	 504 -12/79			
	Foraksel/Front axle/Vorneachse			
1	5033702 Venstre/Left/Links Styrekugle/Tie rod end/Kugelgelenk	14x1,5 RHT Yderste/Outer/Außen		 1
POS	 504 1/80-12/89			
	Foraksel/Front axle/Vorneachse			
1	5003704 U V/H - L/R Styrestang/Steering rod/Spurstange			 1
2	5033702 V/H - L/R Styrekugle/Tie rod end/Kugelgelenk	14x1,5 RHT Yderste/Outer/Außen		 2
3	5043702 V/H - L/R Bærekugle/Ball joint/Radgelenk	Nederste/Lower/Unten		 3
4	5093703 Manchetsæt/Boot kit/Manschetten satz			 4

POS	505 5/79-12/93 & 604 1/80-12/93			
Foraksel/Front axle/Vorneachse				
1	5033702 V/H - L/R Styrekugle/Tie rod end/Kugelgelenk	14x1,5 RHT Yderste/Outer/Außen		1
2	5033714 U V/H - L/R Styrekugle/Tie rod end/Axialgelenk	Inderste/Inner		2
3	5043702 V/H - L/R Bærekugle/Ball joint/Radgelenk	Nederste/Lower/Unten		3
4	5093703 Manchetsæt/Boot kit/Manschetten satz			4
POS	605 10/89-			
Foraksel/Front axle/Vorneachse				
1	5013719 Venstre/Left/Links (Ex. XU) Bærearm/Track control arm/Querlenker			1
2	5013720 Højre/Right/Rechs (Ex. XU) Bærearm/Track control arm/Querlenker			2
3	5013721 Venstre/Left/Links (XU) Bærearm/Track control arm/Querlenker			3
4	5013722 Højre/Right/Rechs (XU) Bærearm/Track control arm/Querlenker			4
5	5033717 Venstre/Left/Links Styrekugle/Tie rod end/Kugelgelenk	-1/95 14x1,5 RHT Yderste/Outer/Außen		5
6	5033718 Højre/Right/Rechs Styrekugle/Tie rod end/Kugelgelenk	-1/95 14x1,5 RHT Yderste/Outer/Außen		6
7	5033720 V/H - L/R Styrekugle/Tie rod end/Axialgelenk	-1/95 14x1,5 RHT Inderste/Inner		7
8	5033727 Venstre/Left/Links Styrekugle/Tie rod end/Kugelgelenk	2/95- 16x1,5 RHT Yderste/Outer/Außen		8
9	5033728 Højre/Right/Rechs Styrekugle/Tie rod end/Kugelgelenk	2/95- 16x1,5 RHT Yderste/Outer/Außen		9

POS	605 10/89-			
Foraksel/Front axle/Vorneachse				
10	5033732 V/H - L/R	Styrekugle/Tie rod end/Axialgelenk	2/95- 16x1,5 Ø22 mm.	Inderste/Inner
11	5041912 V/H - L/R	Bærekugle/Ball joint/Radgelenk	Ø40 mm. RHT	Nederste/Lower/Unten
12	5091909 -12/94	Manchetsæt/Boot kit/Manschetten satz		
13	5093711 1/95-	Manchetsæt/Boot kit/Manschetten satz		
14	5103607 For/Front/Vorne	Bøsning/Bushing/Buchsen	V/H - L/R	
15	5103710 Bag/Rear/Hinten	Bøsning/Bushing/Buchsen	V/H - L/R	
16	5113712 V/H - L/R	Stabilisatorstang/Stabilizer rod/Diagonalstrebe		
Bagaksel/Rear axle/Hinterachse				
17	5113707 Venstre/Left/Links	Stabilisatorarm/Stabilizer lever/Stabilisator hebel	86 mm.	
18	5113708 Højre/Right/Rechs	Stabilisatorarm/Stabilizer lever/Stabilisator hebel	86 mm.	
Foraksel/Front axle/Vorneachse				
1	5013719 Venstre/Left/Links	Bærearm/Track control arm/Querlenker		
2	5013720 Højre/Right/Rechs	Bærearm/Track control arm/Querlenker		
3	5033727 Venstre/Left/Links	Styrekugle/Tie rod end/Kugelgelenk	16x1,5 RHT	Yderste/Outer/Außen
4	5033728 Højre/Right/Rechs	Styrekugle/Tie rod end/Kugelgelenk	16x1,5 RHT	Yderste/Outer/Außen
5	5033729 V/H - L/R	Styrekugle/Tie rod end/Axialgelenk	16x1,5 RHT	Inderste/Inner
6	5041912 V/H - L/R	Bærekugle/Ball joint/Radgelenk	Ø40 mm. RHT	Nederste/Lower/Unten
7	5103607 For/Front/Vorne	Bøsning/Bushing/Buchsen	V/H - L/R	
8	5103710 Bag/Rear/Hinten	Bøsning/Bushing/Buchsen	V/H - L/R	
9	5111903 V/H - L/R	Stabilisatorstang/Stabilizer rod/Diagonalstrebe	Ø12 mm. 355 mm.	

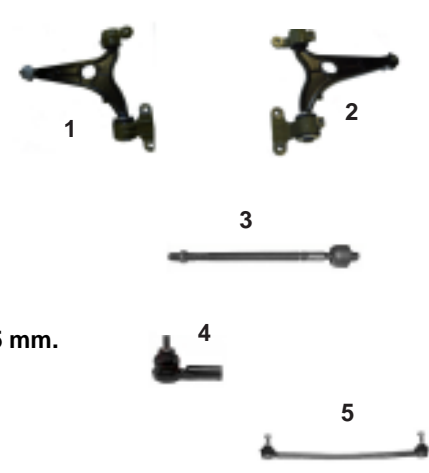
POS	 607 2/00-				
Bagaksel/Rear axle/Hinterachse					
10	5113707 Venstre/Left/Links	86 mm.			10
	Stabilisatorarm/Stabilizer lever/Stabilisator hebel				
11	5113708 Højre/Right/Rechs	86 mm.			11
	Stabilisatorarm/Stabilizer lever/Stabilisator hebel				
POS	 806 6/94-8/02				
Foraksel/Front axle/Vorneachse					
1	5011905 Venstre/Left/Links	(Støbejern/Cast iron/Grauguß)			1
	Bærearmlenke/Track control arm/Querlenker				
2	5011906 Højre/Right/Rechs	(Støbejern/Cast iron/Grauguß)			2
	Bærearmlenke/Track control arm/Querlenker				
3	5031916 V/H - L/R	14x1,5 RHT Konus/Cone 15 mm.			3
	Styrekugle/Tie rod end/Kugelgelenk				
4	5031917 V/H - L/R	M14x1,5 RHT			4
	Styrekugle/Tie rod end/Axialgelenk				
5	5093712				5
	Manchetsæt/Boot kit/Manschetten satz				
6	5101907 For/Front/Vorne	V/H - L/R			6
	Bøsning/Bushing/Buchsen				
7	5101908 Bag/Rear/Hinten	Venstre/Left/Links			7
	Bøsning/Bushing/Buchsen				
8	5101909 Bag/Rear/Hinten	Højre/Right/Rechs			8
	Bøsning/Bushing/Buchsen				
9	5112302 V/H - L/R	Ø12 mm. 120 mm.			9
	Stabilisator/Stabilizer/Stabilisator				





POS	 807 6/02-
Foraksel/Front axle/Vorneachse	
1	5011939 Venstre/Left/Links Bærearmlenke/Track control arm/Querlenker Nederste/Lower/Unten
2	5011940 Højre/Right/Rechs Bærearmlenke/Track control arm/Querlenker Nederste/Lower/Unten
3	5031936 V/H - L/R Styrekugle/Tie rod end/Axialgelenk Inderste/Inner
4	5031937 V/H - L/R Styrekugle/Tie rod end/Kugelgelenk 14x1,5 Konus/Cone 13,5 mm. Yderste/Outer/Außen
5	5111911 V/H - L/R Stabilisator/Stabilizer/Stabilisator 262,5 mm.
	
POS	 Bipper (AA_) 2/08
Foraksel/Front axle/Vorneachse	
1	5012365 Venstre/Left/Links Bærearmlenke/Track control arm/Querlenker
2	5012366 Højre/Right/Rechs Bærearmlenke/Track control arm/ Querlenker
3	xxxxxxx Venstre/Left/Links Styrekugle/Tie rod end/Kugelgelenk
4	xxxxxxx Højre/Right/Rechs Styrekugle/Tie rod end/Kugelgelenk
	

POS	Boxer (230) 3/94-4/02				
Foraksel/Front axle/Vorneachse					
1	5011909 Venstre/Left/Links Bæream/Track control arm/Querlenker	(1.0 - 1.4 T) -1/01			
2	5011910 Højre/Right/Rechs Bæream/Track control arm/Querlenker	(1.0 - 1.4 T) -1/01			
3	5011935 Venstre/Left/Links Bæream/Track control arm/Querlenker	(1.0 - 1.4 T) 2/01-			
4	5011936 Højre/Right/Rechs Bæream/Track control arm/Querlenker	(1.0 - 1.4 T) 2/01-			
5	5011911 Venstre/Left/Links Bæream/Track control arm/Querlenker	(1.8 T) -1/01			
6	5011912 Højre/Right/Rechs Bæream/Track control arm/Querlenker	(1.8 T) -1/01			
7	5011937 Venstre/Left/Links Bæream/Track control arm/Querlenker	(1.8 T) 2/01-			
8	5011938 Højre/Right/Rechs Bæream/Track control arm/Querlenker	(1.8 T) 2/01-			
9	5031918 V/H - L/R Styrekugle/Tie rod end/Kugelgelenk	16x1,5 RHT Yderste/Outer/Außen			
POS Boxer (230) 3/94-4/02					
Foraksel/Front axle/Vorneachse					
10	5031919 V/H - L/R Styrekugle/Tie rod end/Axialgelenk	16x1,5 RHT Inderste/Inner			
11	5041914 V/H - L/R Bærekugle/Ball joint/Radgelenk	(1.0 - 1.4 T) -1/01 Nederste/Lower/Unten			
12	5041921 V/H - L/R Bærekugle/Ball joint/Radgelenk	(1.0 - 1.4 T) 2/01- Nederste/Lower/Unten			
13	5041915 V/H - L/R Bærekugle/Ball joint/Radgelenk	(1.8 T) -1/01 Nederste/Lower/Unten			
14	5041922 V/H - L/R Bærekugle/Ball joint/Radgelenk	(1.8 T) 2/01- Nederste/Lower/Unten			
15	5092319 (**) Manchetsæt/Boot kit/Manschetten satz				
16	5102310 For/Front/Vorne Bøsning/Bushing/Buchsen	V/H - L/R			
17	5102311 Bag/Rear/Hinten Bøsning/Bushing/Buchsen	V/H - L/R			
18	5113707 V/H - L/R Stabilisatorarm/Stabilizer lever/Stabilisator hebel	86 mm.			(**) Med Servostyring With Power Steering Mit Servolenkung

POS	Boxer (244) 4/02-			
Foraksel/Front axle/Vorneachse				
1	5011935 Venstre/Left/Links Bærearmlenke/Track control arm/Querlenker	(1.0 - 1.4 T)		
2	5011936 Højre/Right/Rechts Bærearmlenke/Track control arm/Querlenker	(1.0 - 1.4 T)		
3	5011937 Venstre/Left/Links Bærearmlenke/Track control arm/Querlenker	(1.8 T)		
4	5011938 Højre/Right/Rechts Bærearmlenke/Track control arm/Querlenker	(1.8 T)		
5	5031918 V/H - L/R -12/02 Styreknude/Tie rod end/Kugelgelenk	16x1,5 RHT Yderste/Outer/Außen		
7	5031935 V/H - L/R 1/03- Styreknude/Tie rod end/Kugelgelenk	16x1,5 RHT Yderste/Outer/Außen		
6	5031919 V/H - L/R Styreknude/Tie rod end/Axialgelenk	16x1,5 RHT Inderste/Inner		
8	5041921 V/H - L/R Bærekugle/Ball joint/Radgelenk	(1.0 - 1.4 T) Nederste/Lower/Unten		
9	5041922 V/H - L/R Bærekugle/Ball joint/Radgelenk	(1.8 T) Nederste/Lower/Unten		
POS	Boxer (244) 4/02-			
Foraksel/Front axle/Vorneachse				
10	5102310 For/Front/Vorne V/H - L/R Bøsning/Bushing/Buchsen			
11	5102311 Bag/Rear/Hinten V/H - L/R Bøsning/Bushing/Buchsen			

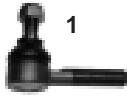





POS	Expert 2/96-				
Foraksel/Front axle/Vorneachse					
1	5011905 Venstre/Left/Links Bæream/Track control arm/Querlenker	(Støbejern/Cast iron/Grauguß)			
2	5011906 Højre/Right/Rechs Bæream/Track control arm/Querlenker	(Støbejern/Cast iron/Grauguß)			
3	5031916 V/H - L/R Styrekugle/Tie rod end/Kugelgelenk	14x1,5 RHT Konus/Cone 15 mm. Yderste/Outer/Außen			
4	5031917 V/H - L/R Styrekugle/Tie rod end/Axialgelenk	M14x1,5 RHT Inderste/Inner			
5	5093712 Manchetsæt/Boot kit/Manschetten satz				
6	5101907 For/Front/Vorne Bøsning/Bushing/Buchsen	V/H - L/R			
7	5101908 Bag/Rear/Hinten Bøsning/Bushing/Buchsen	Venstre/Left/Links			
8	5101909 Bag/Rear/Hinten Bøsning/Bushing/Buchsen	Højre/Right/Rechs			
9	5112302 V/H - L/R Stabilisator/Stabilizer/Stabilisator	Ø12 mm. 120 mm.			
POS J5 9/81-2/94					
Foraksel/Front axle/Vorneachse					
1	5011925 Venstre/Left/Links Bæream/Track control arm/Querlenker	(1.8 T)			
2	5011926 Højre/Right/Rechs Bæream/Track control arm/Querlenker	(1.8 T)			
3	5011927 Venstre/Left/Links Bæream/Track control arm/Querlenker	(1.0 - 1.4 T)			
4	5011928 Højre/Right/Rechs Bæream/Track control arm/Querlenker	(1.0 - 1.4 T)			
5	5032328 V/H - L/R Styrekugle/Tie rod end/Kugelgelenk	16x1,5 RHT Yderste/Outer/Außen			
6	5032338 V/H - L/R Styrekugle/Tie rod end/Axialgelenk	16x1,5 RHT Inderste/Inner			
7	5042309 V/H - L/R 9/85- Bærekugle/Ball joint/Radgelenk	Nederste/Lower/Unten			
8	5042310 V/H - L/R -9/85 Bærekugle/Ball joint/Radgelenk	Nederste/Lower/Unten			
9	5091910 (*) Manchetsæt/Boot kit/Manschetten satz				
					(*) Uden servostyring Without Power Steering Ohne Servolenkung







POS	Partner 6/96-			
Foraksel/Front axle/Vorneachse				
1	5011913 Venstre/Left/Links Bæream/Track control arm/Querlenker	(-2.0 HDi) (**)	Ch. -7972	Ø16 mm.
2	5011914 Højre/Right/Rechs Bæream/Track control arm/Querlenker	(-2.0 HDi) (**)	Ch. -7972	Ø16 mm.
3	5011915 Venstre/Left/Links Bæream/Track control arm/Querlenker	(-2.0 HDi) (*)	Ch. -7972	Ø16 mm.
4	5011916 Højre/Right/Rechs Bæream/Track control arm/Querlenker	(-2.0 HDi) (*)	Ch. -7972	Ø16 mm.
5	5011933 Venstre/Left/Links Bæream/Track control arm/Querlenker	(2.0 HDi)		
6	5011934 Højre/Right/Rechs Bæream/Track control arm/Querlenker	(2.0 HDi)		
7	5013737 Venstre/Left/Links Bæream/Track control arm/Querlenker	(-2.0 HDi) (**)	Ch. 7973-	Ø18 mm.
8	5013738 Højre/Right/Rechs Bæream/Track control arm/Querlenker	(-2.0 HDi) (**)	Ch. 7973-	Ø18 mm.
9	5013739 Venstre/Left/Links Bæream/Track control arm/Querlenker	(-2.0 HDi) (*)	Ch. 7973-	Ø18 mm.
			(*)	Uden servostyring Without Power Steering Ohne Servolenkung
			(**)	Med Servostyring With Power Steering Mit Servolenkung
Foraksel/Front axle/Vorneachse				
10	5013740 Højre/Right/Rechs Bæream/Track control arm/Querlenker	(-2.0 HDi) (*)	Ch. 7973-	Ø18 mm.
11	5031914 V/H - L/R Styrekugle/Tie rod end/Axialgelenk	14x1,5 RHT		
12	5033702 V/H - L/R Styrekugle/Tie rod end/Kugelgelenk	14x1,5 RHT		
13	5041916 V/H - L/R (*) Bærekugle/Ball joint/Radgelenk	Ch. -7972	Ø16 mm.	
14	5041917 V/H - L/R (**) Bærekugle/Ball joint/Radgelenk	Ch. -7972	Ø16 mm.	
15	5041918 V/H - L/R (*) Bærekugle/Ball joint/Radgelenk	Ch. 7973-	Ø18 mm.	
16	5041919 V/H - L/R (**) Bærekugle/Ball joint/Radgelenk	Ch. 7973-	Ø18 mm.	
17	5093708 (**) Manchetsæt/Boot kit/Manschetten satz			
18	5101905 Bag/Rear/Hinten Bøsning/Bushing/Buchsen	V/H - L/R		
19	5101906 For/Front/Vorne Bøsning/Bushing/Buchsen	V/H - L/R		
20	5111901 V/H - L/R Stabilisatorstang/Stabilizer rod/Diagonal	301 mm.		

POS	 Polonez 1981-
Foraksel/Front axle/Vorneachse	
1	<p>5032315 V/H - L/R Styrekugle/Tie rod end/Kugelgelenk</p> <p>16x1 LHT Yderste/Outer/Außen</p> 
2	<p>5032316 V/H - L/R Styrekugle/Tie rod end/Axialgelenk</p> <p>16x1 LHT Inderste/Inner</p>
3	<p>5042301 V/H - L/R Bærekugle/Ball joint/Radgelenk</p> <p>-1/85 Øverste/Upper/Oben</p> 
4	<p>5042302 V/H - L/R Bærekugle/Ball joint/Radgelenk</p> <p>-1/85 Nederste/Lower/Unten</p> 
POS	

POS	R4 1968-4/78 & R5 1973-4/78 & R6 1969-4/78
Foraksel/Front axle/Vorneachse	
1	5043901 V/H - L/R Bærekugle/Ball joint/Radgelenk Øverste/Upper/Oben
2	5043902 Venstre/Left/Links Bærekugle/Ball joint/Radgelenk Nederste/Lower/Unten
3	5043903 Højre/Right/Rechs Bærekugle/Ball joint/Radgelenk Nederste/Lower/Unten
4	5113901 V/H - L/R Stabolisatorbolt/Stabilizer bolt/Stabilisator bolzen Ø14 mm. 155 mm.
POS	R4 5/78-12/93 & R5 5/78-84 & R6 5/78-4/87
Foraksel/Front axle/Vorneachse	
1	5023903 U (R4 / R6) Tandstang/Steering rack/Zahnstange
2	5023904 U (R5) Tandstang/Steering rack/Zahnstange
3	5033901 V/H - L/R Styrekugle/Tie rod end/Kugelgelenk 14x1,5 RHT Konus/Cone 13,0 mm. Yderste/Outer/Außen
4	5043901 V/H - L/R Bærekugle/Ball joint/Radgelenk Øverste/Upper/Oben
5	5043902 Venstre/Left/Links Bærekugle/Ball joint/Radgelenk -9/81 Nederste/Lower/Unten
6	5043903 Højre/Right/Rechs Bærekugle/Ball joint/Radgelenk -9/81 Nederste/Lower/Unten
7	5043904 Venstre/Left/Links Bærekugle/Ball joint/Radgelenk 9/81- Nederste/Lower/Unten
8	5043905 U Højre/Right/Rechs Bærekugle/Ball joint/Radgelenk 9/81- Nederste/Lower/Unten
9	5093903 U Manchetsæt/Boot kit/Manschetten satz
10	5113901 V/H - L/R Stabolisatorbolt/Stabilizer bolt/Stabilisator bolzen Ø14 mm. 155 mm.











POS	R5 (Super 5) 10/84-12/96
Foraksel/Front axle/Vorneachse	
1	5013903 Venstre/Left/Links Bærearml/Track control arm/Querlenker
2	5013904 Højre/Right/Rechs Bærearml/Track control arm/Querlenker
3	5023912 12/88- Tandstang/Steering rack/Zahnstange
4	5033903 V/H - L/R Styrekugle/Tie rod end/Kugelgelenk
5	5033904 V/H - L/R Styrekugle/Tie rod end/Axialgelenk
6	5043919 V/H - L/R Bærekugle/Ball joint/Radgelenk
7	5093905 (*) Manchetsæt/Boot kit/Manschetten satz
	14x1,5 RHT Yderste/Outer/Außen
	14x1,5 RHT Inderste/Inner
	Nederste/Lower/Unten
	(*) Uden Servo Styling Without Power Steering Ohne Servolenkung
POS	R9/R11 9/81-7/89
Foraksel/Front axle/Vorneachse	
1	5033903 V/H - L/R Styrekugle/Tie rod end/Kugelgelenk
2	5043919 V/H - L/R Bærekugle/Ball joint/Radgelenk
3	5093905 Manchetsæt/Boot kit/Manschetten satz
	14x1,5 RHT Yderste/Outer/Außen
	Nederste/Lower/Unten













POS	 R12 9/69-8/80 & R15 7/71-10/80 & R17 7/71-10/80
	Foraksel/Front axle/Vorneachse
1	5043907 V/H - L/R Bærekugle/Ball joint/Radgelenk Øverste/Upper/Oben  1
2	5113901 V/H - L/R Ø14 mm. 155 mm. Stabolisatorbolt/Stabilizer bolt/Stabilisator bolzen  2
POS	 R14 5/76-12/83
	Foraksel/Front axle/Vorneachse
1	5033903 V/H - L/R 14x1,5 RHT Styrekugle/Tie rod end/Kugelgelenk Yderste/Outer/Außen  1
2	5041901 V/H - L/R Bærekugle/Ball joint/Radgelenk Nederste/Lower/Unten  2
3	5093903 U Manchetsæt/Boot kit/Manschetten satz  3













POS	 R16 1969-8/80
	Foraksel/Front axle/Vorneachse
1	<p>5093903 U Manchetsæt/Boot kit/Manschetten satz</p>  1
POS	 R18 R1340/R1341/R1349/R1350/R1351 1978-82
	Foraksel/Front axle/Vorneachse
1	<p>5033901 V/H - L/R Styrekugle/Tie rod end/Kugelgelenk</p> <p>14x1,5 RHT Konus/Cone 13,0 mm. Yderste/Outer/Außen</p>  1
2	<p>5043907 V/H - L/R Bærekugle/Ball joint/Radgelenk</p> <p>Øverste/Upper/Oben</p>  2
3	<p>5113901 V/H - L/R Ø14 mm. 155 mm. Stabolisatorbolt/Stabilizer bolt/Stabilisator bolzen</p>  3

POS	R19 11/88-1996		
Foraksel/Front axle/Vorneachse			
1	5013909 Venstre/Left/Links Bærearml/Track control arm/Querlenker		1
2	5013910 Højre/Right/Rechs Bærearml/Track control arm/Querlenker		2
3	5033913 Venstre/Left/Links Styrekugle/Tie rod end/Kugelgelenk	14x1,5 RHT Yderste/Outer/Außen	
4	5033914 Højre/Right/Rechs Styrekugle/Tie rod end/Kugelgelenk	14x1,5 RHT Yderste/Outer/Außen	
5	5033921 V/H - L/R Styrekugle/Tie rod end/Axialgelenk	14x1,5 RHT Inderste/Inner	
6	5043919 V/H - L/R Bærekugle/Ball joint/Radgelenk	Nederste/Lower/Unten	
7	5093905 Manchetsæt/Boot kit/Manschetten satz		
8	5103905 V/H - L/R Bøsning/Bushing/Buchsen		
POS Clio I 1/91-4/96			
Foraksel/Front axle/Vorneachse			
1	5013905 Venstre/Left/Links Bærearml/Track control arm/Querlenker		1
2	5013906 Højre/Right/Rechs Bærearml/Track control arm/Querlenker		2
3	5033915 Venstre/Left/Links Styrekugle/Tie rod end/Kugelgelenk	14x1,5 RHT Yderste/Outer/Außen	
4	5033916 Højre/Right/Rechs Styrekugle/Tie rod end/Kugelgelenk	14x1,5 RHT Yderste/Outer/Außen	
5	5033917 V/H - L/R Styrekugle/Tie rod end/Axialgelenk	14x1,5 RHT Inderste/Inner	
6	5043919 V/H - L/R Bærekugle/Ball joint/Radgelenk	Nederste/Lower/Unten	
7	5093905 Manchetsæt/Boot kit/Manschetten satz		
8	5103901 Bag/Rear/Hinten Bøsning/Bushing/Buchsen	V/H - L/R	
9	5103902 For/Front/Vorne Bøsning/Bushing/Buchsen	V/H - L/R	
10	5113902 V/H - L/R 74 mm. Stabilisatorbolt/Stabilizer bolt/Stabilisator bolzen		

POS	Clio I 4/96-9/98			
		Foraksel/Front axle/Vorneachse		
1	5013905 Venstre/Left/Links Bærearmlenke/Track control arm/Querlenker			
2	5013906 Højre/Right/Rechs Bærearmlenke/Track control arm/Querlenker			
3	5033927 Venstre/Left/Links Styrekugle/Tie rod end/Kugelgelenk	14x1,5 RHT Yderste/Outer/Außen		
4	5033928 Højre/Right/Rechs Styrekugle/Tie rod end/Kugelgelenk	14x1,5 RHT Yderste/Outer/Außen		
5	5033929 V/H - L/R Styrekugle/Tie rod end/Axialgelenk	14x1,5 RHT Inderste/Inner		
6	5043919 V/H - L/R Bærekugle/Ball joint/Radgelenk	Nederste/Lower/Unten		
7	5093905 Manchetsæt/Boot kit/Manschetten satz			
8	5103901 Bag/Rear/Hinten Bøsning/Bushing/Buchsen	V/H - L/R		
9	5103902 For/Front/Vorne Bøsning/Bushing/Buchsen	V/H - L/R		
10	5113902 V/H - L/R 74 mm. Stabilisatorbolt/Stabilizer bolt/Stabilisator bolzen			
POS	Clio II 9/98-			
		Foraksel/Front axle/Vorneachse		
1	5013911 Venstre/Left/Links Bærearmlenke/Track control arm/Querlenker	Nederste/Lower/Unten		
2	5013912 Højre/Right/Rechs Bærearmlenke/Track control arm/Querlenker	Nederste/Lower/Unten		
3	5033931 Venstre/Left/Links Styrekugle/Tie rod end/Kugelgelenk	-9/98 14x1,5 RHT Yderste/Outer/Außen		
4	5033932 Højre/Right/Rechs Styrekugle/Tie rod end/Kugelgelenk	-9/98 14x1,5 RHT Yderste/Outer/Außen		
5	5033933 V/H - L/R (**) Styrekugle/Tie rod end/Axialgelenk	-9/98 SMI 14x1,5 RHT Inderste/Inner		
6	5033936 V/H - L/R (**) Styrekugle/Tie rod end/Axialgelenk	-9/98 TRW 14x1,5 RHT Inderste/Inner		
7	5033937 V/H - L/R Styrekugle/Tie rod end/Axialgelenk	6/01- SMI 14x1,5 RHT Inderste/Inner		
8	5033945 Venstre/Left/Links Styrekugle/Tie rod end/Kugelgelenk	6/01- 14x1,5 RHT Yderste/Outer/Außen		
9	5033946 Højre/Right/Rechs Styrekugle/Tie rod end/Kugelgelenk	6/01- 14x1,5 RHT Yderste/Outer/Außen		
10	5043919 V/H - L/R Bærekugle/Ball joint/Radgelenk	Nederste/Lower/Unten		
				Med Servo Styling With Power Steering Mit Servolenkung



POS	Clio II 9/98-
Foraksel/Front axle/Vorneachse	
11	5093907 SMI (**) Manchetsæt/Boot kit/Manschetten satz  11
12	5093909 TRW (**) Manchetsæt/Boot kit/Manschetten satz  12
13	5103909 V/H - L/R Bøsning/Bushing/Buchsen  13
14	5113902 V/H - L/R 74 mm. Stabilisatorbolt/Stabilizer bolt/Stabilisator bolzen  14
(**) Med Servo Styling With Power Steering Mit Servolenkung	
POS	Clio III 6/05-
Foraksel/Front axle/Vorneachse	
1	5012223 Venstre/Left/Links Bærearmlenke/Track control arm/Querlenker  1
2	5012224 Højre/Right/Rechts Bærearmlenke/Track control arm/Querlenker  2
3	5033945 Venstre/Left/Links 14x1,5 Styrekugle/Tie rod end/Kugelgelenk Yderste/Outer/Außen
4	5033946 Højre/Right/Rechts 14x1,5 Styrekugle/Tie rod end/Kugelgelenk Yderste/Outer/Außen  3  4
5	5033961 V/H - L/R 14x1,5 RHT Styrekugle/Tie rod end/Axialgelenk Inderste/Inner
6	5042234 V/H - L/R Bærekugle/Ball joint/Radgelenk  6
7	5112218 V/H - L/R 247 mm. Stabilisatorstang/Stabilizer rod/Diagonalstrebe  7

POS	 Espace I J11 7/84-12/90
Foraksel/Front axle/Vorneachse	
1	5033903 V/H - L/R 14x1,5 RHT Styrekugle/Tie rod end/Kugelgelenk Yderste/Outer/Außen 
2	5093911 Manchetsæt/Boot kit/Manschetten satz 
3	5113909 V/H - L/R Stabilisatorstang/Stabilizer rod/Diagonalstrebe  
POS	 Espace II J63# 1/91-10/96
Foraksel/Front axle/Vorneachse	
1	5033903 V/H - L/R 14x1,5 RHT Styrekugle/Tie rod end/Kugelgelenk Yderste/Outer/Außen 
2	5033924 V/H - L/R 12x1,0 Styrekugle/Tie rod end/Axialgelenk Inderste/Inner 
3	5043927 V/H - L/R Bærekugle/Ball joint/Radgelenk Øverste/Upper/Oben 
4	5043928 V/H - L/R Bærekugle/Ball joint/Radgelenk Nederste/Lower/Unten 
5	5093911 Manchetsæt/Boot kit/Manschetten satz 
6	5113909 V/H - L/R Stabilisatorstang/Stabilizer rod/Diagonalstrebe  

















POS	Espace III JE_ 11/96-
Foraksel/Front axle/Vorneachse	
1	5013923 Venstre/Left/Links Bærearmlenke/Track control arm/Querlenker  1
2	5013924 Højre/Right/Rechs Bærearmlenke/Track control arm/Querlenker  2
3	5033947 Venstre/Left/Links 14x1,5 RHT Konus/Cone 14,6 mm. Styrekugle/Tie rod end/Kugelgelenk Yderste/Outer/Außen  3
4	5033948 Højre/Right/Rechs 14x1,5 RHT Konus/Cone 14,6 mm. Styrekugle/Tie rod end/Kugelgelenk Yderste/Outer/Außen  4
5	5033949 V/H - L/R Styrekugle/Tie rod end/Axialgelenk Inderste/Inner  5
6	5043929 V/H - L/R Bærekugle/Ball joint/Radgelenk Nederste/Lower/Unten  6
7	5093912 Manchetsæt/Boot kit/Manschetten satz
8	5103903 For/Front/Vorne V/H - L/R  8
9	5103908 Bag/Rear/Hinten Bøsning/Bushing/Buchsen  9
10	5113909 V/H - L/R Stabilisatorstang/Stabilizer rod/Diagonalstrebe
POS	Espace IV JKO_ 11/02-
Foraksel/Front axle/Vorneachse	
1	5033663 Venstre/Left/Links 12x1,5 Styrekugle/Tie rod end/Kugelgelenk Yderste/Outer/Außen  1
2	5033664 Højre/Right/Rechs 12x1,5 Styrekugle/Tie rod end/Kugelgelenk Yderste/Outer/Außen  2
3	5043634 V/H - L/R Bærekugle/Ball joint/Radgelenk Nederste/Lower/Unten  3
4	5113621 V/H - L/R 280 mm. Stabilisatorstang/Stabilizer rod/Diagonalstrebe  4

POS	Kangoo 2/98-				
Foraksel/Front axle/Vorneachse					
1	5013911 Venstre/Left/Links Bærearml/Track control arm/Querlenker	Nederste/Lower/Unten			1
2	5013912 Højre/Right/Rechs Bærearml/Track control arm/Querlenker	Nederste/Lower/Unten			2
3	5033934 Venstre/Left/Links Styrekugle/Tie rod end/Kugelgelenk	-2/99 14x1,5 RHT Yderste/Outer/Außen			3
4	5033935 Højre/Right/Rechs Styrekugle/Tie rod end/Kugelgelenk	-2/99 14x1,5 RHT Yderste/Outer/Außen			4
5	5033937 V/H - L/R (**) Styrekugle/Tie rod end/Axialgelenk	3/99- SMI 14x1,5 RHT Inderste/Inner			5
6	5033945 Venstre/Left/Links Styrekugle/Tie rod end/Kugelgelenk	3/99- 14x1,5 RHT Yderste/Outer/Außen			6
7	5033946 Højre/Right/Rechs Styrekugle/Tie rod end/Kugelgelenk	3/99- 14x1,5 RHT Yderste/Outer/Außen			7
8	5033950 V/H - L/R (**) Styrekugle/Tie rod end/Axialgelenk	-2/99 14x1,5 RHT Inderste/Inner			8
9	5033958 V/H - L/R TRW (*) Styrekugle/Tie rod end/Axialgelenk	340 mm. 14x1,5 RHT Inderste/Inner			
10	5033959 V/H - L/R (*) Styrekugle/Tie rod end/Axialgelenk	-9/99 264 mm. 14x1,5 RHT Inderste/Inner			
				(*)	Uden Servo Styling Without Power Steering Ohne Servolenkung
				(**)	Med Servo Styling With Power Steering Mit Servolenkung
POS					
11	5043919 V/H - L/R Bærerkugle/Ball joint/Radgelenk	Nederste/Lower/Unten			11
12	5093907 SMI (**) Manchetsæt/Boot kit/Manschetten satz				12
13	5103909 V/H - L/R Bøsning/Bushing/Buchsen				13
14	5113902 V/H - L/R 74 mm. Stabilisatorbolt/Stabilizer bolt/Stabilisator bolzen				14



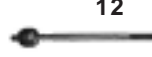
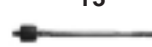
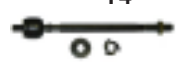

POS	Laguna I 11/93-3/01		
Foraksel/Front axle/Vorneachse			
1	5013913 Venstre/Left/Links Bærearml/Track control arm/Querlenker		1
2	5013914 Højre/Right/Rechs Bærearml/Track control arm/Querlenker		2
3	5033922 Venstre/Left/Links Styrekugle/Tie rod end/Kugelgelenk	14x1,5 RHT Yderste/Outer/Außen	
4	5033923 Højre/Right/Rechs Styrekugle/Tie rod end/Kugelgelenk	14x1,5 RHT Yderste/Outer/Außen	
5	5033930 V/H - L/R Styrekugle/Tie rod end/Axialgelenk	14x1,5 RHT Inderste/Inner	
6	5043920 V/H - L/R Bærekugle/Ball joint/Radgelenk	Nederste/Lower/Unten	
7	5093908 Manchetsæt/Boot kit/Manschetten satz		
8	5103903 For/Front/Vorne Bøsning/Bushing/Buchsen	V/H - L/R	
9	5103904 Bag/Rear/Hinten Bøsning/Bushing/Buchsen	V/H - L/R	
10	5113909 V/H - L/R Stabilisatorstang/Stabilizer rod/Diagonalstrebe		
POS	Laguna II 3/01- & Laguna Grandtour 3/01-		
Foraksel/Front axle/Vorneachse			
1	5013927 Venstre/Left/Links Bærearml/Track control arm/Querlenker		1
2	5013928 Højre/Right/Rechs Bærearml/Track control arm/Querlenker		2
3	5033663 Venstre/Left/Links Styrekugle/Tie rod end/Kugelgelenk	Yderste/Outer/Außen	
4	5033664 Højre/Right/Rechs Styrekugle/Tie rod end/Kugelgelenk	Yderste/Outer/Außen	
5	5033957 V/H - L/R Styrekugle/Tie rod end/Axialgelenk	14x1,5 RHT Inderste/Inner	
6	5043634 V/H - L/R Bærekugle/Ball joint/Radgelenk	Nederste/Lower/Unten	
7	5103903 For/Front/Vorne Bøsning/Bushing/Buchsen	V/H - L/R	
8	5103904 Bag/Rear/Hinten Bøsning/Bushing/Buchsen	V/H - L/R	
9	5113621 V/H - L/R Stabilisatorstang/Stabilizer rod/Diagonalstrebe	280 mm.	

POS	 Laguna III 10/07- & Laguna Grandtour 10/07-
	Foraksel/Front axle/Vorneachse
1	xxxxxxx Venstre/Left/Links Styrekugle/Tie rod end/Kugelgelenk Yderste/Outer/Außen
2	xxxxxxx Højre/Right/Rechs Styrekugle/Tie rod end/Kugelgelenk Yderste/Outer/Außen
3	xxxxxxx V/H - L/R Styrekugle/Tie rod end/Kugelgelenk Inderste/Inner
4	xxxxxxx V/H - L/R Stabilisator/Stabilizer rod/Diagonal strebe
POS	





POS	Master I 8/80-7/98			
Foraksel/Front axle/Vorneachse				
1	5043924 V/H - L/R Bærekugle/Ball joint/Radgelenk	Øverste/Upper/Oben		
2	5043925 V/H - L/R Bærekugle/Ball joint/Radgelenk	Nederste/Lower/Unten		
3	5113903 V/H - L/R Stabilisatorstang/Stabilizer rod/Diagonalstrebe	240 mm.		
Foraksel/Front axle/Vorneachse				
1	5013921 Venstre/Left/Links Bærearm/Track control arm/Querlenker	(Stål/Steel/Stahl)		
2	5013922 Højre/Right/Rechs Bærearm/Track control arm/Querlenker	(Stål/Steel/Stahl)		
3	5033941 Venstre/Left/Links Styrekugle/Tie rod end/Kugelgelenk	16x1,5 RHT Yderste/Outer/Außen		
4	5033942 Højre/Right/Rechs Styrekugle/Tie rod end/Kugelgelenk	16x1,5 RHT Yderste/Outer/Außen		
5	5033943 V/H - L/R Styrekugle/Tie rod end/Axialgelenk	16x1,5 RHT Inderste/Inner		
6	5043926 V/H - L/R Bærekugle/Ball joint/Radgelenk	Nederste/Lower/Unten		
7	5043930 V/H - L/R Bærekugle/Ball joint/Radgelenk	Øverste/Upper/Oben		
8	5093912 Manchetsæt/Boot kit/Manschetten satz			
9	5113615 Venstre/Left/Links Stabilisatorstang/Stabilizer rod/Diagonalstrebe	127 mm.		
10	5113616 Højre/Right/Rechs Stabilisatorstang/Stabilizer rod/Diagonalstrebe	127 mm.		

POS	 Megane I 1/96- & Megane Scenic 1/97-9/99			
Foraksel/Front axle/Vorneachse				
1	5013909 Venstre/Left/Links Bærearmlenke/Track control arm/Querlenker	(Stål/Steel/Stahl) (- Diesel -9/97 & Scenic -10/97/-2.0 16V) (Diesel 10/97- & Scenic 11/97-)		1
2	5013910 Højre/Right/Rechs Bærearmlenke/Track control arm/Querlenker	(Stål/Steel/Stahl) (- Diesel -9/97 & Scenic -10/97/-2.0 16V) (Diesel 10/97- & Scenic 11/97-)		2
3	5013917 Venstre/Left/Links Bærearmlenke/Track control arm/Querlenker	(Støbejern/Cast iron/Grauguß) (Diesel -9/97 & Scenic -10/97)		3
4	5013918 Højre/Right/Rechs Bærearmlenke/Track control arm/Querlenker	(Støbejern/Cast iron/Grauguß) (Diesel -9/97 & Scenic -10/97)		4
5	5013919 Venstre/Left/Links Bærearmlenke/Track control arm/Querlenker	(2.0 16V) (Stål/Steel/Stahl)		5
6	5013920 Højre/Right/Rechs Bærearmlenke/Track control arm/Querlenker	(2.0 16V) (Stål/Steel/Stahl)		6
7	5033938 Venstre/Left/Links Styrekugle/Tie rod end/Kugelgelenk	-2/00 14x1,5 RHT Yderste/Outer/Außen		7
8	5033939 Højre/Right/Rechs Styrekugle/Tie rod end/Kugelgelenk	-2/00 14x1,5 RHT Yderste/Outer/Außen		8
9	5033940 V/H - L/R -2/00 Styrekugle/Tie rod end/Axialgelenk	TRW 14x1,5 RHT Inderste/Inner		9
10	5033945 Venstre/Left/Links Styrekugle/Tie rod end/Axialgelenk	2/00- 14x1,5 RHT Yderste/Outer/Außen		10
POS				
11	5033946 Højre/Right/Rechs Styrekugle/Tie rod end/Kugelgelenk	2/00- 14x1,5 RHT Yderste/Outer/Außen		11
12	5033951 V/H - L/R Styrekugle/Tie rod end/Axialgelenk	2/00- TRW 14x1,5 RHT Inderste/Inner		12
13	5033952 V/H - L/R Styrekugle/Tie rod end/Axialgelenk	2/00- SMI 14x1,5 RHT Inderste/Inner		13
14	5033953 V/H - L/R Styrekugle/Tie rod end/Axialgelenk	3/99-2/00 SMI 14x1,5 RHT Inderste/Inner		14
15	5033960 V/H - L/R Styrekugle/Tie rod end/Axialgelenk	-2/99 SMI 14x1,5 RHT Inderste/Inner		16
16	5043919 V/H - L/R Bærekugle/Ball joint/Radgelenk	-9/97 1,4-1,4 16v-1,6-1,6 16v Diesel 10/97- & Scenic 11/97- 10mm Nederste/Lower/Unten		17
17	5043922 V/H - L/R Bærekugle/Ball joint/Radgelenk	Diesel -9/97 & Scenic -10/97 12mm Nederste/Lower/Unten		18
18	5043923 V/H - L/R Bærekugle/Ball joint/Radgelenk	1,8 16v-2,0-2.0 16V 10mm Nederste/Lower/Unten		
19	5043932 V/H - L/R Bærekugle/Ball joint/Radgelenk	Diesel 10/97- & Scenic 11/97- 12mm Nederste/Lower/Unten		





POS	Megane I 1/96- & Megane Scenic 1/97-9/99
Foraksel/Front axle/Vorneachse	
20	5093909 (- 2.0 16V) Manchetsæt/Boot kit/Manschetten satz
21	5093910 (2.0 16V) Manchetsæt/Boot kit/Manschetten satz
22	5103905 V/H - L/R (- 2.0 16V) Bøsning/Bushing/Buchsen
23	5113902 V/H - L/R 74 mm. Stabilisatorbolt/Stabilizer bolt/Stabilisator bolzen
POS	Megane II 11/02-
Foraksel/Front axle/Vorneachse	
1	5013925 Venstre/Left/Links Bæream/Track control arm/Querlenker
2	5013926 Højre/Right/Rechs Bæream/Track control arm/Querlenker
3	5033954 V/H - L/R 14x1,5 RHT Styrekugle/Tie rod end/Axialgelenk Inderste/Inner
4	5033955 Venstre/Left/Links 14x1,5 RHT Styrekugle/Tie rod end/Kugelgelenk Yderste/Outer/Außen
5	5033956 Højre/Right/Rechs 14x1,5 RHT Styrekugle/Tie rod end/Kugelgelenk Yderste/Outer/Außen
6	5043931 V/H - L/R Bærekugle/Ball joint/Radgelenk Nederste/Lower/Unten
7	5112520 V/H - L/R 285 mm. Stabilisatorstang/Stabilizer rod/Diagonalstrebe

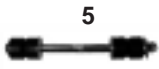



POS	 Modus (F/JPO_) 12/04-
Foraksel/Front axle/Vorneachse	
1	5012223 Venstre/Left/Links Bæream/Track control arm/Querlenker Nederste/Lower/Unten
2	5012224 Højre/Right/Rechs Bæream/Track control arm/Querlenker Nederste/Lower/Unten
3	5033945 Venstre/Left/Links 14x1,5 Styrekugle/Tie rod end/Kugelgelenk Yderste/Outer/Außen
4	5033946 Højre/Right/Rechs 14x1,5 Styrekugle/Tie rod end/Kugelgelenk Yderste/Outer/Außen
5	5033961 V/H - L/R 16x1,5 RHT Styrekugle/Tie rod end/Axialgelenk Inderste/Inner
6	5042234 V/H - L/R Bærekugle/Ball joint/Radgelenk
7	5112218 V/H - L/R 247 mm. Stabilisatorstang/Stabilizer rod/Diagonalstrebe
	
POS	 Rapid F40_,G40_ 7/85-3/98
Foraksel/Front axle/Vorneachse	
1	5013903 Venstre/Left/Links Bæream/Track control arm/Querlenker
2	5013904 Højre/Right/Rechs Bæream/Track control arm/Querlenker
3	5033903 V/H - L/R Styrekugle/Tie rod end/Kugelgelenk Yderste/Outer/Außen
4	5043919 V/H - L/R Bærekugle/Ball joint/Radgelenk Nederste/Lower/Unten
	

POS	Safrane I & II 4/92-12/00			
Foraksel/Front axle/Vorneachse				
1	5033925 V/H - L/R Styrekugle/Tie rod end/Kugelgelenk	14x1,5 RHT Yderste/Outer/Außen		1
2	5033926 V/H - L/R Styrekugle/Tie rod end/Kugelgelenk	14x1,5 RHT Yderste/Outer/Außen		2
3	5043921 V/H - L/R Bærekugle/Ball joint/Radgelenk	Nederste/Lower/Unten		3
4	5113909 V/H - L/R Stabilisatorstang/Stabilizer rod/Diagonalstrebe			4
POS Scenic (JA) 9/99-				
Foraksel/Front axle/Vorneachse				
1	5033945 Venstre/Left/Links Styrekugle/Tie rod end/Kugelgelenk	14x1,5 RHT Yderste/Outer/Außen		1
2	5033946 Højre/Right/Rechs Styrekugle/Tie rod end/Kugelgelenk	14x1,5 RHT Yderste/Outer/Außen		2
3	5033951 V/H - L/R TRW Styrekugle/Tie rod end/Axialgelenk	14x1,5 RHT Inderste/Inner		3
4	5033952 V/H - L/R SMI Styrekugle/Tie rod end/Axialgelenk	14x1,5 RHT Inderste/Inner		4
5	5043919 V/H - L/R Bærekugle/Ball joint/Radgelenk	Nederste/Lower/Unten		5
6	5093907 SMI (**) Manchetsæt/Boot kit/Manschetten satz			6
7	5113902 V/H - L/R Stabilisatorbolt/Stabilizer bolt/Stabilisator bolzen	74 mm.		7
(**) Med Servo Styring With Power Steering Mit Servolenkung				





POS	Scenic II (JM) 6/03-
Foraksel/Front axle/Vorneachse	
1	<p>5112520 V/H - L/R 285 mm. Stabilisatorstang/Stabilizer rod/Diagonalstrebe</p> 
POS	Trafic 9/80-3/01
Foraksel/Front axle/Vorneachse	
1	<p>5033910 V/H - L/R 14x1,5 RHT Konus/Cone 15,0 mm. Styrekugle/Tie rod end/Kugelgelenk Yderste/Outer/Außen</p> 
2	<p>5043916 V/H - L/R Bærekugle/Ball joint/Radgelenk Nederste/Lower/Unten</p> 
3	<p>5093906 (*) Manchetsæt/Boot kit/Manschetten satz</p> 
4	<p>5093911 (**) Manchetsæt/Boot kit/Manschetten satz</p> 
5	<p>5112207 V/H - L/R (**) 210 mm. Stabilisatorbolt/Stabilizer bolt/Stabilisator bolzen</p> 
	<p>(*) Uden Servo Styring Without Power Steering Ohne Servolenkung</p> <p>(**) Med Servo Styring With Power Steering Mit Servolenkung</p>







POS	Trafic 3/01-
Foraksel/Front axle/Vorneachse	
1	XXXXXX Venstre/Left/Links Bærearmlenke/Track control arm/Querlenker
2	XXXXXX Højre/Right/Rechs Bærearmlenke/Track control arm/Querlenker
3	5033662 V/H - L/R Styrekugle/Tie rod end/Axialgelenk Inderste/Inner
4	5033663 Venstre/Left/Links 12x1,5 Styrekugle/Tie rod end/Kugelgelenk Yderste/Outer/Außen
5	5033664 Højre/Right/Rechs 12x1,5 Styrekugle/Tie rod end/Kugelgelenk Yderste/Outer/Außen
6	5043634 V/H - L/R Bærekugle/Ball joint/Radgelenk Nederste/Lower/Unten
7	5093913 Manchetsæt/Boot kit/Manschetten satz
8	5113621 V/H - L/R 280 mm. Stabilisatorstang/Stabilizer rod/Diagonalstrebe
POS	Twingo 3/93-
Foraksel/Front axle/Vorneachse	
1	5013907 Venstre/Left/Links Bærearmlenke/Track control arm/Querlenker
2	5013908 Højre/Right/Rechs Bærearmlenke/Track control arm/Querlenker
3	5033918 Venstre/Left/Links 14x1,5 RHT Styrekugle/Tie rod end/Kugelgelenk Yderste/Outer/Außen
4	5033919 Højre/Right/Rechs 14x1,5 RHT Styrekugle/Tie rod end/Kugelgelenk Yderste/Outer/Außen
5	5033920 V/H - L/R 14x1,5 RHT Styrekugle/Tie rod end/Axialgelenk Inderste/Inner
6	5043919 V/H - L/R Bærekugle/Ball joint/Radgelenk Nederste/Lower/Unten
7	5093905 Manchetsæt/Boot kit/Manschetten satz
8	5113905 Venstre/Left/Links (CO6_) 9/00- Stabilisatorstang/Stabilizer rod/Diagonalstrebe
9	5113906 Højre/Right/Rechs (CO6_) 9/00- Stabilisatorstang/Stabilizer rod/Diagonalstrebe









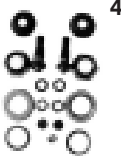



POS	 Vel Satis 6/02-	
1	Foraksel/Front axle/Vorneachse	
	5113621 V/H - L/R 280 mm. Stabilisatorstang/Stabilizer rod/Diagonalstrebe	 1
2	Bagaksel/Rear axle/Hinterachse	
	5113907 V/H - L/R Stabilisatorstang/Stabilizer rod/Diagonalstrebe	 2
POS		









POS	 Allegro 1973-82
Foraksel/Front axle/Vorneachse	
1	5031201 V/H - L/R UNF ½" x 20,0 RHT Konus/Cone 11,5 mm. Styrekugle/Tie rod end/Kugelgelenk Yderste/Outer/Außen
2	5091201 Manchetsæt/Boot kit/Manschetten satz
	
POS	 Maestro 1.3/1.6 + Van 1983- & Maestro 2.0 Diesel + Van 9/86- & Maestro 2.0 Efi 9/84-
Foraksel/Front axle/Vorneachse	
1	5031204 V/H - L/R 12x1,25 RHT Konus/Cone 12,5 mm. Styrekugle/Tie rod end/Kugelgelenk Yderste/Outer/Außen
	

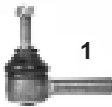
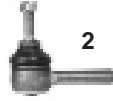





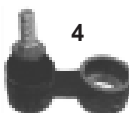



ROVER GROUP



POS	 Maxi 1500/1750 1968-82
Foraksel/Front axle/Vorneachse	
1	<p>5031201 V/H - L/R UNF ½" x 20,0 RHT Konus/Cone 11,5 mm.  1</p> <p>Styrekugle/Tie rod end/Kugelgelenk Yderste/Outer/Außen</p>
POS	 Metro 10/80-4/90
Foraksel/Front axle/Vorneachse	
1	<p>5031201 V/H - L/R UNF ½" x 20,0 RHT Konus/Cone 11,5 mm.  1</p> <p>Styrekugle/Tie rod end/Kugelgelenk Yderste/Outer/Außen</p>
2	<p>5041202 V/H - L/R 11/84-  2</p> <p>Bærekugle/Ball joint/Radgelenk Nederste/Lower/Unten</p>

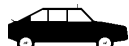

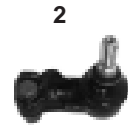



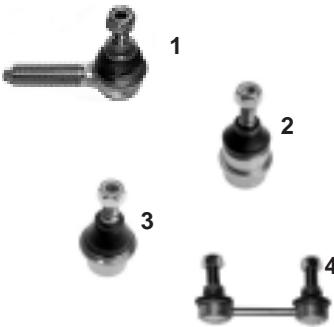



POS	 Metro 4/90-
Foraksel/Front axle/Vorne achse	
1	<p>5041202 V/H - L/R Bærekugle/Ball joint/Radgelenk</p> <p>Øverste/Upper/Oben</p>  1
POS	 Mini 850/1000, Clubman & Cooper 1959-
Foraksel/Front axle/Vorneachse	
1	<p>5031201 V/H - L/R Styrekugle/Tie rod end/Kugelgelenk</p> <p>UNF 1/2" x 20,0 RHT Konus/Cone 11,5 mm. Yderste/Outer/Außen</p>  1
2	<p>5041201 V/H - L/R Bærekugle/Ball joint/Radgelenk</p>  2
3	<p>5091201 Manchetsæt/Boot kit/Manschetten satz</p>  3
4	<p>5101201 U V/H - L/R Rep. sæt t/bærekugle/Repair kit for ball joint/Reparatursatz für radgelenk</p>  4

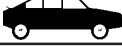







POS	 Mini One & Cooper 6/01-
Foraksel/Front axle/Vorneachse	
1	5014003 Venstre/Left/Links Bæream/Track control arm/Querlenker Nederste/Lower/Unten 
2	5014004 Højre/Right/Rechs Bæream/Track control arm/Querlenker Nederste/Lower/Unten 
3	5034010 V/H - L/R 14x1,5 Styrekugle/Tie rod end/Axialgelenk Inderste/Inner 
4	5034011 Venstre/Left/Links 14x1,5 Styrekugle/Tie rod end/Kugelgelenk Yderste/Outer/Außen 
5	5034012 Højre/Right/Rechs 14x1,5 Styrekugle/Tie rod end/Kugelgelenk Yderste/Outer/Außen 
6	5044001 V/H - L/R Bærekugle/Ball joint/Radgelenk Nederste/Lower/Unten 
7	5114007 V/H - L/R (Cooper s/One) Stabilisatorstang/Stabilizer rod/Diagonalstrebe 
8	5114008 V/H - L/R (Cooper) Stabilisatorstang/Stabilizer rod/Diagonalstrebe 
Bagaksel/Rear axle/Hinterachse	
9	5114009 V/H - L/R Stabilisatorstang/Stabilizer rod/Diagonalstrebe 
POS	 Montego 5/84-1992
Foraksel/Front axle/Vorneachse	
1	5031204 V/H - L/R 12x1,25 RHT Konus/Cone 12,5 mm. Styrekugle/Tie rod end/Kugelgelenk Yderste/Outer/Außen 





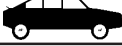

POS	Landrover Defender 10/95-
Foraksel/Front axle/Vorneachse	
1	5034004 Venstre/Left/Links Styrekugle/Tie rod end/Kugelgelenk Yderste/Outer/Außen 
2	5034005 Højre/Right/Rechs Styrekugle/Tie rod end/Kugelgelenk Yderste/Outer/Außen 
3	5044010 V/H - L/R Bærekugle/Ball joint/Radgelenk Nederste/Lower/Unten
4	5114001 V/H - L/R 65 mm. Stabilisatorbolt/Stabilizer bolt/Stabilisator bolzen 
Bagaksel/Rear axle/Hinterachse	
5	5114001 V/H - L/R 65 mm. Stabilisatorbolt/Stabilizer bolt/Stabilisator bolzen 
POS	Landrover Discovery I 9/89-9/98
Foraksel/Front axle/Vorneachse	
1	5004002 Midt/Center/Mitte Ch. -JA018174  1 Styrestang/Steering rod/Spurstange
2	5034004 Venstre/Left/Links Styrekugle/Tie rod end/Kugelgelenk Yderste/Outer/Außen 
3	5034005 Højre/Right/Rechs Styrekugle/Tie rod end/Kugelgelenk Yderste/Outer/Außen 
4	5114001 V/H - L/R 65 mm. Stabilisatorbolt/Stabilizer bolt/Stabilisator bolzen 
Bagaksel/Rear axle/Hinterachse	
5	5044010 V/H - L/R Bærekugle/Ball joint/Radgelenk  5
6	5114001 V/H - L/R 65 mm. Stabilisatorbolt/Stabilizer bolt/Stabilisator bolzen  6













POS	 Landrover Discovery II 10/98-
Foraksel/Front axle/Vorneachse	
1	5034013 V/H - L/R Styrekugle/Tie rod end/Kugelgelenk Yderste/Outer/Außen  1
2	5044011 V/H - L/R Bærekugle/Ball joint/Radgelenk Øverste/Upper/Oben  2
3	5044012 V/H - L/R Bærekugle/Ball joint/Radgelenk Nederste/Lower/Unten  3
4	5114002 V/H - L/R Stabilisatorstang/Stabilizer rod/Diagonalstrebe  4
Bagaksel/Rear axle/Hinterachse	
5	5114003 V/H - L/R Stabilisatorstang/Stabilizer rod/Diagonalstrebe  5
POS	 Landrover Freelander 10/97-
Foraksel/Front axle/Vorneachse	
1	5034017 Venstre/Left/Links Styrekugle/Tie rod end/Kugelgelenk Yderste/Outer/Außen  1
2	5034018 Højre/Right/Rechs Styrekugle/Tie rod end/Kugelgelenk Yderste/Outer/Außen  2
3	5044015 V/H - L/R Bærekugle/Ball joint/Radgelenk
4	5114004 V/H - L/R 220 mm. Stabilisatorstang/Stabilizer rod/Diagonalstrebe  4













POS	 Landrover Range Rover II 5/94-3/02
Foraksel/Front axle/Vorneachse	
1	5034013 V/H - L/R Styrekugle/Tie rod end/Kugelgelenk Yderste/Outer/Außen
2	5044011 V/H - L/R Bærekugle/Ball joint/Radgelenk Øverste/Upper/Oben
3	5044012 V/H - L/R Bærekugle/Ball joint/Radgelenk Nederste/Lower/Unten
4	5114005 V/H - L/R 75 mm. Stabilisatorbolt/Stabilizer bolt/Stabilisator bolzen
	
POS	 Rover 25 10/99-
Foraksel/Front axle/Vorneachse	
1	5112608 V/H - L/R 10 mm. 67 mm. Stabilisatorbolt/Stabilizer bolt/Stabilisator bolzen
	









POS	 Rover 45 2/00-
Foraksel/Front axle/Vorneachse	
1	5032606 Venstre/Left/Links Styrekugle/Tie rod end/Kugelgelenk Yderste/Outer/Außen  1
2	5032607 Højre/Right/Rechs Styrekugle/Tie rod end/Kugelgelenk Yderste/Outer/Außen  2
POS	 Rover 75 2/99-
Foraksel/Front axle/Vorneachse	
1	5014005 Venstre/Left/Links Bæream/Track control arm/Querlenker Nederste/Lower/Unten  1
2	5014006 Højre/Right/Rechs Bæream/Track control arm/Querlenker Nederste/Lower/Unten  2
3	5034015 Venstre/Left/Links 14x1,5 RHT Styrekugle/Tie rod end/Kugelgelenk Yderste/Outer/Außen  3
4	5034016 Højre/Right/Rechs 14x1,5 RHT Styrekugle/Tie rod end/Kugelgelenk Yderste/Outer/Außen  4
5	5104001 For/Front/Vorne Venstre/Left/Links Bøsning/Bushing/Buchsen
6	5104002 For/Front/Vorne Højre/Right/Rechs Bøsning/Bushing/Buchsen
7	5114006 V/H - L/R Stabilisatorstang/Stabilizer rod/Diagonalstrebe  7
Bagaksel/Rear axle/Hinterachse	
8	5114011 Venstre/Left/Links Stabilisatorstang/Stabilizer rod/Diagonalstrebe  8
9	5114012 Højre/Right/Rechs Stabilisatorstang/Stabilizer rod/Diagonalstrebe  9

POS	 Rover 214 - 216 - 218 - 220 10/89-				
		Foraksel/Front axle/Vorneachse			
1	5014001 Venstre/Left/Links Bæream/Track control arm/Querlenker	Nederste/Lower/Unten		1	
2	5014002 Højre/Right/Rechs Bæream/Track control arm/Querlenker	Nederste/Lower/Unten		2	
3	5034001 V/H - L/R Styrekugle/Tie rod end/Kugelgelenk	14x1,5 RHT Yderste/Outer/Außen			
4	5112608 V/H - L/R Stabilisatorbolt/Stabilizer bolt/Stabilisator bolzen	10 mm. 67 mm.		4	
POS	 Rover 414 - 416 - 418 - 420 10/89-				
		Foraksel/Front axle/Vorneachse			
1	5014001 Venstre/Left/Links Bæream/Track control arm/Querlenker	Nederste/Lower/Unten		1	
2	5014002 Højre/Right/Rechs Bæream/Track control arm/Querlenker	Nederste/Lower/Unten		2	
3	5034001 V/H - L/R Styrekugle/Tie rod end/Kugelgelenk	14x1,5 RHT Yderste/Outer/Außen		3	
4	5112608 V/H - L/R Stabilisatorbolt/Stabilizer bolt/Stabilisator bolzen	10 mm. 67 mm.			

POS	 Rover 400 (RT) 5/95-3/00
Foraksel/Front axle/Vorneachse	
1	5032606 Venstre/Left/Links Styrekugle/Tie rod end/Kugelgelenk 14x1,5 RHT Yderste/Outer/Außen
	 1
2	5032607 Højre/Right/Rechs Styrekugle/Tie rod end/Kugelgelenk 14x1,5 RHT Yderste/Outer/Außen
	 2
POS	 Rover 620-623 8/93-2/99
Foraksel/Front axle/Vorneachse	
1	5032610 Venstre/Left/Links Styrekugle/Tie rod end/Kugelgelenk 14x1,5 RHT Konus/Cone 13 mm. Yderste/Outer/Außen
	 1
2	5032611 Højre/Right/Rechs Styrekugle/Tie rod end/Kugelgelenk 14x1,5 RHT Konus/Cone 13 mm. Yderste/Outer/Außen
	 2
3	5042603 V/H - L/R Bærekugle/Ball joint/Radgelenk Nederste/Lower/Unten
	 3

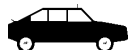
POS	 9.3 2/98- & 9.3 Cabriolet 2/98-			
Foraksel/Front axle/Vorneachse				
1	5003619 Venstre/Left/Links Styrestang/Steering rod/Spurstange			 1
2	5003620 Højre/Right/Rechs Styrestang/Steering rod/Spurstange			 2
3	5033637 Venstre/Left/Links Styrekugle/Tie rod end/Kugelgelenk	16x2 RHT Yderste/Outer/Außen		 3
4	5033638 Højre/Right/Rechs Styrekugle/Tie rod end/Kugelgelenk	16x2 RHT Yderste/Outer/Außen		 4
5	5095001 Manchetsæt/Boot kit/Manschetten satz			
6	5113608 V/H - L/R Stabilisator bolt/Stabilizer bolt/Stabilisator bolzen	85 mm.		 6
7	5113608 V/H - L/R - 9/02 Stabilisator bolt/Stabilizer bolt/Stabilisator bolzen	85 mm.		 7
POS	 9.3 (YS3F) & 9.3 Combi 9/02-			
Foraksel/Front axle/Vorneachse				
1	5013627 Venstre/Left/Links Bærearmlenke/Track control arm/Querlenker		Nederste/Lower/Unten	 1
2	5013628 Højre/Right/Rechs Bærearmlenke/Track control arm/Querlenker		Nederste/Lower/Unten	 2
3	5033667 Venstre/Left/Links Styrekugle/Tie rod end/Kugelgelenk	14x1,5 RHT Yderste/Outer/Außen		 3
4	5033668 Højre/Right/Rechs Styrekugle/Tie rod end/Kugelgelenk	14x1,5 RHT Yderste/Outer/Außen		 4

POS	 9.5 9/97-
Foraksel/Front axle/Vorneachse	
1	5033667 Venstre/Left/Links Styrekugle/Tie rod end/Kugelgelenk 14x1,5 RHT Yderste/Outer/Außen  1
2	5033668 Højre/Right/Rechs Styrekugle/Tie rod end/Kugelgelenk 14x1,5 RHT Yderste/Outer/Außen  2
3	5034113 V/H - L/R Styrekugle/Tie rod end/Kugelgelenk 14x1,5 RHT Konus/Cone 13mm. Yderste/Outer/Außen  3
4	5034114 V/H - L/R Styrekugle/Tie rod end/Axialgelenk 14x1,5 RHT Inderste/Inner  4
5	5044105 V/H - L/R Bærekugle/Ball joint/Radgelenk Nederste/Lower/Unten  5
6	5094107 Manchetsæt/Boot kit/Manschetten satz
7	5113609 V/H - L/R 244 mm. Stabilisatorstang/Stabilizer rod/Diagonalstrebe  7
POS	 95/96 10/65-8/80
Foraksel/Front axle/Vorneachse	
1	5034101 V/H - L/R Styrekugle/Tie rod end/Kugelgelenk 9/16x18 UNF RHT Yderste/Outer/Außen  1
2	5044101 V/H - L/R Bærekugle/Ball joint/Radgelenk  2
POS	 99 1968-9/74
Foraksel/Front axle/Vorneachse	
1	5044102 V/H - L/R Bærekugle/Ball joint/Radgelenk  1

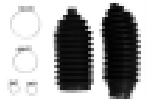
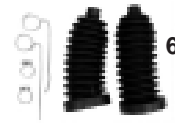



















POS	 90 1984-85 & 99 10/74-12/84			
Foraksel/Front axle/Vorneachse				
1	5034103 V/H - L/R Styrekugle/Tie rod end/Kugelgelenk	14x2 RHT Yderste/Outer/Außen		1
2	5044102 V/H - L/R Bærekugle/Ball joint/Radgelenk			2
3	5094104 U Manchetsæt/Boot kit/Manschetten satz			3
POS  900 I 11/78-6/94				
Foraksel/Front axle/Vorneachse				
1	5034103 V/H - L/R Styrekugle/Tie rod end/Kugelgelenk	14x2 RHT Yderste/Outer/Außen		1
2	5034106 V/H - L/R Styrekugle/Tie rod end/Axialgelenk	14x2 RHT Inderste/Inner		2
3	5034107 U V/H - L/R Styrekugle/Tie rod end/Axialgelenk	14x2 RHT Inderste/Inner		3
4	5044102 V/H - L/R Bærekugle/Ball joint/Radgelenk			4
5	5094104 U Manchetsæt/Boot kit/Manschetten satz			5
6	5094105 Manchetsæt/Boot kit/Manschetten satz			6







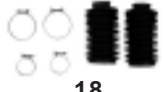

POS	900 II 7/93-2/98			
Foraksel/Front axle/Vorneachse				
1	5003619 Venstre/Left/Links Styrestang/Steering rod/Spurstange	Inderste/Inner		
2	5003620 Højre/Right/Rechs Styrestang/Steering rod/Spurstange	Inderste/Inner		
3	5033637 Venstre/Left/Links Styrekugle/Tie rod end/Kugelgelenk	16x2 RHT Yderste/Outer/Außen		
4	5033638 Højre/Right/Rechs Styrekugle/Tie rod end/Kugelgelenk	16x2 RHT Yderste/Outer/Außen		
5	5094105 Manchetsæt/Boot kit/Manschetten satz			
6	5113605 V/H - L/R Stabilisator/Stabilizer/Stabilisator	Ø22mm. 83 mm.		
POS	9000 9/84-12/98			
Foraksel/Front axle/Vorneachse				
1	5034105 V/H - L/R Styrekugle/Tie rod end/Kugelgelenk	14x1,5 RHT Yderste/Outer/Außen		
2	5034108 V/H - L/R Styrekugle/Tie rod end/Kugelgelenk	14x1,5 RHT Inderste/Inner		
3	5044103 V/H - L/R Bærekugle/Ball joint/Radgelenk	Nederste/Lower/Unten		
4	5094106 Manchetsæt/Boot kit/Manschetten satz			
5	5114101 V/H - L/R Stabilisator bolt/Stabilizer bolt/Stabilisator bolzen	110 mm.		









POS	Alhambra 4/96-				
Foraksel/Front axle/Vorneachse					
1	5002503 Venstre/Left/Links Styrestang/Steering rod/Spurstange	CH. 7MT005001-		1	
2	5002504 Højre/Right/Rechs Styrestang/Steering rod/Spurstange	CH. 7MT005001-		2	
3	5012533 Venstre/Left/Links Bærearml/Track control arm/Querlenker	Nederste/Lower/Unten		3	
4	5012534 Højre/Right/Rechs Bærearml/Track control arm/Querlenker	Nederste/Lower/Unten		4	
5	5032541 Venstre/Left/Links Styrekugle/Tie rod end/Kugelgelenk	14x1,5 RHT CH. 7MT005001- Yderste/Outer/Außen		5	
6	5032542 Højre/Right/Rechs Styrekugle/Tie rod end/Kugelgelenk	14x1,5 RHT CH. 7MT005001- Yderste/Outer/Außen		6	
7	5032543 V/H - L/R 14x1,5 RHT Styrekugle/Tie rod end/Axialgelenk	Inderste/Inner		7	
8	5044733 V/H - L/R Bærekugle/Ball joint/Radgelenk	Nederste/Lower/Unten		8	
9	5092316 Manchetsæt/Boot kit/Manschetten satz			9	
10	5102514 Bag/Rear/Hinten Bøsning/Bushing/Buchsen	V/H - L/R		10	
POS					
11	5102515 For/Front/Vorne Bøsning/Bushing/Buchsen	V/H - L/R		11	
12	5112303 V/H - L/R 205 mm. Stabilisatorstang/Stabilizer rod/Diagonalstrebe			12	

POS	Altea 2/04-			
Foraksel/Front axle/Vorneachse				
1	5014743 Venstre/Left/Links Bærearmlenke/Track control arm/Querlenker	(- Diesel) Nederste/Lower/Unten		
2	5014744 Højre/Right/Rechs Bærearmlenke/Track control arm/Querlenker	(- Diesel) Nederste/Lower/Unten		
3	5014745 Venstre/Left/Links Bærearmlenke/Track control arm/Querlenker	(Diesel) Nederste/Lower/Unten		
4	5014746 Højre/Right/Rechs Bærearmlenke/Track control arm/Querlenker	(Diesel) Nederste/Lower/Unten		
5	5034780 V/H - L/R Styrekugle/Tie rod end/Axialgelenk	810 mm. 16x1,5 RHT		
6	5034781 Venstre/Left/Links Styrekugle/Tie rod end/Kugelgelenk	16x1,5 RHT		
7	5034782 Højre/Right/Rechs Styrekugle/Tie rod end/Kugelgelenk	16x1,5 RHT		
8	5044743 Venstre/Left/Links Bærekugle/Ball joint/Radgelenk	Nederste/Lower/Unten		
9	5044744 Højre/Right/Rechs Bærekugle/Ball joint/Radgelenk	Nederste/Lower/Unten		
10	5104737 Bag/Rear/Hinten Bøsning/Bushing/Buchsen	Venstre/Left/Links Nederste/Lower/Unten		
POS				
11	5104738 Bag/Rear/Hinten Bøsning/Bushing/Buchsen	Højre/Right/Rechs Nederste/Lower/Unten		
12	5104739 For/Front/Vorne Bøsning/Bushing/Buchsen	V/H - L/R Nederste/Lower/Unten		

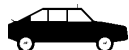

















POS	Arosa 5/97-			
Foraksel/Front axle/Vorneachse				
1	5004748 Venstre/Left/Links Styrestang/Steering rod/Spurstange	Konus/Cone 14mm.		1
2	5004749 Højre/Right/Rechs Styrestang/Steering rod/Spurstange	Konus/Cone 14mm.		2
3	5012343 V/H - L/R - 12/99 Bæream/Track control arm/Querlenker			3
4	5014737 V/H - L/R 1/00 - Bæream/Track control arm/Querlenker			4
5	5032358 V/H - L/R 14x1,5 RHT Styrekugle/Tie rod end/Axialgelenk	(*) Inderste/Inner		5
6	5034716 Højre/Right/Rechs (*) Styrekugle/Tie rod end/Kugelgelenk	14x1,5 RHT Yderste/Outer/Außen		6
7	5034735 Venstre/Left/Links (*) Styrekugle/Tie rod end/Kugelgelenk	14x1,5 RHT Yderste/Outer/Außen		7
8	5034759 Venstre/Left/Links (**) Styrekugle/Tie rod end/Kugelgelenk	14x1,5 RHT Yderste/Outer/Außen		8
9	5034760 Højre/Right/Rechs (**) Styrekugle/Tie rod end/Kugelgelenk	14x1,5 RHT Yderste/Outer/Außen		9
10	5034761 V/H - L/R 14x1,5 Styrekugle/Tie rod end/Axialgelenk	(**) Inderste/Inner		10
11	5044731 Venstre/Left/Links Bærekugle/Ball joint/Radgelenk	Nederste/Lower/Unten		11
POS				
12	5044732 Højre/Right/Rechs Bærekugle/Ball joint/Radgelenk	Nederste/Lower/Unten		12
13	5094707 (*) Manchetsæt/Boot kit/Manschetten satz			13
14	5094708 (**) Manchetsæt/Boot kit/Manschetten satz			14
15	5102314 Bag/Rear/Hinten Bøsning/Bushing/Buchsen	V/H - L/R		15
16	5102315 For/Front/Vorne Bøsning/Bushing/Buchsen	V/H - L/R		16
17	5112304 V/H - L/R Stabilisator/Stabilizer/Stabilisator	Ø15mm. 75 mm.		17
18	5112312 V/H - L/R Stabilisator bolt/Stabilizer bolt/Stabilisator bolzen	Ø18mm. 75 mm.		18
<p>(*) Uden servostyring Without Power Steering Ohne Servolenkung</p> <p>(**) Med servostyring With Power Steering Mit Servolenkung</p>				

POS	 Cordoba 11/93-10/02				
Foraksel/Front axle/Vorneachse					
1	Højre/Right/Rechs 14x1,5 RHT Styrekugle/Tie rod end/Kugelgelenk	- 9/95 Yderste/Outer/Außen		1	
2	5004711 Venstre/Left/Links (*) Styrestang/Steering rod/Spurstange			2	
3	5004712 Højre/Right/Rechs (*) Styrestang/Steering rod/Spurstange			3	
4	5004752 Venstre/Left/Links Styrestang/Steering rod/Spurstange	- 9/95 (**) 365 mm. RHT		4	
5	5004753 Højre/Right/Rechs Styrestang/Steering rod/Spurstange	- 9/95 (**) 365 mm. LHT		5	
6	5004779 Højre/Right/Rechs Styrestang/Steering rod/Spurstange	10/95 - (**)		6	
7	5004780 Venstre/Left/Links Styrestang/Steering rod/Spurstange	10/95 - (**)		7	
8	5012324 V/H - L/R Bæream/Track control arm/Querlenker			8	
9	5032348 V/H - L/R 14x1,5 RHT Styrekugle/Tie rod end/Axialgelenk	- 9/95 (**) Inderste/Inner		9	
10	5034716 Højre/Right/Rechs Styrekugle/Tie rod end/Kugelgelenk	14x1,5 RHT - 9/95 Yderste/Outer/Außen		10	
POS 					
11	5034717 V/H - L/R 22x1,5 RHT Styrekugle/Tie rod end/Axialgelenk	- 9/95 (*) Inderste/Inner		11	
12	5034735 Venstre/Left/Links Styrekugle/Tie rod end/Kugelgelenk	- 9/95 14x1,5 RHT Yderste/Outer/Außen		12	
13	5034763 Venstre/Left/Links Styrekugle/Tie rod end/Kugelgelenk	10/95 - 14x1,5 RHT Konus/Cone 14,0mm. Yderste/Outer/Außen		13	
14	5034764 Højre/Right/Rechs Styrekugle/Tie rod end/Kugelgelenk	10/95 - 14x1,5 RHT Konus/Cone 14,0mm. Yderste/Outer/Außen		14	
15	5034772 V/H - L/R Styrekugle/Tie rod end/Axialgelenk	10/95 - Inderste/Inner		15	
16	5044720 V/H - L/R Bærekugle/Ball joint/Radgelenk	Konus/Cone 19mm. Nederste/Lower/Unten		16	
17	5092313 ZF - 6/99 (**) Manchetsæt/Boot kit/Manschetten satz			17	
18	5094704 (*) Manchetsæt/Boot kit/Manschetten satz			18	
19	5094715 V/H - L/R TRW Manchetsæt/Boot kit/Manschetten satz	6/99- (**)		19	(*) Uden servostyring Without Power Steering Ohne Servolenkung
20	5104705 Bag/Rear/Hinten Bøsning/Bushing/Buchsen	V/H - L/R		20	(**) Med servostyring With Power Steering Mit Servolenkung



POS					
Foraksel/Front axle/Vorneachse					
21	5104720	For/Front/Vorne Bøsning/Bushing/Buchsen	V/H - L/R	 21	
22	5104799	Bag/Rear/Hinten Bøsning/Bushing/Buchsen	V/H - L/R	 22	
23	5112305	V/H - L/R Stabilisator/Stabilizer/Stabilisator	Ø17mm. 75 mm.		 23
POS  Cordoba 10/02-					
Foraksel/Front axle/Vorneachse					
1	5034307	Venstre/Left/Links Styrekugle/Tie rod end/Kugelgelenk	14X1,5 RHT Yderste/Outer/Außen	 1	
2	5034308	Højre/Right/Rechs Styrekugle/Tie rod end/Kugelgelenk	14X1,5 RHT Yderste/Outer/Außen		 2
3	5111510	V/H - L/R 270 mm. Stabilisator/Stabilizer/Stabilisator		 3	

POS	 Fura - Crono 1/82-12/86
Foraksel/Front axle/Vorneachse	
1	5012301 V/H - L/R Bæream/Track control arm/Querlenker  1
2	5032308 V/H - L/R 12x1,5 RHT Styrekugle/Tie rod end/Kugelgelenk Yderste/Outer/Außen  2
POS	 Ibiza 6/86-4/93
Foraksel/Front axle/Vorneachse	
1	5012309 V/H - L/R - 6/89 Bæream/Track control arm/Querlenker  1
2	5012323 V/H - L/R 7/89 - Bæream/Track control arm/Querlenker  2
3	5032303 V/H - L/R Styrekugle/Tie rod end/Kugelgelenk 12x1,5 RHT Yderste/Outer/Außen  3
4	5032347 V/H - L/R Styrekugle/Tie rod end/Axialgelenk 12x1,5 RHT Inderste/Inner  4
5	5092301 (*) Manchetsæt/Boot kit/Manschetten satz  5

POS	Ibiza 3/93-2/02			
		Foraksel/Front axle/Vorneachse		
1	5004711 Venstre/Left/Links (*) Styrestang/Steering rod/Spurstange			1
2	5004712 Højre/Right/Rechs (*) Styrestang/Steering rod/Spurstange			2
3	5004752 Venstre/Left/Links (**) Styrestang/Steering rod/Spurstange	- 9/95 365 mm. RHT		3
4	5004753 Højre/Right/Rechs (**) Styrestang/Steering rod/Spurstange	- 9/95 365 mm. LHT		4
5	5004779 Højre/Right/Rechs Styrestang/Steering rod/Spurstange	10/95 - (**)		5
6	5004780 Venstre/Left/Links Styrestang/Steering rod/Spurstange	10/95 - (**)		6
7	5012324 V/H - L/R Bærearml/Track control arm/Querlenker			7
8	5032348 V/H - L/R - 9/95 (**) Styrekugle/Tie rod end/Axialgelenk	14x1,5 RHT Inderste/Inner		8
9	5034716 Højre/Right/Rechs Styrekugle/Tie rod end/Kugelgelenk	- 9/95 14x1,5 RHT Yderste/Outer/Außen		9
10	5034717 V/H - L/R Styrekugle/Tie rod end/Axialgelenk	- 9/95 (*) 22x1,5 RHT Inderste/Inner		10
11	5034735 Venstre/Left/Links Styrekugle/Tie rod end/Kugelgelenk	- 9/95 14x1,5 RHT Yderste/Outer/Außen		11
POS				
12	5034763 Venstre/Left/Links Styrekugle/Tie rod end/Kugelgelenk	10/95 - 14x1,5 RHT Yderste/Outer/Außen		12
13	5034764 Højre/Right/Rechs Styrekugle/Tie rod end/Kugelgelenk	10/95 - 14x1,5 RHT Yderste/Outer/Außen		13
14	5034772 V/H - L/R Styrekugle/Tie rod end/Axialgelenk	10/95 - Inderste/Inner		14
15	5044720 V/H - L/R Bærekugle/Ball joint/Radgelenk	Konus/Cone 19mm. Nederste/Lower/Unten		15
16	5092313 ZF - 8/99 (**) Manchetsæt/Boot kit/Manschetten satz			16
17	5094704 (*) Manchetsæt/Boot kit/Manschetten satz			17
18	5094715 V/H - L/R TRW 8/99- (**) Manchetsæt/Boot kit/Manschetten satz			18
19	5104705 Bag/Rear/Hinten V/H - L/R Bøsning/Bushing/Buchsen			19
20	5104720 For/Front/Vorne V/H - L/R Bøsning/Bushing/Buchsen			20
21	5104799 Bag/Rear/Hinten V/H - L/R Bøsning/Bushing/Buchsen			21
22	5112305 V/H - L/R Ø17mm. 75 mm. Stabilisator/Stabilizer/Stabilisator			22
			(*) Uden servostyring Without Power Steering Ohne Servolenkung	
			(**) Med servostyring With Power Steering Mit Servolenkung	

POS	 Ibiza 2/02-			
		Foraksel/Front axle/Vorneachse		
1	5014302 V/H - L/R Bærearmlenke/Track control arm/Querlenker	Nederste/Lower/Unten		1
2	5034307 Venstre/Left/Links Styrekugle/Tie rod end/Kugelgelenk	14X1,5 RHT Yderste/Outer/Außen		2
3	5034308 Højre/Right/Rechs Styrekugle/Tie rod end/Kugelgelenk	14X1,5 RHT Yderste/Outer/Außen		3
4	5034309 V/H - L/R Styrekugle/Tie rod end/Axialgelenk	14X1,5 RHT Inderste/Inner		4
5	5044303 Venstre/Left/Links Bærekugle/Ball joint/Radgelenk	Nederste/Lower/Unten		5
6	5044304 Højre/Right/Rechs Bærekugle/Ball joint/Radgelenk	Nederste/Lower/Unten		6
7	5111510 V/H - L/R 270 mm. Stabilisator/Stabilizer/Stabilisator			7
		Foraksel/Front axle/Vorneachse		
1	5004779 Venstre/Left/Links Styrestang/Steering rod/Spurstange			1
2	5004780 Højre/Right/Rechs Styrestang/Steering rod/Spurstange			2
3	5014710 V/H - L/R Bærearmlenke/Track control arm/Querlenker	Nederste/Lower/Unten		3
4	5034763 Venstre/Left/Links Styrekugle/Tie rod end/Kugelgelenk	14x1,5 RHT Konus/Cone 14,0mm. Yderste/Outer/Außen		4
5	5034764 Højre/Right/Rechs Styrekugle/Tie rod end/Kugelgelenk	14x1,5 RHT Konus/Cone 14,0mm. Yderste/Outer/Außen		5
6	5034772 V/H - L/R Styrekugle/Tie rod end/Axialgelenk	Inderste/Inner		6
7	5044720 V/H - L/R Bærekugle/Ball joint/Radgelenk	Konus/Cone 19mm. Nederste/Lower/Unten		7
8	5104705 Bag/Rear/Hinten V/H - L/R Bøsning/Bushing/Buchsen			8
9	5104720 For/Front/Vorne V/H - L/R Bøsning/Bushing/Buchsen			9
10	5104799 Bag/Rear/Hinten V/H - L/R Bøsning/Bushing/Buchsen			10

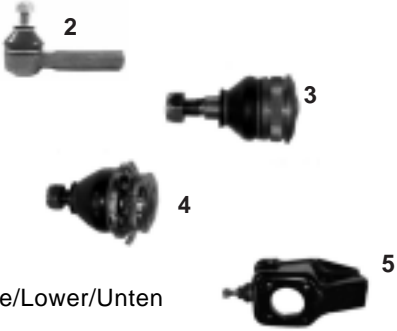
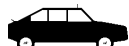
POS	Leon 11/99-				
		Foraksel/Front axle/Vorneachse			
1	5014717 Venstre/Left/Links Bærearmlenke/Track control arm/Querlenker				
2	5014718 Højre/Right/Rechs Bærearmlenke/Track control arm/Querlenker				
3	5034757 V/H - L/R Styrekugle/Tie rod end/Axialgelenk	14x1,5 RHT Inderste/Inner			
4	5034769 Højre/Right/Rechs Styrekugle/Tie rod end/Kugelgelenk	14x1,5 RHT Yderste/Outer/Außen			
5	5034770 Venstre/Left/Links Styrekugle/Tie rod end/Kugelgelenk	14x1,5 RHT Yderste/Outer/Außen			
6	5044738 Venstre/Left/Links Bærekugle/Ball joint/Radgelenk	Nederste/Lower/Unten			
7	5044739 Højre/Right/Rechs Bærekugle/Ball joint/Radgelenk	Nederste/Lower/Unten			
8	5094709 Manchetsæt/Boot kit/Manschetten satz				
9	5104708 Bag/Rear/Hinten Bøsning/Bushing/Buchsen	V/H - L/R			
10	5104720 For/Front/Vorne Bøsning/Bushing/Buchsen	V/H - L/R			
11	5114702 V/H - L/R Stabilisator arm/Stabilizer lever/Stabilisator hebel	Ø10mm. 103 mm. Kunststof/Synthetic/Kunststoff			
POS	Malaga 5/85-12/93				
		Foraksel/Front axle/Vorneachse			
1	5012309 V/H - L/R - 6/89 Bærearmlenke/Track control arm/Querlenker				
2	5012323 V/H - L/R 7/89 - Bærearmlenke/Track control arm/Querlenker				
3	5032303 V/H - L/R Styrekugle/Tie rod end/Kugelgelenk	12x1,5 RHT Yderste/Outer/Außen			
4	5032347 V/H - L/R Styrekugle/Tie rod end/Axialgelenk	12x1,5 RHT Inderste/Inner			
5	5092301 (*) Manchetsæt/Boot kit/Manschetten satz	Inderste/Inner			
					(*) Uden servostyring Without Power Steering Ohne Servolenkung

POS	 Marbella 1980-
Foraksel/Front axle/Vorneachse	
1	5012307 U V/H - L/R Bæream/Track control arm/Querlenker
2	5032318 V/H - L/R 10/82 - 12x1,5 RHT Styrekugle/Tie rod end/Kugelgelenk Yderste/Outer/Außen
3	5042303 V/H - L/R Bærekugle/Ball joint/Radgelenk Nederste/Lower/Unten
4	5042313 V/H - L/R Bærekugle/Ball joint/Radgelenk Nederste/Lower/Unten
5	5042314 V/H - L/R Bærekugle komplet/Complete ball joint/Radgelenk komplett Nederste/Lower/Unten
	
POS	 Terra 2/87-12/96
Foraksel/Front axle/Vorneachse	
1	5042303 V/H - L/R Bærekugle/Ball joint/Radgelenk Nederste/Lower/Unten
	

POS	Toledo 3/91-3/99				
Foraksel/Front axle/Vorneachse					
1	5004711 Venstre/Left/Links Styrestang/Steering rod/Spurstange	- 4/96 (*)			
2	5004712 Højre/Right/Rechs Styrestang/Steering rod/Spurstange	- 4/96 (*)			
3	5004752 Venstre/Left/Links Styrestang/Steering rod/Spurstange	- 4/96 (**)	365 mm. RHT		
4	5004753 Højre/Right/Rechs Styrestang/Steering rod/Spurstange	- 4/96 (**)	365 mm. LHT		
5	5004779 Venstre/Left/Links Styrestang/Steering rod/Spurstange	5/96 -			
6	5004780 Højre/Right/Rechs Styrestang/Steering rod/Spurstange	5/96 -			
8	5012324 V/H - L/R Bærearmlen/Track control arm/Querlenker				
9	5032348 V/H - L/R - 4/96 (**) Styrekugle/Tie rod end/Axialgelenk	14x1,5 RHT			
10	5034716 Højre/Right/Rechs Styrekugle/Tie rod end/Kugelgelenk	- 4/96 14x1,5 RHT			
11	5034717 V/H - L/R - 4/96 (*) Styrekugle/Tie rod end/Axialgelenk	22x1,5 RHT			
12	5034735 Venstre/Left/Links Styrekugle/Tie rod end/Kugelgelenk	- 4/96 14x1,5 RHT			
				(*) Uden servostyring Without Power Steering Ohne Servolenkung	
				(**) Med servostyring With Power Steering Mit Servolenkung	
POS					
13	5034763 Venstre/Left/Links 5/96 - Styrekugle/Tie rod end/Kugelgelenk	14x1,5 RHT	Konus/Cone 14,0mm.		
14	5034764 Højre/Right/Rechs 5/96 - Styrekugle/Tie rod end/Kugelgelenk	14x1,5 RHT	Konus/Cone 14,0mm.		
15	5034772 V/H - L/R Styrekugle/Tie rod end/Axialgelenk	5/96 -			
16	5044720 V/H - L/R Bærekugle/Ball joint/Radgelenk		Konus/Cone 19mm.		
17	5092313 ZF (**) Manchetsæt/Boot kit/Manschetten satz				
18	5094704 (*) Manchetsæt/Boot kit/Manschetten satz				
19	5104705 Bag/Rear/Hinten Bøsning/Bushing/Buchsen	V/H - L/R			
20	5104720 For/Front/Vorne Bøsning/Bushing/Buchsen	V/H - L/R			
21	5104799 Bag/Rear/Hinten Bøsning/Bushing/Buchsen	V/H - L/R			
22	5112304 V/H - L/R (1.6/2.0) 3/94 - Stabilisator/Stabilizer/Stabilisator	Ø15mm. 75 mm.			
23	5112305 V/H - L/R (-2.0 16V) - 3/94 Stabilisator/Stabilizer/Stabilisator	Ø17mm. 75 mm.			





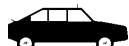



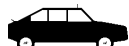





POS	Toledo 3/91-3/99			
		Foraksel/Front axle/Vorneachse		
24	5114702 V/H - L/R 10/98 - Ø10mm. 103 mm. Kunststoff/Synthetic/Kunststoff			24
		Stabilisator arm/Stabilizer lever/Stabilisator hebel		
		Bagaksel/Rear axle/Hinterachse		
25	5104724 V/H - L/R		25	
		Bøsningssæt/Bushing set/Buchsen satz		
POS	Toledo II 4/99-			
		Foraksel/Front axle/Vorneachse		
1	5014717 Venstre/Left/Links		1	
		Bærearml/Track control arm/Querlenker		
2	5014718 Højre/Right/Rechs		2	
		Bærearml/Track control arm/Querlenker		
3	5034757 V/H - L/R 14x1,5 RHT		3	
		Styrekugle/Tie rod end/Axialgelenk		
		Inderste/Inner		
4	5034769 Højre/Right/Rechs		4	
		Styrekugle/Tie rod end/Kugelgelenk		
		14x1,5 RHT		
		Yderste/Outer/Außen		
5	5034770 Venstre/Left/Links		5	
		Styrekugle/Tie rod end/Kugelgelenk		
		14x1,5 RHT		
		Yderste/Outer/Außen		
6	5044738 Venstre/Left/Links		6	
		Bærekugle/Ball joint/Radgelenk		
		Nederste/Lower/Unten		
7	5044739 Højre/Right/Rechs		7	
		Bærekugle/Ball joint/Radgelenk		
		Nederste/Lower/Unten		
8	5104708 Bag/Rear/Hinten V/H - L/R		8	
		Bøsning/Bushing/Buchsen		
9	5104720 For/Front/Vorne V/H - L/R		9	
		Bøsning/Bushing/Buchsen		
10	5114702 V/H - L/R Ø10mm. 103 mm. Kunststoff/Synthetic/Kunststoff			10
		Stabilisator arm/Stabilizer lever/Stabilisator hebel		

SEAT

POS	
POS	

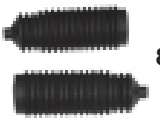









SEAT

POS	
POS	

POS	 100/110 1969-77 & 105/120 1977-12/90			
	Foraksel/Front axle/Vorneachse			
1	5034301 V/H - L/R Styrekugle/Tie rod end/Kugelgelenk	12x1 RHT Yderste/Outer/Außen		1
	Foraksel/Front axle/Vorneachse			
	POS	 130 3/85-10/91		
	Foraksel/Front axle/Vorneachse			
1	5034301 V/H - L/R Styrekugle/Tie rod end/Kugelgelenk	12x1 RHT Yderste/Outer/Außen		2
	Foraksel/Front axle/Vorneachse			
	POS	 Fabia 12/99-		
	Foraksel/Front axle/Vorneachse			
1	5014302 V/H - L/R Bærearmlenke/Track control arm/Querlenker	Nederste/Lower/Unten		1
2	5034307 Venstre/Left/Links Styrekugle/Tie rod end/Kugelgelenk	14X1,5 RHT Yderste/Outer/Außen		2
3	5034308 Højre/Right/Rechs Styrekugle/Tie rod end/Kugelgelenk	14X1,5 RHT Yderste/Outer/Außen		3
4	5034309 V/H - L/R CH. 6Y3736553- Styrekugle/Tie rod end/Axialgelenk	14X1,5 RHT Inderste/Inner		4
5	5044303 Venstre/Left/Links Bærekugle/Ball joint/Radgelenk	Nederste/Lower/Unten		5
6	5044304 Højre/Right/Rechs Bærekugle/Ball joint/Radgelenk	Nederste/Lower/Unten		6
7	5094301 Manchetsæt/Boot kit/Manschetten satz			8
8	5104301 For/Front/Vorne Bøsning/Bushing/Buchsen	V/H - L/R		8
9	5104302 Bag/Rear/Hinten Bøsning/Bushing/Buchsen	V/H - L/R		9
10	5111510 V/H - L/R 270 mm. Stabilisator/Stabilizer/Stabilisator			10

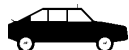

POS	Favorit 5/89-9/94 & Forman 1/94-6/95		
		Foraksel/Front axle/Vorneachse	
1	5014301 V/H - L/R Bærearmlenke/Track control arm/Querlenker	Nederste/Lower/Unten	
2	5014301 V/H - L/R - 11/93 Bærearmlenke/Track control arm/Querlenker		
3	5014303 Venstre/Left/Links Bærearmlenke/Track control arm/Querlenker	12/93 - Nederste/Lower/Unten	
4	5014304 Højre/Right/Rechs Bærearmlenke/Track control arm/Querlenker	12/93 - Nederste/Lower/Unten	
5	5034305 V/H - L/R 12x1 RHT Styreknude/Tie rod end/Kugelgelenk	Yderste/Outer/Außen	
6	5034306 V/H - L/R 12x1 RHT Styreknude/Tie rod end/Axialgelenk	Inderste/Inner	
7	5044301 V/H - L/R Bærekugle/Ball joint/Radgelenk	Nederste/Lower/Unten	
8	5094302 Manchetsæt/Boot kit/Manschetten satz		





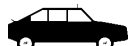

POS	Octavia (1U2 & 1U5) 9/96-			
Foraksel/Front axle/Vorneachse				
1	5004772 Venstre/Left/Links Styrestang/Steering rod/Spurstange	(-Wagon) CH. - 1UQ061000		1
2	5004773 Højre/Right/Rechs Styrestang/Steering rod/Spurstange	(-Wagon) CH. - 1UQ061000		2
3	5014717 Venstre/Left/Links Bæream/Track control arm/Querlenker			3
4	5014718 Højre/Right/Rechs Bæream/Track control arm/Querlenker			4
5	5034753 Venstre/Left/Links Styrekugle/Tie rod end/Kugelgelenk	CH. - 1UW061000 14x1,5 RHT Yderste/Outer/Außen		5
6	5034754 Højre/Right/Rechs Styrekugle/Tie rod end/Kugelgelenk	CH. - 1UW061000 14x1,5 RHT Yderste/Outer/Außen		6
7	5034757 V/H - L/R Styrekugle/Tie rod end/Axialgelenk	CH. 1UW061001- 14x1,5 RHT Inderste/Inner		7
8	5034769 Højre/Right/Rechs Styrekugle/Tie rod end/Kugelgelenk	CH. 1UW061001- 14x1,5 RHT Yderste/Outer/Außen		8
9	5034770 Venstre/Left/Links Styrekugle/Tie rod end/Kugelgelenk	CH. 1UW061001- 14x1,5 RHT Yderste/Outer/Außen		9
10	5044738 Venstre/Left/Links Bærekugle/Ball joint/Radgelenk	Nederste/Lower/Unten		10
11	5044739 Højre/Right/Rechs Bærekugle/Ball joint/Radgelenk	Nederste/Lower/Unten		11
POS				
12	5094709 Manchetsæt/Boot kit/Manschetten satz			
13	5104708 Bag/Rear/Hinten Bøsning/Bushing/Buchsen	V/H - L/R		13
14	5104720 For/Front/Vorne Bøsning/Bushing/Buchsen	V/H - L/R		14
15	5104736 Bag/Rear/Hinten (HD) Bøsning/Bushing/Buchsen	V/H - L/R		
16	5114702 V/H - L/R Ø10mm. 103 mm. Stabilisator arm/Stabilizer lever/Stabilisator hebel	Kunststof/Synthetic/Kunststoff		16







POS	 Octavia 6/04-		
Foraksel/Front axle/Vorneachse			
1	5014743 Venstre/Left/Links Bæream/Track control arm/Querlenker	(- Diesel) Nederste/Lower/Unten	
2	5014744 Højre/Right/Rechs Bæream/Track control arm/Querlenker	(- Diesel) Nederste/Lower/Unten	
3	5014745 Venstre/Left/Links Bæream/Track control arm/Querlenker	(Diesel) Nederste/Lower/Unten	
4	5014746 Højre/Right/Rechs Bæream/Track control arm/Querlenker	(Diesel) Nederste/Lower/Unten	
5	5034780 V/H - L/R 810 mm. 16x1,5 RHT Styrekugle/Tie rod end/Axialgelenk		
6	5034781 Venstre/Left/Links 16x1,5 RHT Styrekugle/Tie rod end/Kugelgelenk		
7	5034782 Højre/Right/Rechs 16x1,5 RHT Styrekugle/Tie rod end/Kugelgelenk		
8	5044743 Venstre/Left/Links Bærekugle/Ball joint/Radgelenk	Nederste/Lower/Unten	
9	5044744 Højre/Right/Rechs Bærekugle/Ball joint/Radgelenk	Nederste/Lower/Unten	
10	5104737 Bag/Rear/Hinten Bøsning/Bushing/Buchsen	Venstre/Left/Links Nederste/Lower/Unten	
POS			
11	5104738 Bag/Rear/Hinten Bøsning/Bushing/Buchsen	Højre/Right/Rechs Nederste/Lower/Unten	
12	5104739 For/Front/Vorne Bøsning/Bushing/Buchsen	V/H - L/R Nederste/Lower/Unten	





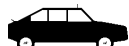

POS	Superb 2/02-		
Foraksel/Front axle/Vorneachse			
1	5014738 V/H - L/R CH. - 3U-3-021-397 Bæream/Track control arm/Querlenker		
2	5114717 Venstre/Left/Links 90 mm. Aluminium Stabilisatorstang/Stabilizer rod/Diagonalstrebe		
3	5114718 Højre/Right/Rechs 90 mm. Aluminium Stabilisatorstang/Stabilizer rod/Diagonalstrebe		
Foraksel/Front axle/Vorneachse			
1	5004774 V/H - L/R Styrestang/Steering rod/Spurstange		
2	5014719 Bag/Rear/Hinten Venstre/Left/Links Bæream/Track control arm/Querlenker Nederste/Lower/Unten		
3	5014720 Bag/Rear/Hinten Højre/Right/Rechs Bæream/Track control arm/Querlenker Nederste/Lower/Unten		
4	5014727 For/Front/Vorne Venstre/Left/Links Bæream/Track control arm/Querlenker Øverste/Upper/Oben		
5	5014728 For/Front/Vorne Højre/Right/Rechs Bæream/Track control arm/Querlenker Øverste/Upper/Oben		
6	5014733 Bag/Rear/Hinten Venstre/Left/Links CH. 3BVE083009/-3BVP102594- Bæream/Track control arm/Querlenker Øverste/Upper/Oben		
7	5014734 Bag/Rear/Hinten Højre/Right/Rechs CH. 3BVE083009/-3BVP102594- Bæream/Track control arm/Querlenker Øverste/Upper/Oben		
8	5014738 V/H - L/R CH. - 3B-3-072-000 Bæream sæt/Track control arm kit/Querlenker satz		
9	5014747 For/Front/Vorne V/H - L/R Bæream/Track control arm/Querlenker Nederste/Lower/Unten		







POS	
POS	





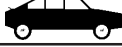

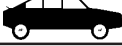
POS				
	Forester SF 8/97-			
1	5044401 V/H - L/R Bærekugle/Ball joint/Radgelenk	Yderste/Outer/Außen	 1	
	Impreza 8/92-			
	Foraksel/Front axle/Vorneachse			
1	5044401 V/H - L/R Bærekugle/Ball joint/Radgelenk	Nederste/Lower/Unten	 1	



POS	 Justy 11/84-10/95
Foraksel/Front axle/Vorneachse	
1	<p>5034401 V/H - L/R Styrekugle/Tie rod end/Kugelgelenk 14x1,5 RHT Yderste/Outer/Außen</p>  1
2	<p>5034402 V/H - L/R Styrekugle/Tie rod end/Axialgelenk 14x1,5 RHT Inderste/Inner</p>  2
3	<p>5044402 V/H - L/R Bærekugle/Ball joint/Radgelenk Nederste/Lower/Unten</p>  3
POS	 Legazy 1/89-11/98
Foraksel/Front axle/Vorneachse	
1	<p>5044401 V/H - L/R Bærekugle/Ball joint/Radgelenk Nederste/Lower/Unten</p>  1

POS	 Alto I & II & III & IV 6/82-				
Foraksel/Front axle/Vorneachse					
1	5015001 V/H - L/R Bæream/Track control arm/Querlenker				1
2	5035202 V/H - L/R Styrekugle/Tie rod end/Kugelgelenk	12x1,25 RHT Yderste/Outer/Außen			2
POS  Baleno 7/95-					
Foraksel/Front axle/Vorneachse					
1	5015203 Venstre/Left/Links Bæream/Track control arm/Querlenker		Nederste/Lower/Unten		
2	5015204 Højre/Right/Rechs Bæream/Track control arm/Querlenker		Nederste/Lower/Unten		
3	5035203 V/H - L/R Styrekugle/Tie rod end/Kugelgelenk	12x1,25 RHT Yderste/Outer/Außen			3
4	5115201 V/H - L/R Stabilisator bolt/Stabilizer bolt/Stabilisator bolzen	78 mm.			4
Bagaksel/Rear axle/Hinterachse					
5	5113613 Højre/Right/Rechs Stabilisatorstang/Stabilizer rod/Diagonalstrebe	150 mm.			5
6	5113614 Venstre/Left/Links Stabilisatorstang/Stabilizer rod/Diagonalstrebe	150 mm.			6







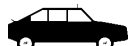

POS	 Liana 7/01-
	<p>Foraksel/Front axle/Vorneachse</p> <p>1 5115201 V/H - L/R 78 mm.  1 Stabilisator bolt/Stabilizer bolt/Stabilisator bolzen</p> <p>Bagaksel/Rear axle/Hinterachse</p> <p>2 5113613 Højre/Right/Rechs 150 mm.  2 Stabilisatorstang/Stabilizer rod/Diagonalstrebe</p> <p>3 5113614 Venstre/Left/Links 150 mm.  3 Stabilisatorstang/Stabilizer rod/Diagonalstrebe</p>
POS	 Samurai 11/88-
	<p>Foraksel/Front axle/Vorneachse</p> <p>1 5035201 V/H - L/R 16x1,5 RHT  1 Styrekugle/Tie rod end/Kugelgelenk Yderste/Outer/Außen</p>











POS	 Swift 10/84-
	Foraksel/Front axle/Vorneachse
1	5035203 V/H - L/R 12x1,25 RHT Styrekugle/Tie rod end/Kugelgelenk Yderste/Outer/Außen  1
2	5115201 V/H - L/R 78 mm. Stabilisator bolt/Stabilizer bolt/Stabilisator bolzen  2
POS	 Swift III (SG)
	Foraksel/Front axle/Vorneachse
1	5111901 V/H - L/R Stabilisatorstang/Stabilizer rod/Diagonalstrebe  1
POS	 Vitara 7/88-3/98
	Foraksel/Front axle/Vorneachse
1	5035201 V/H - L/R 16x1,5 RHT Styrekugle/Tie rod end/Kugelgelenk Yderste/Outer/Außen  1



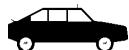

POS	 Grand Vitara 3/98-
Foraksel/Front axle/Vorneachse	
1	5113006 V/H - L/R 88 mm. Stabilisator bolt/Stabilizer bolt/Stabilisator bolzen
	 1
2	5113006 V/H - L/R 88 mm. Stabilisatorstang/Stabilizer rod/Diagonalstrebe
	 2
POS	 Wagon R+ 2/98-5/00
Foraksel/Front axle/Vorneachse	
1	5015201 V/H - L/R Bæream/Track control arm/Querlenker Nederste/Lower/Unten
2	5035203 V/H - L/R 12x1,25 RHT Styrekugle/Tie rod end/Kugelgelenk Yderste/Outer/Außen
	 2
3	5105201 V/H - L/R Bøsning/Bushing/Buchsen
	 3





POS	 Wagon R+ 5/00-
	<p>Foraksel/Front axle/Vorneachse</p> <p>1 5015201 V/H - L/R Bærearml/Track control arm/Querlenker Nederste/Lower/Unten</p> <p>2 5103613 V/H - L/R Bøsning/Bushing/Buchsen  2</p>
POS	



POS	
POS	











POS	 1100 1972-1/80			
Foraksel/Front axle/Vorneachse				
1	5031803 V/H - L/R Styrekugle/Tie rod end/Kugelgelenk	12x1,0 LHT Konus/Cone 11mm. Yderste/Outer/Außen		1
2	5041801 V/H - L/R Bærekugle/Ball joint/Radgelenk	Øverste/Upper/Oben		2
3	5041802 V/H - L/R Bærekugle/Ball joint/Radgelenk	Nederste/Lower/Unten		3
POS	 1307/1308/1309 1975-6/82 & 1510 1979-4/84 & Solara 1980-7/86			
Foraksel/Front axle/Vorneachse				
1	5031803 V/H - L/R Styrekugle/Tie rod end/Kugelgelenk	12x1,0 LHT Konus/Cone 11mm. Yderste/Outer/Außen		1
2	5041801 V/H - L/R Bærekugle/Ball joint/Radgelenk	Øverste/Upper/Oben		2
3	5041803 U V/H - L/R Bærekugle/Ball joint/Radgelenk	Nederste/Lower/Unten		3
4	5091803 U Manchetsæt/Boot kit/Manschetten satz			4



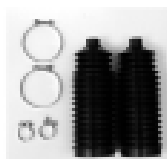



POS	 Horizon 11/77-6/86			
Foraksel/Front axle/Vorneachse				
1	5031803 V/H - L/R Styrekugle/Tie rod end/Kugelgelenk	12x1,0 LHT Konus/Cone 11mm. Yderste/Outer/Außen		1
2	5031807 U V/H - L/R Styrekugle/Tie rod end/Axialgelenk	12x1,0 LHT Inderste/Inner		2
3	5041801 V/H - L/R Bærekugle/Ball joint/Radgelenk	Øverste/Upper/Oben		3
4	5041802 V/H - L/R Bærekugle/Ball joint/Radgelenk	Nederste/Lower/Unten		4
5	5091803 U Manchetsæt/Boot kit/Manschetten satz			5
POS	 Samba 1982-6/86			
Foraksel/Front axle/Vorneachse				
1	5033702 V/H - L/R Styrekugle/Tie rod end/Kugelgelenk	14x1,5 RHT Yderste/Outer/Außen		1
2	5041901 V/H - L/R Bærekugle/Ball joint/Radgelenk	Nederste/Lower/Unten		2
3	5093703 (*) Manchetsæt/Boot kit/Manschetten satz			3

POS	 Tagora 2/81-12/87		
Foraksel/Front axle/Vorneachse			
1	5033702 V/H - L/R Styrekugle/Tie rod end/Kugelgelenk	14x1,5 RHT Yderste/Outer/Außen	 1
2	5043702 V/H - L/R Bærekugle/Ball joint/Radgelenk	Nederste/Lower/Unten	 2
POS			





POS				
1	5104501	Kryds t/ratstamme/Cross to steering column/Querverbindung zur Lenksäule		 1
POS		4 Runner (_N130)	10/93-	
	Foraksel/Front axle/Vorneachse			
1	5034526	V/H - L/R Styrekugle/Tie rod end/Kugelgelenk	17x1,5 Yderste/Outer/Außen	 1
2	5044533	V/H - L/R Bærekugle/Ball joint/Radgelenk	Øverste/Upper/Oben	 2
3	5044534	V/H - L/R Bærekugle/Ball joint/Radgelenk	Nederste/Lower/Unten	 3

POS	 Auris 10/06-
	<p>Foraksel/Front axle/Vorneachse</p> <p>1 xxxxxxx Venstre/Left/Links Bæream/Track control arm/Querlenker</p> <p>2 xxxxxxx Højre/Right/Rechs Bæream/Track control arm/Querlenker</p> <p>3 xxxxxxx Venstre/Left/Links Styrekugle/Tie rod end/Kugelgelenk</p> <p>4 xxxxxxx Højre/Right/Rechs Styrekugle/Tie rod end/Kugelgelenk</p> <p>5 xxxxxxx V/H - L/R Stabilisatorstang/Stabilizer rod/Diagonalstrebe</p>
POS	















POS	Avensis (T22_) 9/97-
Foraksel/Front axle/Vorneachse	
1	5034580 V/H - L/R 14x1,5 Styrekugle/Tie rod end/Axialgelenk Inderste/Inner  1
2	5034581 Venstre/Left/Links ZF 14x1,5 RHT Styrekugle/Tie rod end/Kugelgelenk Yderste/Outer/Außen  2
3	5034582 Højre/Right/Rechs ZF 14x1,5 RHT Styrekugle/Tie rod end/Kugelgelenk Yderste/Outer/Außen  3
4	5044528 V/H - L/R - 7/00 Bærekugle/Ball joint/Radgelenk Nederste/Lower/Unten  4
5	5093611 Saginaw Manchetsæt/Boot kit/Manschetten satz  5
6	5114510 Højre/Right/Rechs 70 mm. Stabilisatorstang/Stabilizer rod/Diagonalstrebe  6
7	5114511 Venstre/Left/Links 70 mm. Stabilisatorstang/Stabilizer rod/Diagonalstrebe  7
Bagaksel/Rear axle/Hinterachse	
8	5114514 V/H - L/R 140 mm. Stabilisatorstang/Stabilizer rod/Diagonalstrebe  8
POS	Avensis (T25) 4/03-
Foraksel/Front axle/Vorneachse	
1	5114515 V/H - L/R 285 mm. Stabilisatorstang/Stabilizer rod/Diagonalstrebe  1
Bagaksel/Rear axle/Hinterachse	
2	5114516 Venstre/Left/Links 100 mm. Stabilisatorstang/Stabilizer rod/Diagonalstrebe  2
3	5114517 Højre/Right/Rechs 100 mm. Stabilisatorstang/Stabilizer rod/Diagonalstrebe  3





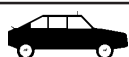





POS			
		Avensis Verso 8/01-	
		Foraksel/Front axle/Vorneachse	
1		5114518 V/H - L/R Stabilisatorstang/Stabilizer rod/Diagonalstrebe	280 mm.
			1
POS			
		Camry SV10/SV11/CV10 3/82-10/86	
		Foraksel/Front axle/Vorneachse	
1		5034521 U V/H - L/R Styrekugle/Tie rod end/Kugelgelenk	14x1,5 Yderste/Outer/Außen
2		5034553 U V/H - L/R Styrekugle/Tie rod end/Axialgelenk	14x1,5/14x1,5 Inderste/Inner
3		5044506 U V/H - L/R Bærekugle/Ball joint/Radgelenk	Nederste/Lower/Unten
4		5114503 U V/H - L/R Stabilisator bolt/Stabilizer bolt/Stabilisator bolzen	Ø10mm. 80 mm.
			1
			2
			3
			4

POS		
		Camry SV20/SV21/CV20 8/86-5/91
		Foraksel/Front axle/Vorneachse
1		5034535 V/H - L/R Styrekugle/Tie rod end/Kugelgelenk 14x1,5 RHT Yderste/Outer/Außen
2		5034554 U V/H - L/R Styrekugle/Tie rod end/Axialgelenk 14x1,5/14x1,5 Inderste/Inner
3		5044506 U V/H - L/R Bærekugle/Ball joint/Radgelenk Nederste/Lower/Unten
4		5114503 U V/H - L/R Stabilisator bolt/Stabilizer bolt/Stabilisator bolzen Ø10mm. 80 mm.
		Foraksel/Front axle/Vorneachse
		Camry SXV10/VCV10/SXV20/VCV20 6/91-11/01
		Foraksel/Front axle/Vorneachse
1		5034577 V/H - L/R Styrekugle/Tie rod end/Kugelgelenk 15x1,5 RHT Yderste/Outer/Außen
2		5114506 V/H - L/R (2.2/2.3) - 8/96 Stabilisatorstang/Stabilizer rod/Diagonalstrebe 70 mm.
3		5114508 Venstre/Left/Links Stabilisatorstang/Stabilizer rod/Diagonalstrebe (2.0) - 8/96 61 mm.
4		5114509 Højre/Right/Rechs Stabilisatorstang/Stabilizer rod/Diagonalstrebe (2.0) - 8/96 61 mm.
5		5114520 Venstre/Left/Links Stabilisatorstang/Stabilizer rod/Diagonalstrebe 8/96 -
6		5114521 Højre/Right/Rechs Stabilisatorstang/Stabilizer rod/Diagonalstrebe 8/96 -
		Bagaksel/Rear axle/Hinterachse
7		5114519 V/H - L/R - 8/96 Stabilisatorstang/Stabilizer rod/Diagonalstrebe
8		5114522 V/H - L/R 8/96 - Stabilisator/Stabilizer/Stabilisator







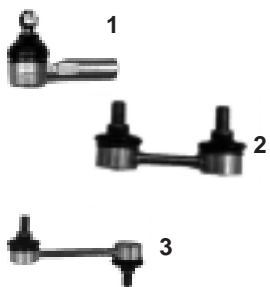
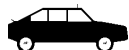
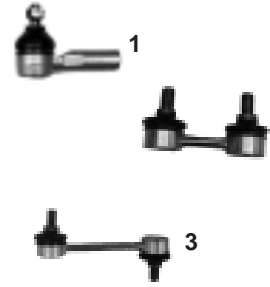

POS	 Camry_V30 11/01-
Foraksel/Front axle/Vorneachse	
1	<p>5114531 V/H - L/R 260 mm. Stabilisatorstang/Stabilizer rod/Diagonalstrebe</p>  1
POS	 Carina TA40/RA40 8/77-2/82
Foraksel/Front axle/Vorneachse	
1	<p>5034512 U V/H - L/R 14x1,5 Styrekugle/Tie rod end/Kugelgelenk Yderste/Outer/Außen</p>  1
2	<p>5044504 U V/H - L/R Bærekugle/Ball joint/Radgelenk Nederste/Lower/Unten</p>  2









POS	Carina AT151/ST150/ST151/CT150 10/83-5/88				
Foraksel/Front axle/Vorneachse					
1	5034520 V/H - L/R - 8/84 Styrekugle/Tie rod end/Kugelgelenk	12x1,25 Yderste/Outer/Außen		1	
2	5034535 V/H - L/R 9/84 - Styrekugle/Tie rod end/Kugelgelenk	14x1,5 RHT Yderste/Outer/Außen		2	
3	5034541 U V/H - L/R - 8/84 Styrekugle/Tie rod end/Axialgelenk	12x1,25/14x1,25 Inderste/Inner		3	
4	5034543 U V/H - L/R 9/84 - Styrekugle/Tie rod end/Axialgelenk	14x1,25/14x1,25 Inderste/Inner		4	
5	5044505 U V/H - L/R Bærekugle/Ball joint/Radgelenk	Nederste/Lower/Unten		5	
6	5094502 V/H - L/R (*) Manchetsæt/Boot kit/Manschetten satz			6	
7	5114502 U 140 mm. Stabilisator bolt/Stabilizer bolt/Stabilisator bolzen			7	
POS Carina II AT17# / ST17# / CT17# 12/87-6/93					
Foraksel/Front axle/Vorneachse					
1	5034560 U V/H - L/R Styrekugle/Tie rod end/Axialgelenk	15x1,5/14x1,5 Inderste/Inner		1	
2	5034561 U V/H - L/R (**) Styrekugle/Tie rod end/Axialgelenk	15x1,5/14x1,5 Inderste/Inner		2	
3	5034562 U Højre/Right/Rechs Styrekugle/Tie rod end/Kugelgelenk	15x1,5 Yderste/Outer/Außen		3	
4	5034563 U Venstre/Left/Links Styrekugle/Tie rod end/Kugelgelenk	15x1,5 Yderste/Outer/Außen		4	
5	5044527 V/H - L/R Bærekugle/Ball joint/Radgelenk	Nederste/Lower/Unten		5	
6	5094502 (*) Manchetsæt/Boot kit/Manschetten satz			6	
7	5114508 Venstre/Left/Links Stabilisatorstang/Stabilizer rod/Diagonalstrebe	61 mm.		7	
8	5114509 Højre/Right/Rechs Stabilisatorstang/Stabilizer rod/Diagonalstrebe	61 mm.		8	(*) Uden servostyring Without Power Steering Ohne Servolenkung
Bagaksel/Rear axle/Hinterachse					
9	5114512 V/H - L/R Stabilisatorstang/Stabilizer rod/Diagonalstrebe	140 mm.		9	(**) Med Servostyring With Power Steering Mit Servolenkung









POS	 Carina E AT19# / ST 19# / CT19# 2/92-9/97			
Foraksel/Front axle/Vorneachse				
1	5014509 Venstre/Left/Links Bærearmlenke/Track control arm/Querlenker	Nederste/Lower/Unten		
2	5014510 Højre/Right/Rechs Bærearmlenke/Track control arm/Querlenker	Nederste/Lower/Unten		
3	5034564 Højre/Right/Rechs Styrekugle/Tie rod end/Kugelgelenk	CH. JT...- - 10/95 15x1,5 Yderste/Outer/Außen		
4	5034565 Venstre/Left/Links Styrekugle/Tie rod end/Kugelgelenk	CH. JT...- - 10/95 15x1,5 Yderste/Outer/Außen		
5	5034567 V/H - L/R Styrekugle/Tie rod end/Axialgelenk	- 10/95 15x1,5 RHT Inderste/Inner		
6	5034581 Venstre/Left/Links Styrekugle/Tie rod end/Kugelgelenk	ZF (UK) 5/95 - 14x1,5 RHT Yderste/Outer/Außen		
7	5034582 Højre/Right/Rechs Styrekugle/Tie rod end/Kugelgelenk	ZF (UK) 5/95 - 14x1,5 RHT Yderste/Outer/Außen		
8	5034583 V/H - L/R Styrekugle/Tie rod end/Axialgelenk	ZF 5/95 - 14x1,5 RHT Inderste/Inner		
9	5044528 V/H - L/R Bærekugle/Ball joint/Radgelenk	Nederste/Lower/Unten		
10	5094503 Manchetsæt/Boot kit/Manschetten satz			
POS				
11	5114510 Højre/Right/Rechs Stabilisatorstang/Stabilizer rod/Diagonalstrebe	70 mm.		
12	5114511 Venstre/Left/Links Stabilisatorstang/Stabilizer rod/Diagonalstrebe	70 mm.		
Bagaksel/Rear axle/Hinterachse				
13	5114512 V/H - L/R Stabilisatorstang/Stabilizer rod/Diagonalstrebe	140 mm.		

POS	 Celica TA40/RA40 8/77-1981			
Foraksel/Front axle/Vorneachse				
1	5034512 U V/H - L/R Styrekugle/Tie rod end/Kugelgelenk	14x1,5 Yderste/Outer/Außen		1
2	5044504 U V/H - L/R Bærekugle/Ball joint/Radgelenk	Nederste/Lower/Unten		2
POS  Celica AT16# / ST16# 8/85-8/90				
Foraksel/Front axle/Vorneachse				
1	5034535 V/H - L/R Styrekugle/Tie rod end/Kugelgelenk	14x1,5 RHT Yderste/Outer/Außen		1
2	5034554 U V/H - L/R Styrekugle/Tie rod end/Axialgelenk	14x1,5/14x1,5 Inderste/Inner		2
3	5044527 V/H - L/R Bærekugle/Ball joint/Radgelenk	Nederste/Lower/Unten		3
4	5114506 V/H - L/R Stabilisatorstang/Stabilizer rod/Diagonalstrebe	70 mm.		4
5	5114509 V/H - L/R Stabilisatorstang/Stabilizer rod/Diagonalstrebe	61 mm.		5
Bagaksel/Rear axle/Hinterachse				
6	5114512 V/H - L/R Stabilisatorstang/Stabilizer rod/Diagonalstrebe	140 mm.		6

POS	 Celica AT 18# / ST18# 10/89-1/94
Foraksel/Front axle/Vorneachse	
1	5034535 V/H - L/R 14x1,5 RHT Styrekugle/Tie rod end/Kugelgelenk Yderste/Outer/Außen
2	5114506 V/H - L/R 70 mm. Stabilisatorstang/Stabilizer rod/Diagonalstrebe
Bagaksel/Rear axle/Hinterachse	
3	5114512 V/H - L/R 140 mm. Stabilisatorstang/Stabilizer rod/Diagonalstrebe
	
POS	 Celica AT 20# / ST20# 11/93-11/99
Foraksel/Front axle/Vorneachse	
1	5034535 V/H - L/R 14x1,5 RHT Styrekugle/Tie rod end/Kugelgelenk Yderste/Outer/Außen
2	5114507 V/H - L/R 61 mm. Stabilisatorstang/Stabilizer rod/Diagonalstrebe
Bagaksel/Rear axle/Hinterachse	
3	5114512 V/H - L/R 140 mm. Stabilisatorstang/Stabilizer rod/Diagonalstrebe
	











POS	 Celica ZZT23# 11/99-								
POS	 Corolla KE30/KE36 1975-2/80								
	<p>Foraksel/Front axle/Vorneachse</p> <table border="0"> <tr> <td data-bbox="145 1361 172 1391">1</td> <td data-bbox="199 1361 598 1417"> 5034512 U V/H - L/R Styrekugle/Tie rod end/Kugelgelenk </td> <td data-bbox="671 1361 906 1417"> 14x1,5 Yderste/Outer/Außen </td> <td data-bbox="1023 1326 1145 1402">  1 </td> </tr> <tr> <td data-bbox="145 1442 172 1471">2</td> <td data-bbox="199 1442 558 1498"> 5044504 U V/H - L/R Bærekugle/Ball joint/Radgelenk </td> <td data-bbox="671 1464 927 1494"> Nederste/Lower/Unten </td> <td data-bbox="1190 1424 1342 1500">  2 </td> </tr> </table>	1	5034512 U V/H - L/R Styrekugle/Tie rod end/Kugelgelenk	14x1,5 Yderste/Outer/Außen	 1	2	5044504 U V/H - L/R Bærekugle/Ball joint/Radgelenk	Nederste/Lower/Unten	 2
1	5034512 U V/H - L/R Styrekugle/Tie rod end/Kugelgelenk	14x1,5 Yderste/Outer/Außen	 1						
2	5044504 U V/H - L/R Bærekugle/Ball joint/Radgelenk	Nederste/Lower/Unten	 2						

POS	 Corolla KE70 3/79-4/83
Foraksel/Front axle/Vorneachse	
1	<p>5034501 U V/H - L/R 14x1,5  1</p> <p>Styrekugle/Tie rod end/Kugelgelenk Yderste/Outer/Außen</p>
2	<p>5034502 U V/H - L/R 14x1,5/14x1,5  2</p> <p>Styrekugle/Tie rod end/Axialgelenk Inderste/Inner</p>
3	<p>5044504 U V/H - L/R Nederste/Lower/Unten  3</p> <p>Bærekugle/Ball joint/Radgelenk</p>
4	<p>5114501 V/H - L/R 130 mm.  4</p> <p>Stabilisator bolt/Stabilizer bolt/Stabilisator bolzen</p>
POS	 Corolla 1300 TE AL20 1984-
Foraksel/Front axle/Vorneachse	
1	<p>5034508 U V/H - L/R 14x1,5/14x1,5  1</p> <p>Styrekugle/Tie rod end/Axialgelenk Inderste/Inner</p>
2	<p>5044502 V/H - L/R Nederste/Lower/Unten  2</p> <p>Bærekugle/Ball joint/Radgelenk</p>



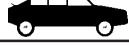



POS	Corolla CE70 Diesel 1982-87
Foraksel/Front axle/Vorneachse	
1	5034512 U V/H - L/R Styrekugle/Tie rod end/Kugelgelenk 14x1,5 Yderste/Outer/Außen  1
2	5044504 U V/H - L/R Bærekugle/Ball joint/Radgelenk Nederste/Lower/Unten  2
3	5114501 V/H - L/R Stabilisator bolt/Stabilizer bolt/Stabilisator bolzen 130 mm.  3
POS	Corolla AE80/AE81/AE82/EE80 Serie/CE80 Serie 5/83-8/84
Foraksel/Front axle/Vorneachse	
1	5034520 V/H - L/R Styrekugle/Tie rod end/Kugelgelenk 12x1,25 Yderste/Outer/Außen  1
2	5034541 U V/H - L/R Styrekugle/Tie rod end/Axialgelenk 12x1,25/14x1,25 Inderste/Inner  2
3	5044505 U V/H - L/R Bærekugle/Ball joint/Radgelenk Nederste/Lower/Unten  3
4	5094502 V/H - L/R Manchetsæt/Boot kit/Manschetten satz  4
5	5114501 V/H - L/R Stabilisator bolt/Stabilizer bolt/Stabilisator bolzen 130 mm.  5
Bagaksel/Rear axle/Hinterachse	
6	5114503 U V/H - L/R Stabilisator bolt/Stabilizer bolt/Stabilisator bolzen Ø10mm. 80 mm.  6

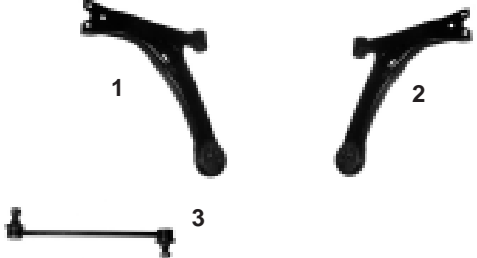
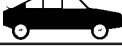
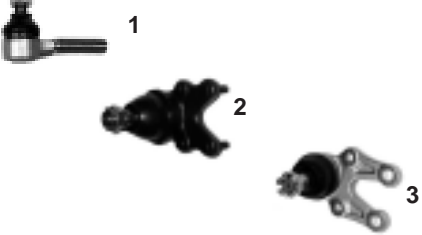











POS	Corolla AE80/AE81/AE82/EE80 Serie/CE80 Serie 9/84-5/88
Foraksel/Front axle/Vorneachse	
1	5044505 U V/H - L/R Bærekugle/Ball joint/Radgelenk Nederste/Lower/Unten
2	5094502 Manchetsæt/Boot kit/Manschetten satz
3	5114501 V/H - L/R 130 mm. Stabilisator bolt/Stabilizer bolt/Stabilisator bolzen
Bagaksel/Rear axle/Hinterachse	
4	5114503 U V/H - L/R Ø10mm. 80 mm. Stabilisator bolt/Stabilizer bolt/Stabilisator bolzen
5	5034535 V/H - L/R 14x1,5 RHT Styrekugle/Tie rod end/Kugelgelenk Yderste/Outer/Außen
6	5034543 U V/H - L/R 14x1,25/14x1,25 Styrekugle/Tie rod end/Axialgelenk Inderste/Inner
POS	Corolla AE86 (- GT) 5/83-1/88
Foraksel/Front axle/Vorneachse	
1	5034501 U V/H - L/R 14x1,5 Styrekugle/Tie rod end/Kugelgelenk Yderste/Outer/Außen
2	5034502 U V/H - L/R (*) 14x1,5/14x1,5 Styrekugle/Tie rod end/Axialgelenk Inderste/Inner
3	5044504 U V/H - L/R Bærekugle/Ball joint/Radgelenk Nederste/Lower/Unten
4	5114501 V/H - L/R 130 mm. Stabilisator bolt/Stabilizer bolt/Stabilisator bolzen
(*) Uden servostyring Without Power Steering Ohne Servolenkung	









POS	Corolla AE92/AE95/EE90/CE90 5/87-6/93				
Foraksel/Front axle/Vorneachse					
1	5014505 U Venstre/Left/Links Bærearmlenke/Track control arm/Querlenker	Nederste/Lower/Unten			
2	5014506 U Højre/Right/Rechs Bærearmlenke/Track control arm/Querlenker	Nederste/Lower/Unten			
3	5034535 V/H - L/R Styrekugle/Tie rod end/Kugelgelenk	14x1,5 RHT Yderste/Outer/Außen			
4	5034552 V/H - L/R (*) Styrekugle/Tie rod end/Axialgelenk	14x1,5/14x1,5 Inderste/Inner			
5	5034559 U V/H - L/R (**) Styrekugle/Tie rod end/Axialgelenk	14x1,5/14x1,5 Inderste/Inner			
6	5044525 Venstre/Left/Links Bærekugle/Ball joint/Radgelenk	Nederste/Lower/Unten			
7	5044526 Højre/Right/Rechs Bærekugle/Ball joint/Radgelenk	Nederste/Lower/Unten			
8	5094502 (*) Manchetsæt/Boot kit/Manschetten satz				
9	5114506 V/H - L/R Stabilisatorstang/Stabilizer rod/Diagonalstrebe	70 mm.			
Bagaksel/Rear axle/Hinterachse					
10	5114512 V/H - L/R Stabilisatorstang/Stabilizer rod/Diagonalstrebe	140 mm.			
					(*) Uden servostyring Without Power Steering Ohne Servolenkung
					(**) Med Servostyring With Power Steering Mit Servolenkung
POS	Corolla AE10# / EE10# / CE10# 5/92-4/97				
Foraksel/Front axle/Vorneachse					
1	5014507 Venstre/Left/Links Bærearmlenke/Track control arm/Querlenker	- 4/95 Nederste/Lower/Unten			
2	5014508 Højre/Right/Rechs Bærearmlenke/Track control arm/Querlenker	- 4/95 Nederste/Lower/Unten			
3	5014513 Venstre/Left/Links Bærearmlenke/Track control arm/Querlenker	5/95 - Nederste/Lower/Unten			
4	5014514 Højre/Right/Rechs Bærearmlenke/Track control arm/Querlenker	5/95 - Nederste/Lower/Unten			
5	5034535 V/H - L/R Styrekugle/Tie rod end/Kugelgelenk	14x1,5 RHT Yderste/Outer/Außen			
6	5034570 V/H - L/R (**) Styrekugle/Tie rod end/Axialgelenk	14x1,5 RHT Inderste/Inner			
7	5044528 V/H - L/R Bærekugle/Ball joint/Radgelenk	5/95 - Nederste/Lower/Unten			
8	5094504 (**) Manchetsæt/Boot kit/Manschetten satz				
9	5114507 V/H - L/R Stabilisatorstang/Stabilizer rod/Diagonalstrebe	61 mm.			
Bagaksel/Rear axle/Hinterachse					
10	5114512 V/H - L/R Stabilisatorstang/Stabilizer rod/Diagonalstrebe	140 mm.			
					(*) Uden servostyring Without Power Steering Ohne Servolenkung
					(**) Med Servostyring With Power Steering Mit Servolenkung







POS	 Corolla AE11# / EE11# / CE11# 4/97-1/02
Foraksel/Front axle/Vorneachse	
1	5014513 Venstre/Left/Links Bærearmlenke/Track control arm/Querlenker Nederste/Lower/Unten  1
2	5014514 Højre/Right/Rechs Bærearmlenke/Track control arm/Querlenker Nederste/Lower/Unten  2
3	5034535 V/H - L/R 14x1,5 RHT Styrekugle/Tie rod end/Kugelgelenk  3
4	5044536 V/H - L/R Bærekugle/Ball joint/Radgelenk Nederste/Lower/Unten  4
5	5094504 Manchetsæt/Boot kit/Manschetten satz
6	5114507 V/H - L/R 61 mm. Stabilisatorstang/Stabilizer rod/Diagonalstrebe  6
Bagaksel/Rear axle/Hinterachse	
7	5114523 V/H - L/R 65 mm. Stabilisatorstang/Stabilizer rod/Diagonalstrebe  7
POS	 Corolla _E12_ 1/02-
Foraksel/Front axle/Vorneachse	
1	5014515 Venstre/Left/Links Bærearmlenke/Track control arm/Querlenker Nederste/Lower/Unten  1
2	5014516 Højre/Right/Rechs Bærearmlenke/Track control arm/Querlenker Nederste/Lower/Unten  2
3	5114515 V/H - L/R 285 mm. Stabilisatorstang/Stabilizer rod/Diagonalstrebe  3
4	XXXXXXX For/Front/Vorne Bøsning/Bushing/Buchsen Nederste/Lower/Unten
5	XXXXXXX Bag/Rear/Hinten Bøsning/Bushing/Buchsen Nederste/Lower/Unten







POS	 Corolla Verso 1/02-
Foraksel/Front axle/Vorneachse	
1	5014515 Venstre/Left/Links Bærearmlenke/Track control arm/Querlenker Nederste/Lower/Unten
2	5014516 Højre/Right/Rechts Bærearmlenke/Track control arm/Querlenker Nederste/Lower/Unten
3	5114515 V/H - L/R Stabilisatorstang/Stabilizer rod/Diagonalstrebe 285 mm.
4	XXXXXXX For/Front/Vorne Bøsning/Bushing/Buchsen Nederste/Lower/Unten
5	XXXXXXX Bag/Rear/Hinten Bøsning/Bushing/Buchsen Nederste/Lower/Unten
	
POS	 Dyna 100 LH80 / YH81 8/85-
Foraksel/Front axle/Vorneachse	
1	5034526 V/H - L/R Styrekugle/Tie rod end/Kugelgelenk 17x1,5 Yderste/Outer/Außen
2	5044512 U V/H - L/R Bærekugle/Ball joint/Radgelenk Øverste/Upper/Oben
3	5044514 V/H - L/R Bærekugle/Ball joint/Radgelenk Nederste/Lower/Unten
	







POS	Hiace LH2#/LH3#/RH11/RH2#/RH3#RH4# 2/77-12/84
Foraksel/Front axle/Vorneachse	
1	<p>5114504 U V/H - L/R 190 mm.  1</p> <p>Stabilisator bolt/Stabilizer bolt/Stabilisator bolzen</p>
POS	Hiace LH5#/LH6#/LH7#/YH5#/YH6#/YH7# 12/82-11/89
Foraksel/Front axle/Vorneachse	
1	<p>5034526 V/H - L/R 17x1,5  1</p> <p>Styrekugle/Tie rod end/Kugelgelenk Yderste/Outer/Außen</p>
2	<p>5044512 U V/H - L/R (2WD)  2</p> <p>Bærekugle/Ball joint/Radgelenk Øverste/Upper/Oben</p>
3	<p>5044514 V/H - L/R (2WD)  3</p> <p>Bærekugle/Ball joint/Radgelenk Nederste/Lower/Unten</p>
4	<p>5114504 U V/H - L/R - 7/87 190 mm.  4</p> <p>Stabilisator bolt/Stabilizer bolt/Stabilisator bolzen</p>
5	<p>5114505 U 8/87 - 150 mm.  5</p> <p>Stabilisator bolt/Stabilizer bolt/Stabilisator bolzen</p>









POS	Hiace LH10# / LH11# / RZH10# / RZH11# 8/89-8/95
Foraksel/Front axle/Vorneachse	
1	<p>5034573 V/H - L/R Styrekugle/Tie rod end/Kugelgelenk 17x1,5 RHT Konus/Cone 14,5mm. Yderste/Outer/Außen</p> 
2	<p>5034574 V/H - L/R Styrekugle/Tie rod end/Axialgelenk (2WD) 17x1,5 RHT Inderste/Inner</p> 
3	<p>5044514 V/H - L/R Bærekugle/Ball joint/Radgelenk (2WD) Nederste/Lower/Unten</p> 
4	<p>5044531 V/H - L/R Bærekugle/Ball joint/Radgelenk (2WD) Øverste/Upper/Oben</p> 
5	<p>5114524 V/H - L/R Stabilisatorstang/Stabilizer rod/Diagonalstrebe</p> 
POS	Hiace_H12 8/95-
Foraksel/Front axle/Vorneachse	
1	<p>5034573 V/H - L/R Styrekugle/Tie rod end/Kugelgelenk 17x1,5 RHT Konus/Cone 14,5mm. Yderste/Outer/Außen</p> 
2	<p>5034574 V/H - L/R Styrekugle/Tie rod end/Axialgelenk 17x1,5 RHT Inderste/Inner</p> 
3	<p>5044514 V/H - L/R Bærekugle/Ball joint/Radgelenk (2WD) Nederste/Lower/Unten</p> 
4	<p>5114525 Venstre/Left/Links - 7/99 Stabilisator bolt/Stabilizer bolt/Stabilisator bolzen</p> 
5	<p>5114526 Højre/Right/Rechs - 7/99 Stabilisator bolt/Stabilizer bolt/Stabilisator bolzen</p> 
6	<p>5114527 Venstre/Left/Links 7/99 - Stabilisator bolt/Stabilizer bolt/Stabilisator bolzen</p> 
7	<p>5114528 Højre/Right/Rechs 7/99 - Stabilisator bolt/Stabilizer bolt/Stabilisator bolzen</p> 



POS		Hilux LN30/LN40/RN30/RN33/RN35/RN40/RN43/RN45	8/78-3/84
Foraksel/Front axle/Vorneachse			
1	5004502 V/H - L/R Styrestang/Steering rod/Spurstange		 1
2	5034526 V/H - L/R Styrekugle/Tie rod end/Kugelgelenk	17x1,5 Yderste/Outer/Außen	 2
POS		Hilux LN5#/YN5# 2WD	3/83-8/88
Foraksel/Front axle/Vorneachse			
1	5004502 V/H - L/R Styrestang/Steering rod/Spurstange		 1
2	5034526 V/H - L/R Styrekugle/Tie rod end/Kugelgelenk	17x1,5 Yderste/Outer/Außen	 2
3	5044518 V/H - L/R Bærekugle/Ball joint/Radgelenk	Øverste/Upper/Oben	 3
4	5044519 U V/H - L/R Bærekugle/Ball joint/Radgelenk	Nederste/Lower/Unten	 4







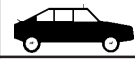

POS	 Hilux LN61/YN61 4WD 8/85-8/88
Foraksel/Front axle/Vorneachse	
1	<p>5034526 V/H - L/R Styrekugle/Tie rod end/Kugelgelenk 17x1,5 Yderste/Outer/Außen</p> 
2	<p>5044533 V/H - L/R Bærekugle/Ball joint/Radgelenk Øverste/Upper/Oben</p> 
POS	 Hilux LN8#/YN8#/LN9#/RN9# 8/88-
Foraksel/Front axle/Vorneachse	
1	<p>5034526 V/H - L/R Styrekugle/Tie rod end/Kugelgelenk 17x1,5 Yderste/Outer/Außen</p> 
2	<p>5044518 V/H - L/R Bærekugle/Ball joint/Radgelenk Øverste/Upper/Oben</p> 
3	<p>5044532 V/H - L/R Bærekugle/Ball joint/Radgelenk Nederste/Lower/Unten</p> 





POS	 Hilux LN11# / YN11# 8/88-			
	Foraksel/Front axle/Vorneachse			
1	5034526 V/H - L/R Styrekugle/Tie rod end/Kugelgelenk	17x1,5 Yderste/Outer/Außen		1
2	5044533 V/H - L/R Bærekugle/Ball joint/Radgelenk	Øverste/Upper/Oben		2
3	5044534 V/H - L/R Bærekugle/Ball joint/Radgelenk	4/89 - Nederste/Lower/Unten		3
POS	 Landcruiser J6 / J7 10/81-12/89 & Landcruiser BJ6#/FJ6#/HJ6# 10/81-12/89 & Landcruiser BJ7#/FJ7# 11/84-12/89			
	Foraksel/Front axle/Vorneachse			
1	5034578 Højre/Right/Rechs Styrekugle/Tie rod end/Kugelgelenk	21x1,5 Yderste/Outer/Außen		1







POS	 Landcruiser RJ70/LJ70/LJ71 11/84-12/89			
Foraksel/Front axle/Vorneachse				
1	5034557 U Højre/Right/Rechs Styrekugle/Tie rod end/Kugelgelenk	21x1,5 Yderste/Outer/Außen		1
2	5034578 Højre/Right/Rechs Styrekugle/Tie rod end/Kugelgelenk	21x1,5 Yderste/Outer/Außen		2
POS  Liteace YM2#/CM20 10/82-10/86				
Foraksel/Front axle/Vorneachse				
1	5034512 U V/H - L/R Styrekugle/Tie rod end/Kugelgelenk	14x1,5 Yderste/Outer/Außen		1
2	5044522 U V/H - L/R Bærekugle/Ball joint/Radgelenk	Øverste/Upper/Oben		2
3	5044523 U V/H - L/R Bærekugle/Ball joint/Radgelenk	Nederste/Lower/Unten		3









POS	 Liteace KM3#/CM3#/YM30 9/85-7/88
Foraksel/Front axle/Vorneachse	
1	<p>5034558 U V/H - L/R Styrekugle/Tie rod end/Axialgelenk 14x1,5/14x1,5 Inderste/Inner</p>  1
2	<p>5044522 U V/H - L/R Bærekugle/Ball joint/Radgelenk Øverste/Upper/Oben</p>  2
3	<p>5044523 U V/H - L/R Bærekugle/Ball joint/Radgelenk Nederste/Lower/Unten</p>  3
POS	 Liteace KM3# / CM3# / YM3# 8/88-1/92
Foraksel/Front axle/Vorneachse	
1	<p>5034575 U V/H - L/R Styrekugle/Tie rod end/Kugelgelenk 14x1,5 RHT Konus/Cone 12,8mm. Yderste/Outer/Außen</p>  1
2	<p>5034576 U V/H - L/R (*) Styrekugle/Tie rod end/Axialgelenk 14x1,5 RHT Inderste/Inner</p>  2
3	<p>5044522 U V/H - L/R Bærekugle/Ball joint/Radgelenk Øverste/Upper/Oben</p>  3
4	<p>5044523 U V/H - L/R Bærekugle/Ball joint/Radgelenk Nederste/Lower/Unten</p>  4





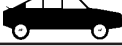

POS		Liteace CR2# / KR2# 1/92-1/95
POS		Model F Sports Van YR2# 8/85-7/88
Foraksel/Front axle/Vorneachse		
1	5034558 U V/H - L/R Styrekugle/Tie rod end/Axialgelenk	14x1,5/14x1,5 Inderste/Inner
2	5044522 U V/H - L/R Bærekugle/Ball joint/Radgelenk	Øverste/Upper/Oben
3	5044523 U V/H - L/R Bærekugle/Ball joint/Radgelenk	Nederste/Lower/Unten
		





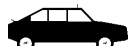

POS	 Model F Sports Van YR21 8/88-1/90			
Foraksel/Front axle/Vorneachse				
1	5034575 U V/H - L/R Styrekugle/Tie rod end/Kugelgelenk	14x1,5 RHT Konus/Cone 12,8mm. Yderste/Outer/Außen		1
2	5034576 U V/H - L/R (*) Styrekugle/Tie rod end/Axialgelenk	14x1,5 RHT Inderste/Inner		2
3	5044522 U V/H - L/R Bærekugle/Ball joint/Radgelenk	Øverste/Upper/Oben		3
4	5044523 U V/H - L/R Bærekugle/Ball joint/Radgelenk	Nederste/Lower/Unten		4
POS	 MR2 AW10/AW11 6/84-6/90			
Foraksel/Front axle/Vorneachse				
1	5034520 V/H - L/R Styrekugle/Tie rod end/Kugelgelenk	12x1,25 Yderste/Outer/Außen		1
2	5044502 V/H - L/R Bærekugle/Ball joint/Radgelenk	Nederste/Lower/Unten		2







POS	 MR2 SW20 12/89-5/00
Foraksel/Front axle/Vorneachse	
1	<p>5044502 V/H - L/R Bærekugle/Ball joint/Radgelenk Nederste/Lower/Unten</p>  1
POS	 MR2 ZZW30 5/00-
Foraksel/Front axle/Vorneachse	
1	<p>5034571 V/H - L/R Styrekugle/Tie rod end/Kugelgelenk 12x1,25 RHT Yderste/Outer/Außen</p>  1





POS	 Paseo 4/96-7/99			
Foraksel/Front axle/Vorneachse				
1	5034520 V/H - L/R Styrekugle/Tie rod end/Kugelgelenk	12x1,25 Yderste/Outer/Außen		1
POS  Picnic 5/96-				
Foraksel/Front axle/Vorneachse				
1	5034564 Højre/Right/Rechs Styrekugle/Tie rod end/Kugelgelenk	15x1,5 Yderste/Outer/Außen		1
2	5034565 Venstre/Left/Links Styrekugle/Tie rod end/Kugelgelenk	15x1,5 Yderste/Outer/Außen		
3	5114510 Venstre/Left/Links - 5/01 Stabilisatorstang/Stabilizer rod/Diagonalstrebe	70 mm.		3
4	5114511 Højre/Right/Rechs - 5/01 Stabilisatorstang/Stabilizer rod/Diagonalstrebe	70 mm.		4
5	5114518 V/H - L/R 5/01 - Stabilisatorstang/Stabilizer rod/Diagonalstrebe	280 mm.		5





POS	 Previa 5/90-8/00
Foraksel/Front axle/Vorneachse	
1	5034585 Venstre/Left/Links Styrekugle/Tie rod end/Kugelgelenk  1
2	5034586 Højre/Right/Rechs Styrekugle/Tie rod end/Kugelgelenk  2
3	5044537 V/H - L/R Bærekugle/Ball joint/Radgelenk Nederste/Lower/Unten  3
4	5114529 Venstre/Left/Links 250 mm. Stabilisatorstang/Stabilizer rod/Diagonalstrebe  4
5	5114530 Højre/Right/Rechs 250 mm. Stabilisatorstang/Stabilizer rod/Diagonalstrebe  5
POS	 Previa 8/00-
Foraksel/Front axle/Vorneachse	
1	5114531 V/H - L/R 260 mm. Stabilisatorstang/Stabilizer rod/Diagonalstrebe  1







POS	 Prius 5/00-1/04
Foraksel/Front axle/Vorneachse	
1	<p>5044536 V/H - L/R Bærekugle/Ball joint/Radgelenk Nederste/Lower/Unten</p>  1
POS	 Rav 4 SAX1_ 6/94-6/00
Foraksel/Front axle/Vorneachse	
1	<p>5034535 V/H - L/R Styrekugle/Tie rod end/Kugelgelenk Yderste/Outer/Außen</p>  1
2	<p>5044528 V/H - L/R Bærekugle/Ball joint/Radgelenk Nederste/Lower/Unten</p>  2
3	<p>5114507 V/H - L/R Stabilisatorstang/Stabilizer rod/Diagonalstrebe 61 mm.</p>  3









POS	 Rav 4 XA2 6/00-
Foraksel/Front axle/Vorneachse	
1	5044536 V/H - L/R Bærekugle/Ball joint/Radgelenk Nederste/Lower/Unten  1
2	5114532 V/H - L/R 285 mm. Stabilisatorstang/Stabilizer rod/Diagonalstrebe
Bagaksel/Rear axle/Hinterachse	
3	5114533 Venstre/Left/Links 100 mm. Stabilisatorstang/Stabilizer rod/Diagonalstrebe
4	5114534 Højre/Right/Rechs 100 mm. Stabilisatorstang/Stabilizer rod/Diagonalstrebe  4
POS	 SportsVan 5/96-01
Foraksel/Front axle/Vorneachse	
1	5114510 Højre/Right/Rechs 70 mm. Stabilisatorstang/Stabilizer rod/Diagonalstrebe  1
2	5114511 Venstre/Left/Links 70 mm. Stabilisatorstang/Stabilizer rod/Diagonalstrebe  2

POS	 SportsVan 01-
Foraksel/Front axle/Vorneachse	
1	<p>5114518 V/H - L/R 280 mm.  1</p> <p>Stabilisatorstang/Stabilizer rod/Diagonalstrebe</p>
POS	 Starlet KP60 Serie 2/78-9/84
Foraksel/Front axle/Vorneachse	
1	<p>5014502 U V/H - L/R 5/80-  1</p> <p>Bærearm/Track control arm/Querlenker</p>
2	<p>5034501 U V/H - L/R - 4/80 14x1,5  2</p> <p>Styrekugle/Tie rod end/Kugelgelenk Yderste/Outer/Außen</p>
3	<p>5034502 U V/H - L/R 14x1,5/14x1,5  3</p> <p>Styrekugle/Tie rod end/Axialgelenk Inderste/Inner</p>

POS	 Starlet EP7 Serie 10/84-12/89		
1	<p>Foraksel/Front axle/Vorneachse</p> <p>5044535 U V/H - L/R Bærekugle/Ball joint/Radgelenk Nederste/Lower/Unten</p>  1		
POS			
1	<p>Starlet EP8# / NP8# 12/89-3/96</p> <p>Foraksel/Front axle/Vorneachse</p> <p>5034571 V/H - L/R Styrekugle/Tie rod end/Kugelgelenk 12x1,25 RHT Yderste/Outer/Außen</p>  1		

POS	 Starlet _P9_ 4/96-3/99
Foraksel/Front axle/Vorneachse	
1	<p>5034571 V/H - L/R 12x1,25 RHT  1</p> <p>Styrekugle/Tie rod end/Kugelgelenk Yderste/Outer/Außen</p>
POS	 Tercel AL11 8/78-7/82
Foraksel/Front axle/Vorneachse	
1	<p>5034502 U V/H - L/R 14x1,5/14x1,5  1</p> <p>Styrekugle/Tie rod end/Axialgelenk Inderste/Inner</p>
2	<p>5044501 U V/H - L/R Nederste/Lower/Unten  2</p> <p>Bærekugle/Ball joint/Radgelenk</p>







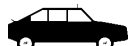



POS	 Tercel AL20 5/82-1/88
Foraksel/Front axle/Vorneachse	
1	<p>5034508 U V/H - L/R Styrekugle/Tie rod end/Axialgelenk 14x1,5/14x1,5 Inderste/Inner</p>  1
2	<p>5044502 V/H - L/R Bærekugle/Ball joint/Radgelenk Nederste/Lower/Unten</p>  2
POS	 Tercel AL25 10/82-1/88
Foraksel/Front axle/Vorneachse	
1	<p>5034508 U V/H - L/R Styrekugle/Tie rod end/Axialgelenk 14x1,5/14x1,5 Inderste/Inner</p>  1
2	<p>5044502 V/H - L/R Bærekugle/Ball joint/Radgelenk Nederste/Lower/Unten</p>  2







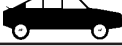





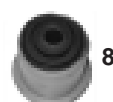

POS	 Yaris _CP10 / Yaris Verso NC/LP 4/99-
Foraksel/Front axle/Vorneachse	
1	5014511 Venstre/Left/Links Bærearmlenke/Track control arm/Querlenker Nederste/Lower/Unten
2	5014512 Højre/Right/Rechs Bærearmlenke/Track control arm/Querlenker Nederste/Lower/Unten
3	5034584 V/H - L/R Styrekugle/Tie rod end/Axialgelenk 12x1,25 RHT Nederste/Lower/Unten
4	5034587 Venstre/Left/Links Styrekugle/Tie rod end/Kugelgelenk 12x1,25 RHT Yderste/Outer/Außen
5	5034588 Højre/Right/Rechs Styrekugle/Tie rod end/Kugelgelenk 12x1,25 RHT Yderste/Outer/Außen
6	5044538 V/H - L/R Bærekugle/Ball joint/Radgelenk Nederste/Lower/Unten
7	5114535 V/H - L/R Stabilisator bolt/Stabilizer bolt/Stabilisator bolzen 100 mm.
	 1  2  3  4  5  6  7
POS	

TOYOTA

POS	
POS	

POS	Agila H00 9/00-				
Foraksel/Front axle/Vorneache					
1	5013619 V/H - L/R Bærearml/Track control arm/Querlenker	CH. - 1G075421 Nederste/Lower/Unten		1	
2	5013620 V/H - L/R Bærearml/Track control arm/Querlenker	CH. 1G075422- Nederste/Lower/Unten		2	
3	5033657 V/H - L/R 12x1,25 RHT Styrekugle/Tie rod end/Kugelgelenk	CH. - 1G075421 Yderste/Outer/Außen		3	
4	5033658 V/H - L/R 12x1,25 RHT Styrekugle/Tie rod end/Kugelgelenk	CH. 1G075422- Yderste/Outer/Außen		4	
5	5033659 V/H - L/R 12x1,25 RHT Styrekugle/Tie rod end/Axialgelenk	Inderste/Inner		5	
6	5103613 For/Front/Vorne Bøsning/Bushing/Buchsen	V/H - L/R		6	
7	5103614 Bag/Rear/Hinten Bøsning/Bushing/Buchsen	V/H - L/R		7	
Foraksel/Front axle/Vorneachse					
1	5003619 Venstre/Left/Links Styrestang/Steering rod/Spurstange			1	
2	5003620 Højre/Right/Rechs Styrestang/Steering rod/Spurstange			2	
3	5013607 Venstre/Left/Links Bærearml/Track control arm/Querlenker			3	
4	5013608 Højre/Right/Rechs Bærearml/Track control arm/Querlenker			4	
5	5033637 Venstre/Left/Links Styrekugle/Tie rod end/Kugelgelenk	16x2 RHT Yderste/Outer/Außen		5	
6	5033638 Højre/Right/Rechs Styrekugle/Tie rod end/Kugelgelenk	16x2 RHT Yderste/Outer/Außen		6	
7	5033639 16x2,0 Mellemlid/Intermediate link/Zwischenglied			7	
8	5043612 V/H - L/R Bærekugle/Ball joint/Radgelenk	Nederste/Lower/Unten		8	(*) Uden servostyring Without Power Steering Ohne Servolenkung
9	5093605 (*) Manchetsæt/Boot kit/Manschetten satz			9	
10	5093609 ZF (**) Manchetsæt/Boot kit/Manschetten satz			10	(**) Med servostyring With Power Steering Mit Servolenkung

POS	 Astra MK III 8/91-3/01 & Astravan MK III 1/91-8/98		
Foraksel/Front axle/Vorneachse			
11	5093614 Saginaw Manchetsæt/Boot kit/Manschetten satz		 11
12	5103601 For/Front/Vorne Indvendig/Inner/Innen 12 mm. Bøsning/Bushing/Buchsen	V/H - L/R (O.E.352 346)	 12
13	5103602 Bag/Rear/Hinten -7/93 CH. - R2587416/-R5111734/-R8145949 - Indvendig/Inner/Innen 16 mm. Bøsning/Bushing/Buchsen	V/H - L/R (O.E.352 348)	 13
14	5103603 Bag/Rear/Hinten 7/93 - CH. R2587417/-R5111735/-R8145950- Indvendig/Inner/Innen 16 mm. Bøsning/Bushing/Buchsen	V/H - L/R (O.E.352 356)	 14
15	5103699 Bag/Rear/Hinten Bøsning/Bushing/Buchsen	V/H - L/R	 15
16	5113605 V/H - L/R - 1/94 CH. - R2588487/-R5111734/-R8145949 Stabilisator/Stabilizer/Stabilisator	Ø22mm. 83 mm. (O.E.350 260)	 6
17	5113606 V/H - L/R - 1/94 CH. - R2595225/-R5111734/-R8145949 Stabilisator/Stabilizer/Stabilisator	Ø18mm. 83 mm. (O.E. 350 261)	 17
18	5113608 V/H - L/R 85 mm. CH. R2595226,R5111735,R8145950- Stabilisator bolt/Stabilizer bolt/Stabilisator bolzen	1/94 - (O.E. 350 263)	 18
POS			
Bagaksel/Rear axle/Hinterachse			
19	5103604 V/H - L/R Bøsning/Bushing/Buchsen	(- Cabrio & GSi) (O.E. 402 645)	 19

POS	Astra MK IV 2/98- & Astravan MK IV 2/98-
Foraksel/Front axle/Vorneachse	
1	5013615 Venstre/Left/Links Bærearmlenke/Track control arm/Querlenker 
2	5013616 Højre/Right/Rechs Bærearmlenke/Track control arm/Querlenker 
3	5033655 V/H - L/R Styrekugle/Tie rod end/Kugelgelenk 14x1,5 RHT Yderste/Outer/Außen 
4	5033660 V/H - L/R ZF Styrekugle/Tie rod end/Axialgelenk 14x1,5 Inderste/Inner 
5	5043627 V/H - L/R Bærekugle/Ball joint/Radgelenk Nederste/Lower/Unten 
6	5093613 Manchetsæt/Boot kit/Manschetten satz
7	5103611 For/Front/Vorne Bøsning/Bushing/Buchsen V/H - L/R 
8	5103612 Bag/Rear/Hinten Bøsning/Bushing/Buchsen V/H - L/R 
9	5113611 V/H - L/R 300 mm. Stabilisatorstang/Stabilizer rod/Diagonalstrebe 
POS	Astra MK V 3/04- & Meriva 5/03-
Foraksel/Front axle/Vorneachse	
1	5033660 V/H - L/R 14x1,5 Styrekugle/Tie rod end/Axialgelenk ZF Inderste/Inner 
2	5033671 Venstre/Left/Links Styrekugle/Tie rod end/Kugelgelenk ZF 14x1,5 RHT Yderste/Outer/Außen 
3	5033672 Højre/Right/Rechs Styrekugle/Tie rod end/Kugelgelenk ZF 14x1,5 RHT Yderste/Outer/Außen 
4	5043627 V/H - L/R Bærekugle/Ball joint/Radgelenk Nederste/Lower/Unten 
5	5113611 V/H - L/R 300 mm. Stabilisatorstang/Stabilizer rod/Diagonalstrebe (Interactive Drivning System) 
6	5113612 V/H - L/R 302 mm. Stabilisatorstang/Stabilizer rod/Diagonalstrebe (nteractive Drivning System) 









POS	Carlton MK II 1978-85			
Foraksel/Front axle/Vorneachse				
1	5003614 U Midt/Center/Mitte Styrestang/Steering rod/Spurstange			1
2	5033618 V/H - L/R 14x1,5 Styrekugle/Tie rod end/Kugelgelenk	Yderste/Outer/Außen		2
3	5033619 V/H - L/R 14x1,5 Styrekugle/Tie rod end/Kugelgelenk	Inderste/Inner		3
4	5043620 V/H - L/R Bærekugle/Ball joint/Radgelenk	Nederste/Lower/Unten		4
POS	Carlton MK III 8/86-3/94			
Foraksel/Front axle/Vorneachse				
1	5003617 Midt/Center/Mitte Styrestang/Steering rod/Spurstange	1.8/2.0/2.6/3.0 (**)		1
2	5003627 Venstre/Left/Links Styrestang/Steering rod/Spurstange			2
3	5003628 Højre/Right/Rechs Styrestang/Steering rod/Spurstange			3
4	5033640 Venstre/Left/Links Styrekugle/Tie rod end/Kugelgelenk	CH. H1169261- 14x1,5 RHT Yderste/Outer/Außen		4
5	5033641 Højre/Right/Rechs Styrekugle/Tie rod end/Kugelgelenk	CH. H1169261- 14x1,5 LHT Yderste/Outer/Außen		5
6	5033642 Venstre/Left/Links Styrekugle/Tie rod end/Kugelgelenk	CH. H1169261- 14x1,5 LHT Inderste/Inner		6
7	5033643 Højre/Right/Rechs Styrekugle/Tie rod end/Kugelgelenk	CH. H1169261- 14x1,5 RHT Inderste/Inner		7
8	5033648 U CH. H1169261- Mellemed/Intermediate link/Zwischenglied	14x1,5		8
9	5043625 Venstre/Left/Links Bærekugle/Ball joint/Radgelenk	Nederste/Lower/Unten		9
				(**) Med servostyring With Power Steering Mit Servolenkung











POS	Carlton MK III 8/86-3/94
Foraksel/Front axle/Vorneachse	
10	5043626 Højre/Right/Rechs Bærekugle/Ball joint/Radgelenk Nederste/Lower/Unten
11	5103606 For/Front/Vorne Bøsning/Bushing/Buchsen V/H - L/R
12	5103607 Bag/Rear/Hinten Bøsning/Bushing/Buchsen V/H - L/R
13	5113622 V/H - L/R Stabilisatorstang/Stabilizer rod/Diagonalstrebe
POS	Cavalier 1975-8/81
Foraksel/Front axle/Vorneachse	
1	5023607 U Tandstang/Steering rack/Zahnstange
2	5033603 V/H - L/R Styrekugle/Tie rod end/Kugelgelenk 14x1,5 Yderste/Outer/Außen
3	5043610 V/H - L/R Bærekugle/Ball joint/Radgelenk Øverste/Upper/Oben
4	5043611 V/H - L/R Bærekugle/Ball joint/Radgelenk Nederste/Lower/Unten
5	5093602 Manchetsæt/Boot kit/Manschetten satz











POS	Cavalier MK II 9/81-10/88
Foraksel/Front axle/Vorneachse	
1	5003626 Venstre/Left/Links Styrestang/Steering rod/Spurstange Inderste/Inner
2	5003629 Højre/Right/Rechs Styrestang/Steering rod/Spurstange
3	5033611 Venstre/Left/Links 16x1,5 RHT Styrekugle/Tie rod end/Kugelgelenk Yderste/Outer/Außen
4	5033612 Højre/Right/Rechs 16x1,5 RHT Styrekugle/Tie rod end/Kugelgelenk Yderste/Outer/Außen
5	5033622 V/H - L/R 16x1,5 Mellemlid/Intermediate link/Zwischenglied
6	5043612 V/H - L/R Bærekugle/Ball joint/Radgelenk Nederste/Lower/Unten
7	5093605 Manchetsæt/Boot kit/Manschetten satz
8	5113601 V/H - L/R 160 mm. Stabilisator bolt/Stabilizer bolt/Stabilisator bolzen
Bagaksel/Rear axle/Hinterachse	
9	5103604 V/H - L/R (O.E. 402 645) CH. J1189307-
Foraksel/Front axle/Vorneachse	
1	5003619 Venstre/Left/Links Styrestang/Steering rod/Spurstange
2	5003620 Højre/Right/Rechs Styrestang/Steering rod/Spurstange
3	5013607 Venstre/Left/Links Bærearmlenke/Track control arm/Querlenker
4	5013608 Højre/Right/Rechs Bærearmlenke/Track control arm/Querlenker
5	5033637 Venstre/Left/Links 16x2 RHT Styrekugle/Tie rod end/Kugelgelenk Yderste/Outer/Außen
6	5033638 Højre/Right/Rechs 16x2 RHT Styrekugle/Tie rod end/Kugelgelenk Yderste/Outer/Außen
7	5033639 16x2,0 Mellemlid/Intermediate link/Zwischenglied
8	5043612 V/H - L/R Bærekugle/Ball joint/Radgelenk Nederste/Lower/Unten
9	5093605 (*) Manchetsæt/Boot kit/Manschetten satz
10	5093609 ZF (**) Manchetsæt/Boot kit/Manschetten satz
11	5093610 Saginaw (**) Manchetsæt/Boot kit/Manschetten satz
	(*) Uden servostyring Without Power Steering Ohne Servolenkung
	(**) Med servostyring With Power Steering Mit Servolenkung









POS	Cavalier MK III 9/88-11/95			
Foraksel/Front axle/Vorneachse				
12	5103601 For/Front/Vorne V/H - L/R (O.E.352346) Indvendig/Inner/Innen12 mm. Bøsning/Bushing/Buchsen			
13	5103602 Bag/Rear/Hinten - 7/93 V/H - L/R (O.E.352348) Indvendig/Inner/Innen16 mm. Bøsning/Bushing/Buchsen			
14	5103603 Bag/Rear/Hinten 7/93 - V/H - L/R (O.E.352356) Indvendig/Inner/Innen16 mm. Bøsning/Bushing/Buchsen			
15	5103699 Bag/Rear/Hinten V/H - L/R Bøsning/Bushing/Buchsen			
16	5113605 V/H - L/R - 1994 Ø22mm. 83 mm. CH. - R1049313/-R5112256/-R7540515 Stabilisator/Stabilizer/Stabilisator			
17	5113606 V/H - L/R - 1994 Ø18mm. 83 mm. CH. - R1049313/-R5112256/-R7540515 Stabilisator/Stabilizer/Stabilisator			
18	5113608 V/H - L/R 1994 - (O.E.350263) 85 mm. CH. R5112257/-R7540516- Stabilisator bolt/Stabilizer bolt/Stabilisator bolzen			
POS	Chevette 1975-82			
Foraksel/Front axle/Vorneachse				
1	5023603 U Tandstang/Steering rack/Zahnstange			
2	5033603 V/H - L/R 14x1,5 Styrekugle/Tie rod end/Kugelgelenk	Yderste/Outer/Außen		
3	5033627 V/H - L/R 14x1,5/14x1,5 Styrekugle/Tie rod end/Axialgelenk	Inderste/Inner		
4	5043604 V/H - L/R Bærekugle/Ball joint/Radgelenk	Nederste/Lower/Unten		
5	5043605 V/H - L/R Bærekugle/Ball joint/Radgelenk	Øverste/Upper/Oben		
6	5093602 Manchetsæt/Boot kit/Manschetten satz			

POS	Combo (Corsa) 7/94-10/01				
Foraksel/Front axle/Vorneachse					
1	5013613 Venstre/Left/Links - 5/97 CH. - V3023597/-V4166925/-V6066279 Bærearml/Track control arm/Querlenker	Nederste/Lower/Unten		1	
2	5013614 Højre/Right/Rechs - 5/97 CH. - V3023597/-V4166925/-V6066279 Bærearml/Track control arm/Querlenker	Nederste/Lower/Unten		2	
3	5013621 Venstre/Left/Links CH. V3023598/-V4166926/-V6066280- Bærearml/Track control arm/Querlenker	5/97 - Nederste/Lower/Unten		3	
4	5013622 Højre/Right/Rechs CH. V3023598/-V4166926/-V6066280- Bærearml/Track control arm/Querlenker	5/97 - Nederste/Lower/Unten		4	
5	5033623 V/H - L/R 12x1,5 RHT CH. - V3023597/-V4166925/-V6066279 Styrekugle/Tie rod end/Kugelgelenk	- 5/97 Yderste/Outer/Außen		5	
6	5033644 V/H - L/R 12x1,5 RHT Styrekugle/Tie rod end/Axialgelenk	(*) Inderste/Inner		6	
7	5033645 V/H - L/R 12x1,5 RHT Styrekugle/Tie rod end/Axialgelenk	(**) Inderste/Inner		7	
8	5033656 V/H - L/R 12x1,5 CH. V3023598/-V4166926/-V6066280- Styrekugle/Tie rod end/Kugelgelenk	5/97 - Yderste/Outer/Außen		8	(*) Uden servostyring Without Power Steering Ohne Servolenkung
9	5043622 V/H - L/R Bærekugle/Ball joint/Radgelenk	- 5/97 Nederste/Lower/Unten		9	(**) Med servostyring With Power Steering Mit Servolenkung
10	5043629 V/H - L/R Bærekugle/Ball joint/Radgelenk	5/97 - Nederste/Lower/Unten		10	
POS					
11	5093608 (**) Manchetsæt/Boot kit/Manschetten satz			11	
12	5103605 V/H - L/R Bøsning/Bushing/Buchsen			12	













POS	Combo 10/01-			
		Foraksel/Front axle/Vorneachse		
1	5113609 V/H - L/R 244 mm. Stabilisatorstang/Stabilizer rod/Diagonalstrebe			1
POS	Corsa 3/93-9/00			
		Foraksel/Front axle/Vorneachse		
1	5013613 Venstre/Left/Links CH. - V3023597/-V4166925/-V6066279 Bærearmlenke/Track control arm/Querlenker	- 5/97		 1
			Nederste/Lower/Unten	
2	5013614 Højre/Right/Rechs CH. - V3023597/-V4166925/-V6066279 Bærearmlenke/Track control arm/Querlenker	- 5/97		 2
			Nederste/Lower/Unten	
3	5013621 Venstre/Left/Links CH. V3023598/-V4166926/-V6066280- Bærearmlenke/Track control arm/Querlenker	5/97 -		 3
			Nederste/Lower/Unten	
4	5013622 Højre/Right/Rechs CH. V3023598/-V4166926/-V6066280- Bærearmlenke/Track control arm/Querlenker	5/97 -		 4
			Nederste/Lower/Unten	
5	5033623 V/H - L/R 12x1,5 RHT CH. - V3023597/-V4166925/-V6066279 Styrekugle/Tie rod end/Kugelgelenk	- 5/97		 5
			Yderste/Outer/Außen	
6	5033644 V/H - L/R 12x1,5 RHT Styrekugle/Tie rod end/Axialgelenk	(*)	 6	
			Inderste/Inner	
7	5033645 V/H - L/R 12x1,5 RHT Styrekugle/Tie rod end/Axialgelenk	(**)	 7	(*) Uden servostyring Without Power Steering Ohne Servolenkung
			Inderste/Inner	
8	5033656 V/H - L/R 12x1,5 CH. V3023598/-V4166926/-V6066280- Styrekugle/Tie rod end/Kugelgelenk	5/97 -	 8	(**) Med servostyring With Power Steering Mit Servolenkung
			Yderste/Outer/Außen	















POS	Corsa 3/93-9/00				
		Foraksel/Front axle/Vorneachse			
9	5043622 V/H - L/R CH. - V3023597/-V4166925/-V6066279 Bærekugle/Ball joint/Radgelenk	- 5/97			9
10	5043629 V/H - L/R CH. V3023598/-V4166926/-V6066280- Bærekugle/Ball joint/Radgelenk	5/97 -	Nederste/Lower/Unten		10
11	5093608 (**) Manchetsæt/Boot kit/Manschetten satz				11
12	5103605 V/H - L/R Bøsning/Bushing/Buchsen				12
					(**) Med servostyring With Power Steering Mit Servolenkung
POS	Corsa MK II				
		Foraksel/Front axle/Vorneachse			
1	5013623 Venstre/Left/Links Bæream/Track control arm/Querlenker		Nederste/Lower/Unten		1
2	5013624 Højre/Right/Rechs Bæream/Track control arm/Querlenker		Nederste/Lower/Unten		2
3	5033623 V/H - L/R Styrekugle/Tie rod end/Kugelgelenk	12x1,5 RHT	Yderste/Outer/Außen		3
4	5033661 V/H - L/R Styrekugle/Tie rod end/Axialgelenk	12x1,5 RHT	Inderste/Inner		4
5	5043632 V/H - L/R Bærekugle/Ball joint/Radgelenk		Nederste/Lower/Unten		5
6	5113609 V/H - L/R 244 mm. Stabilisatorstang/Stabilizer rod/Diagonalstrebe				6







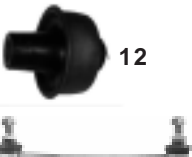



POS	 Frontera 3/92-10/98			
Foraksel/Front axle/Vorneachse				
1	5031410 V/H - L/R Styrekugle/Tie rod end/Kugelgelenk	14x1,5 LHT Konus/Cone 16mm. Inderste/Inner		
2	5031411 V/H - L/R Styrekugle/Tie rod end/Kugelgelenk	14x1,5 RHT Konus/Cone 16mm. Yderste/Outer/Außen		
3	5043630 V/H - L/R - 7/95 Bærekugle/Ball joint/Radgelenk	CH. - SV720102 Øverste/Upper/Oben		
4	5043631 V/H - L/R Bærekugle/Ball joint/Radgelenk	Nederste/Lower/Unten		
5	5043633 V/H - L/R 8/95 - Bærekugle/Ball joint/Radgelenk	CH. SV720103- Øverste/Upper/Oben		
6	5113613 Venstre/Left/Links Stabilisatorstang/Stabilizer rod/Diagonalstrebe	150 mm.		
7	5113614 Højre/Right/Rechs Stabilisatorstang/Stabilizer rod/Diagonalstrebe	150 mm.		
POS	 Frontera MK II 10/98-			
Foraksel/Front axle/Vorneachse				
1	5043631 V/H - L/R Bærekugle/Ball joint/Radgelenk	Nederste/Lower/Unten		
2	5043633 V/H - L/R Bærekugle/Ball joint/Radgelenk	Øverste/Upper/Oben		
3	5113613 Venstre/Left/Links Stabilisatorstang/Stabilizer rod/Diagonalstrebe	150 mm.		
4	5113614 Højre/Right/Rechs Stabilisatorstang/Stabilizer rod/Diagonalstrebe	150 mm.		

POS	 Meriva 5/03-
Foraksel/Front axle/Vorneachse	
1	5033665 V/H - L/R Styrekugle/Tie rod end/Kugelgelenk Yderste/Outer/Außen  1
2	5033666 V/H - L/R Styrekugle/Tie rod end/Axialgelenk Inderste/Inner  2
3	5113609 V/H - L/R 244 mm. Stabilisatorstang/Stabilizer rod/Diagonalstrebe  3
4	XXXXXXX Venstre/Left/Links Bærearmlenke/Track control arm/Querlenker Nederste/Lower/Unten
5	XXXXXXX Højre/Right/Rechs Bærearmlenke/Track control arm/Querlenker Nederste/Lower/Unten
POS	 Monterey 9/91-8/99
Foraksel/Front axle/Vorneachse	
1	5031410 V/H - L/R 14x1,5 LHT Konus/Cone 16mm. Styrekugle/Tie rod end/Kugelgelenk Inderste/Inner
2	5031411 V/H - L/R 14x1,5 RHT Konus/Cone 16mm. Styrekugle/Tie rod end/Kugelgelenk Yderste/Outer/Außen
3	5043620 V/H - L/R 7/98 - Bærekugle/Ball joint/Radgelenk Nederste/Lower/Unten  3
4	5043631 V/H - L/R - 7/98 Bærekugle/Ball joint/Radgelenk Nederste/Lower/Unten  4
5	5043633 V/H - L/R Bærekugle/Ball joint/Radgelenk Øverste/Upper/Oben  5

POS	Movano 7/98-			
Foraksel/Front axle/Vorneachse				
1	5013921 Venstre/Left/Links Bærearmlenke/Track control arm/Querlenker	Stål/Steel/Stahl Nederste/Lower/Unten		1
2	5013922 Højre/Right/Rechs Bærearmlenke/Track control arm/Querlenker	Stål/Steel/Stahl Nederste/Lower/Unten		
3	5033941 Venstre/Left/Links Styrekugle/Tie rod end/Kugelgelenk	16x1,5 RHT Yderste/Outer/Außen		3
4	5033942 Højre/Right/Rechs Styrekugle/Tie rod end/Kugelgelenk	16x1,5 RHT Yderste/Outer/Außen		4
5	5033943 V/H - L/R Styrekugle/Tie rod end/Axialgelenk	16x1,5 RHT Inderste/Inner		5
6	5043926 V/H - L/R Bærekugle/Ball joint/Radgelenk	Nederste/Lower/Unten		6
7	5043930 V/H - L/R Bærekugle/Ball joint/Radgelenk	Øverste/Upper/Oben		7
8	5113615 Venstre/Left/Links Stabilisatorstang/Stabilizer rod/Diagonalstrebe	127 mm.		8
9	5113616 Højre/Right/Rechs Stabilisatorstang/Stabilizer rod/Diagonalstrebe	127 mm.		9
POS	Omega B 3/94-			
Foraksel/Front axle/Vorneachse				
1	5003623 Midt/Center/Mitte Styrestang/Steering rod/Spurstange			1
2	5003624 Venstre/Left/Links Styrestang/Steering rod/Spurstange			2
3	5003625 Højre/Right/Rechs Styrestang/Steering rod/Spurstange			3
4	5013625 Venstre/Left/Links Bærearmlenke/Track control arm/Querlenker	Nederste/Lower/Unten		4
5	5013626 Højre/Right/Rechs Bærearmlenke/Track control arm/Querlenker	Nederste/Lower/Unten		5
6	5033650 Venstre/Left/Links Styrekugle/Tie rod end/Kugelgelenk	14x1,5 RHT Yderste/Outer/Außen		6
7	5033651 Højre/Right/Rechs Styrekugle/Tie rod end/Kugelgelenk	14x1,5 LHT Yderste/Outer/Außen		7
8	5033652 Venstre/Left/Links Styrekugle/Tie rod end/Axialgelenk	14x1,5 RHT Inderste/Inner		8
9	5033653 Højre/Right/Rechs Styrekugle/Tie rod end/Axialgelenk	14x1,5 LHT Inderste/Inner		9
10	5043627 V/H - L/R Bærekugle/Ball joint/Radgelenk	Nederste/Lower/Unten		10

POS	Omega B 3/94-
Foraksel/Front axle/Vorneachse	
11	5103615 For/Front/Vorne V/H - L/R  11 Bøsning/Bushing/Buchsen
12	5103616 Bag/Rear/Hinten V/H - L/R  12 Bøsning/Bushing/Buchsen
13	5113610 V/H - L/R 225 mm.  13 Stabilisatorstang/Stabilizer rod/Diagonalstrebe
Bagaksel/Rear axle/Hinterachse	
14	5113619 Venstre/Left/Links  14 Stabilisator/Stabilizer/Stabilisator
15	5113620 Højre/Right/Rechs  15 Stabilisator/Stabilizer/Stabilisator
POS	Senator 9/84-8/87
Foraksel/Front axle/Vorneachse	
1	5003614 U Midt/Center/Mitte  1 Styrestang/Steering rod/Spurstange
2	5033617  2 Mellemlid/Intermediate link/Zwischenglied
3	5033618 V/H - L/R 14x1,5  3 Styrekugle/Tie rod end/Kugelgelenk Yderste/Outer/Außen
4	5033619 V/H - L/R 14x1,5  4 Styrekugle/Tie rod end/Kugelgelenk Inderste/Inner
5	5043620 V/H - L/R  5 Bærekugle/Ball joint/Radgelenk Nederste/Lower/Unten
6	5113604 V/H - L/R 140 mm.  6 Stabilisator bolt/Stabilizer bolt/Stabilisator bolzen
7	5113607 V/H - L/R 195 mm.  7 Stabilisatorstang/Stabilizer rod/Diagonalstrebe

POS	 Senator MK II 9/87-9/93				
Foraksel/Front axle/Vorneachse					
1	5003617 Midt/Center/Mitte (**) Styrestang/Steering rod/Spurstange			 1	
2	5003627 Venstre/Left/Links Styrestang/Steering rod/Spurstange			 2	
3	5003628 Højre/Right/Rechs Styrestang/Steering rod/Spurstange			 3	
4	5033640 Venstre/Left/Links Styrekugle/Tie rod end/Kugelgelenk	CH. H1169261- 14x1,5 RHT Yderste/Outer/Außen		 4	
5	5033641 Højre/Right/Rechs Styrekugle/Tie rod end/Kugelgelenk	CH. H1169261- 14x1,5 LHT Yderste/Outer/Außen		 5	
6	5033642 Venstre/Left/Links Styrekugle/Tie rod end/Kugelgelenk	CH. H1169261- 14x1,5 LHT Inderste/Inner		 6	
7	5033643 Højre/Right/Rechs Styrekugle/Tie rod end/Kugelgelenk	CH. H1169261- 14x1,5 RHT Inderste/Inner		 7	
8	5033648 U V/H - L/R 14x1,5 Mellemed/Intermediate link/Zwischenglied	CH. H1169261-		 8	
9	5043625 Venstre/Left/Links Bærekugle/Ball joint/Radgelenk	Nederste/Lower/Unten		 9	
10	5043626 Højre/Right/Rechs Bærekugle/Ball joint/Radgelenk	Nederste/Lower/Unten		 10	
11	5103606 For/Front/Vorne Bøsning/Bushing/Buchsen	V/H - L/R		 11	(**) Med servostyring With Power Steering Mit Servolenkung
POS					
12	5103607 Bag/Rear/Hinten Bøsning/Bushing/Buchsen	V/H - L/R			
13	5113622 V/H - L/R Stabilisatorstang/Stabilizer rod/Diagonalstrebe			 12  13	









POS	Signum 5/03-
Foraksel/Front axle/Vorneachse	
1	<p>5113617 V/H - L/R 355 mm. Stabilisatorstang/Stabilizer rod/Diagonalstrebe</p>  1
Bagaksel/Rear axle/Hinterachse	
2	<p>5113618 V/H - L/R 86 mm. Stabilisatorstang/Stabilizer rod/Diagonalstrebe</p>  2
POS	Tigra 7/94-
Foraksel/Front axle/Vorneachse	
1	<p>5013613 Venstre/Left/Links - 6/97 CH. - V3023597/-V4166925/-V6066279 Bærearmlenke/Track control arm/Querlenker</p> <p>Nederste/Lower/Unten</p>  1
2	<p>5013614 Højre/Right/Rechts - 6/97 CH. - V3023597/-V4166925/-V6066279 Bærearmlenke/Track control arm/Querlenker</p> <p>Nederste/Lower/Unten</p>  2
3	<p>5013621 Venstre/Left/Links 7/97 - CH. V3023598/-V4166926/-V6066280- Bærearmlenke/Track control arm/Querlenker</p> <p>Nederste/Lower/Unten</p>  3
4	<p>5013622 Højre/Right/Rechts 7/97 - CH. V3023598/-V4166926/-V6066280- Bærearmlenke/Track control arm/Querlenker</p> <p>Nederste/Lower/Unten</p>  4
5	<p>5033623 V/H - L/R 12x1,5 RHT CH. - V3023597/-V4166925/-V6066279 Styrekugle/Tie rod end/Kugelgelenk</p> <p>Yderste/Outer/Außen</p>  5
6	<p>5033644 V/H - L/R 12x1,5 RHT Styrekugle/Tie rod end/Axialgelenk</p> <p>(*) Inderste/Inner</p>  6
7	<p>5033645 V/H - L/R 12x1,5 RHT Styrekugle/Tie rod end/Axialgelenk</p> <p>(**) Inderste/Inner</p>  7
8	<p>5033656 V/H - L/R 12x1,5 CH. V3023598/-V4166926/-V6066280- Styrekugle/Tie rod end/Kugelgelenk</p> <p>7/97 - Yderste/Outer/Außen</p>  8
<p>(*) Uden servostyring Without Power Steering Ohne Servolenkung</p> <p>(**) Med servostyring With Power Steering Mit Servolenkung</p>	



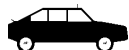







POS					
9	5043622 V/H - L/R - 6/97 CH. - V3023597/-V4166925/-V6066279 Bærekugle/Ball joint/Radgelenk	Nederste/Lower/Unten		9	
10	5043629 V/H - L/R 7/97 - CH. V3023598/-V4166926/-V6066280- Bærekugle/Ball joint/Radgelenk	Nederste/Lower/Unten		10	
11	5093608 (**) Manchetsæt/Boot kit/Manschetten satz			11	
12	5103605 V/H - L/R Bøsning/Bushing/Buchsen			12	

(**) Med servostyring
With Power Steering
Mit Servolenkung







POS		Vectra 10/95-			
Foraksel/Front axle/Vorneachse					
1	5013615 Venstre/Left/Links Bærearm/Track control arm/Querlenker			1	
2	5013616 Højre/Right/Rechts Bærearm/Track control arm/Querlenker			2	
3	5033646 V/H - L/R Styrekugle/Tie rod end/Kugelgelenk	14x1,5 RHT Yderste/Outer/Außen		3	
4	5033647 V/H - L/R Styrekugle/Tie rod end/Axialgelenk	ZF Inderste/Inner		4	
5	5033654 V/H - L/R Styrekugle/Tie rod end/Axialgelenk	Saginaw Inderste/Inner		5	
6	5043627 V/H - L/R Bærekugle/Ball joint/Radgelenk	Nederste/Lower/Unten		6	
7	5093611 Saginaw Manchetsæt/Boot kit/Manschetten satz			7	
8	5093612 ZF Manchetsæt/Boot kit/Manschetten satz			8	
9	5103611 For/Front/Vorne V/H - L/R Bøsning/Bushing/Buchsen			9	
10	5103612 Bag/Rear/Hinten V/H - L/R Bøsning/Bushing/Buchsen			10	

POS	Vectra 10/95-			
Foraksel/Front axle/Vorneachse				
11	5113609	V/H - L/R 244 mm.	(O.E.350 610)	11
		Stabilisatorstang/Stabilizer rod/Diagonalstrebe		
Bagaksel/Rear axle/Hinterachse				
12	5103610	V/H - L/R		12
		Bøsning/Bushing/Buchsen	Inderste/Inner	
13	5103617	V/H - L/R	4 Stk./Pcs/Stück	13
		Bærekugle/Ball joint/Radgelenk	Nederste/Lower/Unten	
14	5103618	V/H - L/R	4 Stk./Pcs/Stück	14
		Bøsning t/Stræberarm/Repair kit, radius link wheel suspension/Reparatursatz, Führungsstrebe		
15	5103619	For/Front/Vorne	V/H - L/R	15
		Bøsning/Bushing/Buchsen		
16	5103620	Bag/Rear/Hinten	V/H - L/R	16
		Bøsning/Bushing/Buchsen		
POS	Vectra MK II 10/03-			
Foraksel/Front axle/Vorneachse				
1	5013627	Venstre/Left/Links		1
		Bærearml/Track control arm/Querlenker	Nederste/Lower/Unten	
2	5013628	Højre/Right/Rechs		2
		Bærearml/Track control arm/Querlenker	Nederste/Lower/Unten	
3	5033667	Venstre/Left/Links	14x1,5 RHT	3
		Styrekugle/Tie rod end/Kugelgelenk	Yderste/Outer/Außen	
4	5033668	Højre/Right/Rechs	14x1,5 RHT	4
		Styrekugle/Tie rod end/Kugelgelenk	Yderste/Outer/Außen	
5	5033669	V/H - L/R 282,5 mm.	14x1,5	5
		Styrekugle/Tie rod end/Axialgelenk	Inderste/Inner	
6	5113617	V/H - L/R 355 mm.		6
		Stabilisatorstang/Stabilizer rod/Diagonalstrebe		
Bagaksel/Rear axle/Hinterachse				
7	5013629	V/H - L/R		7
		Bærearml/Track control arm/Querlenker	Øverste/Upper/Oben	
8	5103621	Bag/Rear/Hinten	V/H - L/R	8
		Bøsning/Bushing/Buchsen	Øverste/Upper/Oben	
9	5113618	V/H - L/R	86 mm.	9
		Stabilisatorstang/Stabilizer rod/Diagonalstrebe		







POS	 Viva HA/HB/HC 1963 / Firenza 1971-
Foraksel/Front axle/Vorneachse	
1	<p>5031201 V/H - L/R Styrekugle/Tie rod end/Kugelgelenk UNF 1/2" x 20,0 RHT Konus/Cone 11,5mm. Yderste/Outer/Außen</p> 
POS	 Vivaro 8/01-
Foraksel/Front axle/Vorneachse	
1	<p>5033662 V/H - L/R Styrekugle/Tie rod end/Axialgelenk Inderste/Inner</p>
2	<p>5033663 Venstre/Left/Links Styrekugle/Tie rod end/Kugelgelenk 12x1,5 Yderste/Outer/Außen</p> 
3	<p>5033664 Højre/Right/Rechs Styrekugle/Tie rod end/Kugelgelenk 12x1,5 Yderste/Outer/Außen</p> 
4	<p>5043634 V/H - L/R Bærekugle/Ball joint/Radgelenk Nederste/Lower/Unten</p> 
5	<p>5113621 V/H - L/R 280 mm. Stabilisatorstang/Stabilizer rod/Diagonalstrebe</p> 
6	<p>XXXXXXXX Venstre/Left/Links Bærearmlenke/Track control arm/Querlenker Nederste/Lower/Unten</p> 
7	<p>XXXXXXXX Højre/Right/Rechs Bærearmlenke/Track control arm/Querlenker Nederste/Lower/Unten</p> 

POS	 Zafira 4/99-		
		Foraksel/Front axle/Vorneachse	
1	5013615 Venstre/Left/Links Bærearmlenke/Track control arm/Querlenker		
2	5013616 Højre/Right/Rechs Bærearmlenke/Track control arm/Querlenker		
3	5033655 V/H - L/R Styrekugle/Tie rod end/Kugelgelenk	14x1,5 RHT Yderste/Outer/Außen	
4	5033660 V/H - L/R ZF Styrekugle/Tie rod end/Axialgelenk	14x1,5 Inderste/Inner	
5	5043627 V/H - L/R Bærekugle/Ball joint/Radgelenk	Nederste/Lower/Unten	
6	5093613 Manchetsæt/Boot kit/Manschetten satz		
7	5103611 For/Front/Vorne Bøsning/Bushing/Buchsen	V/H - L/R	
8	5103612 Bag/Rear/Hinten Bøsning/Bushing/Buchsen	V/H - L/R	
9	5113611 V/H - L/R 300 mm. Stabilisatorstang/Stabilizer rod/Diagonalstrebe		
POS			











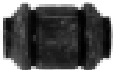

VOLKSWAGEN

POS	 1200/1300/1500 Type 1 8/65-4/68			
Foraksel/Front axle/Vorneachse				
1	5044701 V/H - L/R Bærekugle/Ball joint/Radgelenk	Øverste/Upper/Oben		1
2	5044702 V/H - L/R Bærekugle/Ball joint/Radgelenk	Nederste/Lower/Unten		2
POS	 1200/1300/1500 Type 1 5/68-			
Foraksel/Front axle/Vorneachse				
1	5034709 V/H - L/R 14x1,5 RHT Styrekugle/Tie rod end/Kugelgelenk	Konus/Cone 14,0mm. Yderste/Outer/Außen		1
2	5044701 V/H - L/R Bærekugle/Ball joint/Radgelenk	Øverste/Upper/Oben		2
3	5044702 V/H - L/R Bærekugle/Ball joint/Radgelenk	Nederste/Lower/Unten		3

VOLKSWAGEN







POS	 1302/1302 S Type 1 8/70-7/72
Foraksel/Front axle/Vorneachse	
1	5034709 V/H - L/R 14x1,5 RHT Styrekugle/Tie rod end/Kugelgelenk Konus/Cone 14,0mm. Yderste/Outer/Außen
2	5034710 U V/H - L/R 14x1,5 LHT Styrekugle/Tie rod end/Axialgelenk Konus/Cone 14,0mm. Inderste/Inner
3	5044703 U V/H - L/R Bærekugle/Ball joint/Radgelenk Nederste/Lower/Unten
	 1  3
POS	 1303/1303 S Type 1 8/72-1/80
Foraksel/Front axle/Vorneachse	
1	5034709 V/H - L/R Styrekugle/Tie rod end/Kugelgelenk 14x1,5 RHT Konus/Cone 14,0mm. Yderste/Outer/Außen
2	5034710 U V/H - L/R Styrekugle/Tie rod end/Axialgelenk 14x1,5 LHT Konus/Cone 14,0mm. Inderste/Inner
3	5044704 U V/H - L/R Bærekugle/Ball joint/Radgelenk Nederste/Lower/Unten
	 1  3









POS	1600 & Variant			
	Foraksel/Front axle/Vorneachse			
1	5034709 V/H - L/R Styrekugle/Tie rod end/Kugelgelenk	14x1,5 RHT Konus/Cone 14,0mm. Yderste/Outer/Außen		1
POS	Bora 10/98- & Bora Variant 5/99-			
	Foraksel/Front axle/Vorneachse			
1	5014717 Venstre/Left/Links Bæream/Track control arm/Querlenker			1
2	5014718 Højre/Right/Rechs Bæream/Track control arm/Querlenker			2
3	5034757 V/H - L/R Styrekugle/Tie rod end/Axialgelenk	14x1,5 RHT Inderste/Inner		3
4	5034769 Højre/Right/Rechs Styrekugle/Tie rod end/Kugelgelenk	14x1,5 RHT Yderste/Outer/Außen		4
5	5034770 Venstre/Left/Links Styrekugle/Tie rod end/Kugelgelenk	14x1,5 RHT Yderste/Outer/Außen		5
6	5044738 Venstre/Left/Links Bærekugle/Ball joint/Radgelenk	Nederste/Lower/Unten		6
7	5044739 Højre/Right/Rechs Bærekugle/Ball joint/Radgelenk	Nederste/Lower/Unten		7
8	5094709 Manchetsæt/Boot kit/Manschetten satz			
9	5104708 Bag/Rear/Hinten V/H - L/R Bøsning/Bushing/Buchsen			9
10	5104708 Bag/Rear/Hinten V/H - L/R Bøsning/Bushing/Buchsen			10

POS	Bora 10/98- & Bora Variant 5/99-
Foraksel/Front axle/Vorneachse	
11	5104720 For/Front/Vorne V/H - L/R Bøsning/Bushing/Buchsen  11
12	5104720 For/Front/Vorne V/H - L/R Bøsning/Bushing/Buchsen  12
13	5114702 V/H - L/R Ø10mm. 103 mm. Kunststoff/Synthetic/Kunststoff Stabilisator arm/Stabilizer lever/Stabilisator hebel  13
POS	Caddy I 8/82-7/92
Foraksel/Front axle/Vorneachse	
1	5004710 V/H - L/R (*) Styrestang/Steering rod/Spurstange  1
2	5014703 V/H - L/R Bærearmlenker/Track control arm/Querlenker  2
3	5024702 U Tandstang/Steering rack/Zahnstange
4	5034714 V/H - L/R Styrekugle/Tie rod end/Kugelgelenk 14x1,5 RHT Yderste/Outer/Außen  4
5	5034715 V/H - L/R (*) Styrekugle/Tie rod end/Axialgelenk 14x1,5 RHT Inderste/Inner  5
6	5044709 V/H - L/R Bærekugle/Ball joint/Radgelenk CH. - 178 3173 583 Konus/Cone 15mm. Nederste/Lower/Unten  6
7	5044708 V/H - L/R Bærekugle/Ball joint/Radgelenk CH. 178 3173 584- Konus/Cone 17mm. Nederste/Lower/Unten  7
8	5094703 (*) Manchetsæt/Boot kit/Manschetten satz  8
9	5104734 Bag/Rear/Hinten V/H - L/R Bøsning/Bushing/Buchsen  9
10	5104735 For/Front/Vorne V/H - L/R Bøsning/Bushing/Buchsen  10
(*) Uden servostyring Without Power Steering Ohne Servolenkung	

POS	Caddy II 11/95-			
Foraksel/Front axle/Vorneachse				
1	5004779 Venstre/Left/Links Styrestang/Steering rod/Spurstange		1	
2	5004780 Højre/Right/Rechs Styrestang/Steering rod/Spurstange		2	
3	5014710 V/H - L/R Bærearmlenke/Track control arm/Querlenker		3	
4	5034763 Venstre/Left/Links Styrekugle/Tie rod end/Kugelgelenk			
5	5034764 Højre/Right/Rechs Styrekugle/Tie rod end/Kugelgelenk			
6	5044720 Højre/Right/Rechs Bærekugle/Ball joint/Radgelenk			
7	5094707 (*) Manchetsæt/Boot kit/Manschetten satz		7	
8	5094708 (**) Manchetsæt/Boot kit/Manschetten satz		8	
9	5104705 Bag/Rear/Hinten V/H - L/R Bøsning/Bushing/Buchsen			
10	5104720 Bag/Rear/Hinten V/H - L/R Bøsning/Bushing/Buchsen		10	
11	5104799 Bag/Rear/Hinten V/H - L/R Bøsning/Bushing/Buchsen		11	
12	5112305 V/H - L/R Ø17mm. 75 mm. Stabilisator/Stabilizer/Stabilisator		12	
				(*) Uden servostyring Without Power Steering Ohne Servolenkung
				(**) Med servostyring With Power Steering Mit Servolenkung
POS	Caddy III 3/04-			
Foraksel/Front axle/Vorneachse				
1	5014743 Venstre/Left/Links Bærearmlenke/Track control arm/Querlenker			
2	5014744 Højre/Right/Rechs Bærearmlenke/Track control arm/Querlenker			
3	5014745 Venstre/Left/Links Bærearmlenke/Track control arm/Querlenker			
4	5014746 Højre/Right/Rechs Bærearmlenke/Track control arm/Querlenker			
5	5034780 V/H - L/R Styrekugle/Tie rod end/Axialgelenk			
6	5034781 Venstre/Left/Links Styrekugle/Tie rod end/Kugelgelenk			
7	5034782 Højre/Right/Rechs Styrekugle/Tie rod end/Kugelgelenk			
8	5044743 Venstre/Left/Links Bærekugle/Ball joint/Radgelenk			
9	5044744 Højre/Right/Rechs Bærekugle/Ball joint/Radgelenk			
10	5104737 Bag/Rear/Hinten Bøsning/Bushing/Buchsen			

POS	Caddy III 3/04-			
Foraksel/Front axle/Vorneachse				
11	5104738 Bag/Rear/Hinten Bøsning/Bushing/Buchsen	Højre/Right/Rechs Nederste/Lower/Unten		11
12	5104739 For/Front/Vorne Bøsning/Bushing/Buchsen	V/H - L/R Nederste/Lower/Unten		12
13	5114723 V/H - L/R 335 mm. Stabilisatorstang/Stabilizer rod/Diagonalstrebe			13
Bagaksel/Rear axle/Hinterachse				
14	5114724 V/H - L/R Stabilisatorstang/Stabilizer rod/Diagonalstrebe			14
POS	Corrado (53I) 9/88-12/95			
Foraksel/Front axle/Vorneachse				
1	5004752 Venstre/Left/Links Styrestang/Steering rod/Spurstange	(-VR6) 365 mm. RHT		1
2	5004753 Højre/Right/Rechs Styrestang/Steering rod/Spurstange	(-VR6) 365 mm. LHT		2
3	5004754 Venstre/Left/Links Styrestang/Steering rod/Spurstange	ZF (VR6) RHT		3
4	5004755 Højre/Right/Rechs Styrestang/Steering rod/Spurstange	ZF (VR6) LHT		4
5	5004756 Venstre/Left/Links Styrestang/Steering rod/Spurstange	TRW (VR6) 400 mm. RHT		5
6	5004757 Højre/Right/Rechs Styrestang/Steering rod/Spurstange	TRW (VR6) 400 mm. LHT		6
7	5014710 V/H - L/R Bærearmlen/Track control arm/Querlenker			7
8	5034716 Højre/Right/Rechs Styrekugle/Tie rod end/Kugelgelenk	14x1,5 RHT Yderste/Outer/Außen		8
9	5034735 Venstre/Left/Links Styrekugle/Tie rod end/Kugelgelenk	14x1,5 RHT Yderste/Outer/Außen		9
10	5044720 V/H - L/R Bærekugle/Ball joint/Radgelenk	Konus/Cone 19mm. Nederste/Lower/Unten		10













































POS	 Corrado (53I) 9/88-12/95
Foraksel/Front axle/Vorneachse	
12	<p>5092313 ZF Manchetsæt/Boot kit/Manschetten satz</p>  12
13	<p>5104705 Bag/Rear/Hinten V/H - L/R Bøsning/Bushing/Buchsen</p>  13
14	<p>5104799 Bag/Rear/Hinten V/H - L/R Bøsning/Bushing/Buchsen</p>  14
15	<p>5114725 V/H - L/R Stabilisator bolt/Stabilizer bolt/Stabilisator bolzen</p>  15
Bagaksel/Rear axle/Hinterachse	
16	<p>5104724 V/H - L/R (-VR6) Bøsningssæt/Bushing set/Buchsen satz</p>  16
POS	 Crafter (2E) 4/06-
Foraksel/Front axle/Vorneachse	
1	<p>xxxxxxx V/H - L/R Styrekugle/Tie rod end/Kugelgelenk</p>















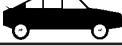

POS		
POS	 Derby (86) 2/77-9/81	
	Foraksel/Front axle/Vorneachse	
1	5004706 U Venstre/Left/Links Styrestang/Steering rod/Spurstange	CH. 8662300001 - CH. 86/87C200000  1
2	5014701 V/H - L/R Ø17mm. Bæream/Track control arm/Querlenker	CH. 869 2523 523-  2
3	5014702 U V/H - L/R Ø14mm. Bæream/Track control arm/Querlenker	CH. - 869 2523 522  3
4	5024701 Tandstang/Steering rack/Zahnstange	 4
5	5034712 Højre/Right/Rechs Styrekugle/Tie rod end/Kugelgelenk	14x1,5 RHT Yderste/Outer/Außen  5
6	5094701 9/79 - Manchetsæt/Boot kit/Manschetten satz	 6
7	5104722 Bøsning/Bushing/Buchsen	 7

POS	Derby (86C) 8/81-12/84			
Foraksel/Front axle/Vorneachse				
1	5004708 Venstre/Left/Links Styrestang/Steering rod/Spurstange	CH. 86/87D000001 - CH. 80RY150000		1
2	5004709 Højre/Right/Rechs Styrestang/Steering rod/Spurstange	CH. 86/87D000001 - CH. 80RY150000		2
3	5014701 V/H - L/R Ø17mm. Bærearmlenke/Track control arm/Querlenker			3
4	5024701 Tandstang/Steering rack/Zahnstange			4
5	5034712 Højre/Right/Rechs Styrekugle/Tie rod end/Kugelgelenk	14x1,5 RHT Yderste/Outer/Außen		5
6	5094701 Manchetsæt/Boot kit/Manschetten satz			6
7	5104722 Bøsning/Bushing/Buchsen			7
POS Golf Cabrio I (155) 1/79-8/93 & Golf I (17) 8/74-10/83				
Foraksel/Front axle/Vorneachse				
1	5004710 V/H - L/R (*) Styrestang/Steering rod/Spurstange			1
2	5014703 V/H - L/R Bærearmlenke/Track control arm/Querlenker			2
3	5024702 U Tandstang/Steering rack/Zahnstange			
4	5024702 U 1/79 - Tandstang/Steering rack/Zahnstange			
5	5034714 V/H - L/R Styrekugle/Tie rod end/Kugelgelenk	14x1,5 RHT Yderste/Outer/Außen		5
6	5034715 V/H - L/R (*) Styrekugle/Tie rod end/Axialgelenk	14x1,5 RHT Inderste/Inner		6
7	5044709 V/H - L/R CH. - 178 3173 583 Bærekugle/Ball joint/Radgelenk	Konus/Cone 15mm. Nederste/Lower/Unten		7
8	5044708 V/H - L/R CH. 178 3173 584- Bærekugle/Ball joint/Radgelenk	Konus/Cone 17mm. Nederste/Lower/Unten		8
9	5094703 (*) Manchetsæt/Boot kit/Manschetten satz			9
10	5104734 Bag/Rear/Hinten Bøsning/Bushing/Buchsen	V/H - L/R		10
11	5104735 For/Front/Vorne Bøsning/Bushing/Buchsen	V/H - L/R		11
				(*) Uden servostyring Without Power Steering Ohne Servolenkung















POS	Golf II (19E) 8/83-12/92				
Foraksel/Front axle/Vorneachse					
1	5004711 Venstre/Left/Links (*) Styrestang/Steering rod/Spurstange			1	
2	5004712 Højre/Right/Rechs (*) Styrestang/Steering rod/Spurstange			2	
3	5004750 U Venstre/Left/Links ZF (**) Styrestang/Steering rod/Spurstange				
4	5004751 U Højre/Right/Rechs ZF (**) Styrestang/Steering rod/Spurstange				
5	5004752 Venstre/Left/Links (**) 365 mm. RHT Styrestang/Steering rod/Spurstange			5	
6	5004753 Højre/Right/Rechs (**) 365 mm. LHT Styrestang/Steering rod/Spurstange			6	
7	5014710 V/H - L/R Bærearmlenke/Track control arm/Querlenker			7	
8	5024706 - 7/89 Tandstang/Steering rack/Zahnstange			8	
9	5034716 Højre/Right/Rechs Styrekugle/Tie rod end/Kugelgelenk	14x1,5 RHT Yderste/Outer/Außen			9
10	5034717 V/H - L/R (*) Styrekugle/Tie rod end/Axialgelenk	22x1,5 RHT Inderste/Inner			10
11	5034735 Venstre/Left/Links Styrekugle/Tie rod end/Kugelgelenk	14x1,5 RHT Yderste/Outer/Außen			11
<p>(*) Uden servostyring Without Power Steering Ohne Servolenkung</p> <p>(**) Med servostyring With Power Steering Mit Servolenkung</p>					
POS					
12	5044710 V/H - L/R Bærekugle/Ball joint/Radgelenk	CH. - 19HB/16HW 990 000 Konus/Cone 17mm. Nederste/Lower/Unten			12
13	5044720 V/H - L/R Bærekugle/Ball joint/Radgelenk	CH. 19JW/16JB 000 001- Konus/Cone 19mm. Nederste/Lower/Unten			13
14	5094704 (*) Manchetsæt/Boot kit/Manschetten satz			14	
15	5104705 Bag/Rear/Hinten V/H - L/R Bøsning/Bushing/Buchsen			15	
16	5104707 U V/H - L/R Bøsningssæt/Bushing set/Buchsen satz			16	
17	5104720 For/Front/Vorne V/H - L/R Bøsning/Bushing/Buchsen			17	
18	5104799 Bag/Rear/Hinten V/H - L/R Bøsning/Bushing/Buchsen			18	
19	5112304 V/H - L/R (1.8i) Ø15mm. 75 mm. Stabilisator/Stabilizer/Stabilisator			19	
20	5112305 V/H - L/R (-1.8i) Ø17mm. 75 mm. Stabilisator/Stabilizer/Stabilisator			20	
Bagaksel/Rear axle/Hinterachse					
21	5104724 V/H - L/R Bøsningssæt/Bushing set/Buchsen satz			21	













VOLKSWAGEN

POS		Golf Cabrio III (1EX0) 7/93-5/98 & Golf III (1HX0) 11/91-8/97 & Golf Variant III (1HXD) 7/93-4/99			
Foraksel/Front axle/Vorneachse					
1		5004734 Venstre/Left/Links (*) Styrestang/Steering rod/Spurstange		 1	
2		5004735 Højre/Right/Rechs (*) Styrestang/Steering rod/Spurstange		 2	
3		5004754 Venstre/Left/Links Styrestang/Steering rod/Spurstange	ZF (**) RHT	 3	
4		5004755 Højre/Right/Rechs Styrestang/Steering rod/Spurstange	ZF (**) LHT	 4	
5		5004756 Venstre/Left/Links Styrestang/Steering rod/Spurstange	TRW (**) 400 mm. RHT	 5	
6		5004757 Højre/Right/Rechs Styrestang/Steering rod/Spurstange	TRW (**) 400 mm. LHT	 6	
7		5014725 V/H - L/R Bærearmlenke/Track control arm/Querlenker	(-VR6/16V) Nederste/Lower/Unten	 7	 8
8		5014739 Venstre/Left/Links Bærearmlenke/Track control arm/Querlenker	(VR6/16V) Nederste/Lower/Unten		 9
9		5014740 Højre/Right/Rechs Bærearmlenke/Track control arm/Querlenker	(VR6/16V) Nederste/Lower/Unten		
10		5034716 Højre/Right/Rechs Styrekugle/Tie rod end/Kugelgelenk	14x1,5 RHT Yderste/Outer/Außen	 10	(*) Uden servostyring Without Power Steering Ohne Servolenkung
11		5034734 V/H - L/R (*) Styrekugle/Tie rod end/Axialgelenk	22x1,5 RHT Inderste/Inner	 11	(**) Med servostyring With Power Steering Mit Servolenkung
POS					
12		5034735 Venstre/Left/Links Styrekugle/Tie rod end/Kugelgelenk	14x1,5 RHT Yderste/Outer/Außen	 12	
13		5034746 V/H - L/R ZF (**) Styrekugle/Tie rod end/Axialgelenk	14x1,5 RHT Inderste/Inner	 13	
14		5044720 V/H - L/R Bærekugle/Ball joint/Radgelenk	Konus/Cone 19mm. Nederste/Lower/Unten	 14	
15		5044720 V/H - L/R (-VR6/16V) Bærekugle/Ball joint/Radgelenk	Konus/Cone 19mm. Nederste/Lower/Unten	 15	
16		5044734 V/H - L/R (VR6/16V) Bærekugle/Ball joint/Radgelenk	Konus/Cone 18mm. Nederste/Lower/Unten	 16	
17		5092313 ZF (**) Manchetsæt/Boot kit/Manschetten satz		 17	
18		5094704 (*) Manchetsæt/Boot kit/Manschetten satz		 18	
19		5094715 TRW (**) Manchetsæt/Boot kit/Manschetten satz		 19	
20		5104705 Bag/Rear/Hinten Bøsning/Bushing/Buchsen	V/H - L/R	 20	
21		5104720 For/Front/Vorne Bøsning/Bushing/Buchsen	V/H - L/R	 21	

POS		Golf Cabrio III (1EX0) 7/93-5/98 & Golf III (1HX0) 11/91-8/97 & Golf Variant III (1HXD) 7/93-4/99
Foraksel/Front axle/Vorneachse		
22		5104799 Bag/Rear/Hinten V/H - L/R Bøsning/Bushing/Buchsen  22
23		5112305 V/H - L/R (-16V & VR6 & Variant) Ø17mm. 75 mm. Stabilisator/Stabilizer/Stabilisator  23
24		5114725 V/H - L/R (16V & VR6 & Variant) Stabilisator bolt/Stabilizer bolt/Stabilisator bolzen  24
Bagaksel/Rear axle/Hinterachse		
25		5104726 V/H - L/R (- Cabrio/Variant) Bøsningssæt/Bushing set/Buchsen satz  25
26		5104727 V/H - L/R (Variant) Bøsningssæt/Bushing set/Buchsen satz  26
POS		Golf IV (1J) 8/97- & Golf IV Cabriolet (1E7) 6/98- & Golf IV Variant (1J) 5/99-
Foraksel/Front axle/Vorneachse		
1		5004772 Venstre/Left/Links - 12/97 Styrestang/Steering rod/Spurstange  1
2		5004773 Højre/Right/Rechs - 12/97 Styrestang/Steering rod/Spurstange  2
3		5014717 Venstre/Left/Links Bærearmlenke/Track control arm/Querlenker  3
4		5014718 Højre/Right/Rechs Bærearmlenke/Track control arm/Querlenker  4
5		5034753 Venstre/Left/Links - 12/97 14x1,5 RHT Styrekugle/Tie rod end/Kugelgelenk Yderste/Outer/Außen  5
6		5034753 Venstre/Left/Links - 12/97 14x1,5 RHT CH. - 1JWP050832/-1JWD039150/-1JWB027484/-1JWW062359 Styrekugle/Tie rod end/Kugelgelenk Yderste/Outer/Außen  6
7		5034754 Højre/Right/Rechs - 12/97 14x1,5 RHT Styrekugle/Tie rod end/Kugelgelenk Yderste/Outer/Außen  7
8		5034754 Højre/Right/Rechs - 12/97 14x1,5 RHT CH. - 1JWP050832/-1JWD039150/-1JWB027484/-1JWW062359 Styrekugle/Tie rod end/Kugelgelenk Yderste/Outer/Außen  8
9		5034757 V/H - L/R 1/98 - Styrekugle/Tie rod end/Axialgelenk 14x1,5 RHT Inderste/Inner  9
10		5034757 V/H - L/R 1/98- - Styrekugle/Tie rod end/Axialgelenk 14x1,5 RHT Inderste/Inner  10





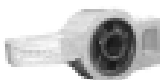









VOLKSWAGEN

POS	Golf IV (1J) 8/97- & Golf IV Cabriolet (1E7) 6/98- & Golf IV Variant (1J) 5/99-
Foraksel/Front axle/Vorneachse	
11	5034769 Højre/Right/Rechs 1/98 - 14x1,5 RHT CH. 1JWP050833-/1JWD039151-/1JWB027485-/1JWW062360- Styrekugle/Tie rod end/Kugelgelenk Yderste/Outer/Außen  11
12	5034770 Venstre/Left/Links 1/98 - 14x1,5 RHT CH. 1JWP050833-/1JWD039151-/1JWB027485-/1JWW062360- 1/98 - Styrekugle/Tie rod end/Kugelgelenk Yderste/Outer/Außen  12
13	5044738 Venstre/Left/Links Bærekugle/Ball joint/Radgelenk Nederste/Lower/Unten  13
14	5044739 Højre/Right/Rechs Bærekugle/Ball joint/Radgelenk Nederste/Lower/Unten  14
15	5094709 Manchetsæt/Boot kit/Manschetten satz
16	5104708 Bag/Rear/Hinten (-3.2 R32) V/H - L/R Bøsning/Bushing/Buchsen  16
17	5104720 For/Front/Vorne V/H - L/R Bøsning/Bushing/Buchsen  17
18	5104736 Bag/Rear/Hinten (-3.2 R32) V/H - L/R Bøsning/Bushing/Buchsen
19	5114702 V/H - L/R Ø10mm. 103 mm. Kunststof/Synthetic/Kunststoff Stabilisator arm/Stabilizer lever/Stabilisator hebel  19
POS	Golf V (1K1) 10/03-
Foraksel/Front axle/Vorneachse	
1	5014743 Venstre/Left/Links (- Diesel) Bærearmlenke/Track control arm/Querlenker Nederste/Lower/Unten  1
2	5014744 Højre/Right/Rechs (- Diesel) Bærearmlenke/Track control arm/Querlenker Nederste/Lower/Unten  2
3	5014745 Venstre/Left/Links (Diesel) Bærearmlenke/Track control arm/Querlenker Nederste/Lower/Unten
4	5014746 Højre/Right/Rechs (Diesel) Bærearmlenke/Track control arm/Querlenker Nederste/Lower/Unten
5	5034780 V/H - L/R 810 mm. 16x1,5 RHT Styrekugle/Tie rod end/Axialgelenk  5
6	5034781 Venstre/Left/Links 16x1,5 RHT Styrekugle/Tie rod end/Kugelgelenk  6
7	5034782 Højre/Right/Rechs 16x1,5 RHT Styrekugle/Tie rod end/Kugelgelenk  7
8	5044743 Venstre/Left/Links Bærekugle/Ball joint/Radgelenk Nederste/Lower/Unten  8
9	5044744 Højre/Right/Rechs Bærekugle/Ball joint/Radgelenk Nederste/Lower/Unten  9
10	5104737 Bag/Rear/Hinten Venstre/Left/Links Bøsning/Bushing/Buchsen Nederste/Lower/Unten  10

POS	 Golf V (1K1) 10/03-			
Foraksel/Front axle/Vorneachse				
11	5104738 Bag/Rear/Hinten Bøsning/Bushing/Buchsen	Højre/Right/Rechs Nederste/Lower/Unten		11
12	5104739 For/Front/Vorne Bøsning/Bushing/Buchsen	V/H - L/R Nederste/Lower/Unten		12
13	5114723 V/H - L/R 335 mm. Stabilisatorstang/Stabilizer rod/Diagonalstrebe			13
Bagaksel/Rear axle/Hinterachse				
14	5114726 V/H - L/R Stabilisator bolt/Stabilizer bolt/Stabilisator bolzen			14
POS	 Golf V Plus (1KP) 1/05-			
Foraksel/Front axle/Vorneachse				
1	5014743 Venstre/Left/Links Bærearmlenke/Track control arm/Querlenker	(- Diesel) Nederste/Lower/Unten		1
2	5014744 Højre/Right/Rechs Bærearmlenke/Track control arm/Querlenker	(- Diesel) Nederste/Lower/Unten		2
3	5014745 Venstre/Left/Links Bærearmlenke/Track control arm/Querlenker	(Diesel) Nederste/Lower/Unten		
4	5014746 Højre/Right/Rechs Bærearmlenke/Track control arm/Querlenker	(Diesel) Nederste/Lower/Unten		
5	5034780 V/H - L/R 810 mm. Styrekugle/Tie rod end/Axialgelenk	16x1,5 RHT		5
6	5034781 Venstre/Left/Links Styrekugle/Tie rod end/Kugelgelenk	16x1,5 RHT		6
7	5034782 Højre/Right/Rechs Styrekugle/Tie rod end/Kugelgelenk	16x1,5 RHT		7
8	5044743 Venstre/Left/Links Bærekugle/Ball joint/Radgelenk	Nederste/Lower/Unten		
9	5044744 Højre/Right/Rechs Bærekugle/Ball joint/Radgelenk	Nederste/Lower/Unten		9
10	5104737 Bag/Rear/Hinten Bøsning/Bushing/Buchsen	Venstre/Left/Links Nederste/Lower/Unten		10

POS	Golf V Plus (1KP) 1/05-				
Foraksel/Front axle/Vorneachse					
11	5104738 Bag/Rear/Hinten Bøsning/Bushing/Buchsen	Højre/Right/Rechs Nederste/Lower/Unten			11
12	5104739 For/Front/Vorne Bøsning/Bushing/Buchsen	V/H - L/R Nederste/Lower/Unten			12
13	5114723 V/H - L/R 335 mm. Stabilisatorstang/Stabilizer rod/Diagonalstrebe				13
POS	Jetta I (17) 8/74-2/84				
Foraksel/Front axle/Vorneachse					
1	5004710 V/H - L/R (*) Styrestang/Steering rod/Spurstange				1
2	5014703 V/H - L/R Bæream/Track control arm/Querlenker				2
3	5024702 U 1/79 - Tandstang/Steering rack/Zahnstange				
4	5034714 V/H - L/R Styrekugle/Tie rod end/Kugelgelenk	14x1,5 RHT Yderste/Outer/Außen			4
5	5034715 V/H - L/R (*) Styrekugle/Tie rod end/Axialgelenk	14x1,5 RHT Inderste/Inner			5
6	5044708 V/H - L/R CH. 178 3173 584- Bærekugle/Ball joint/Radgelenk	Konus/Cone 17mm. Nederste/Lower/Unten			6
7	5044709 V/H - L/R CH. - 178 3173 583 Bærekugle/Ball joint/Radgelenk	Konus/Cone 15mm. Nederste/Lower/Unten			7
8	5094703 (*) Manchetsæt/Boot kit/Manschetten satz				8
9	5104734 Bag/Rear/Hinten Bøsning/Bushing/Buchsen	V/H - L/R			9
10	5104735 For/Front/Vorne Bøsning/Bushing/Buchsen	V/H - L/R			10

POS	Jetta II (19E) 1/84-12/91				
Foraksel/Front axle/Vorneachse					
1	5004711 Venstre/Left/Links (*) Styrestang/Steering rod/Spurstange			1	
2	5004712 Højre/Right/Rechs (*) Styrestang/Steering rod/Spurstange			2	
3	5004750 U Venstre/Left/Links Styrestang/Steering rod/Spurstange	ZF (**)			
4	5004751 U Højre/Right/Rechs Styrestang/Steering rod/Spurstange	ZF (**)			
5	5004752 Venstre/Left/Links Styrestang/Steering rod/Spurstange	(**) 365 mm. RHT			
6	5004753 Højre/Right/Rechs Styrestang/Steering rod/Spurstange	(**) 365 mm. LHT			
7	5014710 V/H - L/R Bærearmlenker/Track control arm/Querlenker			7	
8	5024706 - 7/89 Tandstang/Steering rack/Zahnstange			8	
9	5034716 Højre/Right/Rechs Styrekugle/Tie rod end/Kugelgelenk	14x1,5 RHT Yderste/Outer/Außen		9	
10	5034717 V/H - L/R (*) Styrekugle/Tie rod end/Axialgelenk	22x1,5 RHT Inderste/Inner		10	(*) Uden servostyring Without Power Steering Ohne Servolenkung
11	5034735 Venstre/Left/Links Styrekugle/Tie rod end/Kugelgelenk	14x1,5 RHT Yderste/Outer/Außen		11	(**) Med servostyring With Power Steering Mit Servolenkung
Bagaksel/Rear axle/Hinterachse					
12	5044710 V/H - L/R CH. - 19HB/16HW 990 000 - 7/87 Bærekugle/Ball joint/Radgelenk	Konus/Cone 17mm. Nederste/Lower/Unten		12	
13	5044720 V/H - L/R CH. 19JW/16JB 000 001- 8/87 - Bærekugle/Ball joint/Radgelenk	Konus/Cone 19mm. Nederste/Lower/Unten		13	
14	5094704 (*) Manchetsæt/Boot kit/Manschetten satz			14	
15	5104705 Bag/Rear/Hinten Bøsning/Bushing/Buchsen	V/H - L/R		15	
16	5104707 U V/H - L/R Bøsningssæt/Bushing set/Buchsen satz			16	
17	5104720 For/Front/Vorne Bøsning/Bushing/Buchsen	V/H - L/R		17	
18	5104799 Bag/Rear/Hinten Bøsning/Bushing/Buchsen	V/H - L/R		18	
19	5112305 V/H - L/R Ø17mm. 75 mm. Stabilisator/Stabilizer/Stabilisator			19	
20	5104724 V/H - L/R Bøsningssæt/Bushing set/Buchsen satz			20	

POS	 LT 28/31/35 & Diesel (281-293) 4/75-4/96			
Foraksel/Front axle/Vorneachse				
1	5004720 Venstre/Left/Links Styrestang/Steering rod/Spurstange	CH. - 28D 004 508		1
2	5004721 Højre/Right/Rechs Styrestang/Steering rod/Spurstange	CH. - 28D 004 508		2
3	5004722 Midt/Center/Mitte Styrestang/Steering rod/Spurstange			3
4	5004723 Styrestang langs i førerside/Steering rod along driver's side/Spurstange komplett			4
5	5034723 CH. - 28D 004 508 Styrekugle/Tie rod end/Kugelgelenk	14x1,5 LHT Inderste/Inner		5
6	5034724 CH. - 28D 004 508 Styrekugle/Tie rod end/Kugelgelenk	14x1,5 RHT Yderste/Outer/Außen		6
7	5034725 Højre/Right/Rechs Styrekugle/Tie rod end/Kugelgelenk	16x1,5 RHT Yderste/Outer/Außen		7
8	5034732 Venstre/Left/Links Styrekugle/Tie rod end/Kugelgelenk	CH. 28D 004 509- 16x1,5 LHT Yderste/Outer/Außen		8
9	5034733 Højre/Right/Rechs Styrekugle/Tie rod end/Kugelgelenk	CH. 28D 004 509- 16x1,5 RHT Yderste/Outer/Außen		9
10	5044716 V/H - L/R Bærekugle/Ball joint/Radgelenk	Øverste/Upper/Oben		10
11	5044717 V/H - L/R Bærekugle/Ball joint/Radgelenk	Nederste/Lower/Unten		11
POS				
12	5104712 Bag/Rear/Hinten Indvendig/Inner/Innen30 mm. Bøsning/Bushing/Buchsen	V/H - L/R Udvendig/Outer/Außen66 mm.		12
13	5104713 For/Front/Vorne Indvendig/Inner/Innen30 mm. Bøsning/Bushing/Buchsen	V/H - L/R Udvendig/Outer/Außen66 mm.		13







POS	LT 40/45/50 8/78-5/96			
Foraksel/Front axle/Vorneachse				
1	5004743 Venstre/Left/Links Styrestang/Steering rod/Spurstange		1	
2	5044716 V/H - L/R Bærekugle/Ball joint/Radgelenk	Øverste/Upper/Oben		2
3	5044717 V/H - L/R Bærekugle/Ball joint/Radgelenk	Nederste/Lower/Unten		3
4	5104712 Bag/Rear/Hinten Indvendig/Inner/Innen30 mm. Bøsning/Bushing/Buchsen	V/H - L/R Udvendig/Outer/Außen66 mm.		4
5	5104713 For/Front/Vorne Indvendig/Inner/Innen30 mm. Bøsning/Bushing/Buchsen	V/H - L/R Udvendig/Outer/Außen66 mm.		5
POS	LT 28-35 II, LT 28-46 II 5/96-			
Foraksel/Front axle/Vorneachse				
1	5013345 Venstre/Left/Links Bærearmlenke/Track control arm/Querlenker	Nederste/Lower/Unten		1
2	5013346 Højre/Right/Rechs Bærearmlenke/Track control arm/Querlenker	Nederste/Lower/Unten		2
3	5033336 V/H - L/R Styrekugle/Tie rod end/Axialgelenk	16x1,5 RHT Inderste/Inner		3
4	5033337 V/H - L/R Styrekugle/Tie rod end/Kugelgelenk	16x1,5 Yderste/Outer/Außen		4
5	5043311 V/H - L/R Bærekugle/Ball joint/Radgelenk	Nederste/Lower/Unten		5
6	5113307 Venstre/Left/Links Stabilisator/Stabilizer/Stabilisator	Ø14mm. 115 mm.		6
7	5113308 Højre/Right/Rechs Stabilisator/Stabilizer/Stabilisator	Ø14mm. 115 mm.		7
Bagaksel/Rear axle/Hinterachse				
8	5113309 V/H - L/R (LT 28-35) Stabilisator/Stabilizer/Stabilisator	Ø12mm. 95 mm.		8

VOLKSWAGEN















POS	Lupo 4/97-				
Foraksel/Front axle/Vorneachse					
1	5014737 V/H - L/R Bærearml/Track control arm/Querlenker	Nederste/Lower/Unten			1
2	5032358 V/H - L/R (*) Styrekugle/Tie rod end/Axialgelenk	14x1,5 RHT Inderste/Inner			2
3	5034716 Højre/Right/Rechs (*) Styrekugle/Tie rod end/Kugelgelenk	14x1,5 RHT Yderste/Outer/Außen			3
4	5034735 Venstre/Left/Links (*) Styrekugle/Tie rod end/Kugelgelenk	14x1,5 RHT Yderste/Outer/Außen			4
5	5034759 Venstre/Left/Links (**) Styrekugle/Tie rod end/Kugelgelenk	14x1,5 RHT Yderste/Outer/Außen			5
6	5034760 Højre/Right/Rechs (**) Styrekugle/Tie rod end/Kugelgelenk	14x1,5 RHT Yderste/Outer/Auf			6
7	5034761 V/H - L/R (**) Styrekugle/Tie rod end/Axialgelenk	14x1,5 Inderste/Inner			7
8	5044731 Venstre/Left/Links Bærekugle/Ball joint/Radgelenk	Nederste/Lower/Unten			8
9	5044732 Højre/Right/Rechs Bærekugle/Ball joint/Radgelenk	Nederste/Lower/Unten			9
10	5094301 (1.2 & 1.7) Manchetsæt/Boot kit/Manschetten satz				10
<p>(*) Uden servostyring Without Power Steering Ohne Servolenkung</p> <p>(**) Med servostyring With Power Steering Mit Servolenkung</p>					
POS					
11	5094707 (-1.2 & 1.7) Manchetsæt/Boot kit/Manschetten satz				11
12	5102314 Bag/Rear/Hinten Bøsning/Bushing/Buchsen	V/H - L/R			12
13	5102315 For/Front/Vorne Bøsning/Bushing/Buchsen	V/H - L/R			13
14	5112304 V/H - L/R Stabilisator/Stabilizer/Stabilisator	Ø15mm. 75 mm.			14
15	5112312 V/H - L/R Stabilisator bolt/Stabilizer bolt/Stabilisator bolzen	Ø18mm. 75 mm.			15
16	5114746 V/H - L/R 1999 - Stabilisator/Stabilizer/Stabilisator	Ø10mm. 53 mm.			16

POS	New Beetle 1/98-				
		Foraksel/Front axle/Vorneachse			
1	5014717 Venstre/Left/Links Bærearml/Track control arm/Querlenker		1		
2	5014718 Højre/Right/Rechs Bærearml/Track control arm/Querlenker		2		
3	5034757 V/H - L/R Styrekugle/Tie rod end/Axialgelenk			14x1,5 RHT Inderste/Inner	
4	5034769 Højre/Right/Rechs Styrekugle/Tie rod end/Kugelgelenk			14x1,5 RHT Yderste/Outer/Außen	
5	5034770 Venstre/Left/Links Styrekugle/Tie rod end/Kugelgelenk			14x1,5 RHT Yderste/Outer/Außen	
6	5044738 Venstre/Left/Links Bærekugle/Ball joint/Radgelenk			Nederste/Lower/Unten	
7	5044739 Højre/Right/Rechs Bærekugle/Ball joint/Radgelenk			Nederste/Lower/Unten	
8	5094709 Manchetsæt/Boot kit/Manschetten satz				
9	5104708 Bag/Rear/Hinten Bøsning/Bushing/Buchsen			V/H - L/R (-RSI 3.2)	
10	5104720 For/Front/Vorne Bøsning/Bushing/Buchsen			V/H - L/R	
POS					
11	5104736 Bag/Rear/Hinten Bøsning/Bushing/Buchsen			V/H - L/R (-RSI 3.2)	
12	5114702 V/H - L/R Ø10mm. 103 mm. Stabilisator arm/Stabilizer lever/Stabilisator hebel			Kunststof/Synthetic/Kunststoff	

VOLKSWAGEN

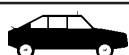
POS	 Passat (32/33) 7/73-7/80 & Passat Variant (32/33) 10/73-7/80
	Foraksel/Front axle/Vorneachse
1	5004713 U V/H - L/R Styrestang/Steering rod/Spurstange  1
2	5044711 V/H - L/R CH. 328 2002 001- Konus/Cone 17mm. Bærekugle/Ball joint/Radgelenk Nederste/Lower/Unten  2
POS	 Passat Automatic 7/73-7/80
	Foraksel/Front axle/Vorneachse
1	5004713 U Venstre/Left/Links Styrestang/Steering rod/Spurstange  1
2	5044711 V/H - L/R CH. 328 2002 001- Konus/Cone 17mm. Bærekugle/Ball joint/Radgelenk Nederste/Lower/Unten  2





















VOLKSWAGEN

POS		Passat (32B) 8/80-88 & Passat Variant (32B) 8/80-88 & Santana (32B) 8/80-88			
Foraksel/Front axle/Vorneachse					
1	5004714 Venstre/Left/Links Styrestang/Steering rod/Spurstange	(- 5 Cyl./Zyl. 2.2 & 2.3)		1	
2	5004715 Højre/Right/Rechs Styrestang/Steering rod/Spurstange	(Mod. 1986) CH. - 32G 275000		2	
3	5004715 Højre/Right/Rechs Styrestang/Steering rod/Spurstange	(Mod. 1987) CH. - 32/33H 150000		3	
4	5004733 Højre/Right/Rechs Styrestang/Steering rod/Spurstange	(Mod. 1986) CH. 32G 275001-		4	
5	5004733 Højre/Right/Rechs Styrestang/Steering rod/Spurstange	(Mod. 1987) CH. 32/33H 150001-		5	
6	5004758 U Venstre/Left/Links Styrestang/Steering rod/Spurstange	RHT (5 Cyl./Zyl. 2.2 & 2.3)		6	
7	5034720 V/H - L/R Styrekugle/Tie rod end/Kugelgelenk	14x1,5 RHT Yderste/Outer/Außen		7	
8	5044711 V/H - L/R (*) Bærekugle/Ball joint/Radgelenk	Konus/Cone 17mm. Nederste/Lower/Unten		9	
9	5044735 Venstre/Left/Links Bærekugle/Ball joint/Radgelenk	(**) Nederste/Lower/Unten		10	(*) Uden servostyring Without Power Steering Ohne Servolenkung
10	5044736 Højre/Right/Rechs Bærekugle/Ball joint/Radgelenk	(**) Nederste/Lower/Unten			(**) Med servostyring With Power Steering Mit Servolenkung
POS					
11	5092313 ZF (**) Manchetsæt/Boot kit/Manschetten satz			11	
12	5104701 Bag/Rear/Hinten V/H - L/R (*) Bøsning/Bushing/Buchsen			12	
13	5104702 Bag/Rear/Hinten V/H - L/R (**) Bøsning/Bushing/Buchsen			13	

POS	Passat (35I) 2/88-8/96 & Passat Variant (35I) 2/88-5/97			
Foraksel/Front axle/Vorneachse				
1	5004736 Venstre/Left/Links (*) Styrestang/Steering rod/Spurstange		1	
2	5004737 Højre/Right/Rechs (*) Styrestang/Steering rod/Spurstange		2	
3	5004759 Venstre/Left/Links Styrestang/Steering rod/Spurstange	(-1.9 TDI 110 HK/16V/VR6) (**)	LHT	
4	5004760 Højre/Right/Rechs Styrestang/Steering rod/Spurstange	(-1.9 TDI 110 HK/16V/VR6) (**)		
5	5004765 V/H - L/R CH. 31N 255990- CH. - 3A R 099264 - 9/93 Styrestang/Steering rod/Spurstange	(1.9 TDI 110 HK/16V/VR6)		
6	5014726 V/H - L/R Bærearmlenke/Track control arm/Querlenker	Nederste/Lower/Unten		
7	5014732 V/H - L/R Bærearmlenke m/bærekugle/Track control arm with ball joint/Querlenker mit Radgelenk	Nederste/Lower/Unten		
8	5034716 Højre/Right/Rechs - 9/93 CH. - 3AR099264 Styrekugle/Tie rod end/Kugelgelenk	(-1.9 TDI 110 HK/16V/VR6) 14x1,5 RHT		
9	5034735 Venstre/Left/Links - 9/93 Styrekugle/Tie rod end/Kugelgelenk	(-1.9 TDI 110 HK/16V/VR6) 14x1,5 RHT		
10	5034735 Venstre/Left/Links - 9/93 CH. - 3AR099264 Styrekugle/Tie rod end/Kugelgelenk	(-1.9 TDI 110 HK/16V/VR6) 14x1,5 RHT		
POS				
11	5034737 V/H - L/R (*) Styrekugle/Tie rod end/Axialgelenk	22x1,5 RHT Inderste/Inner		
12	5034747 V/H - L/R ZF (**) Styrekugle/Tie rod end/Axialgelenk	14x1,5 RHT Inderste/Inner		
13	5034763 Venstre/Left/Links CH. - 3AR099265 10/93 - Styrekugle/Tie rod end/Kugelgelenk	(-1.9 TDI 110 HK/16V/VR6) 14x1,5 RHT Konus/Cone 14,0mm. Yderste/Outer/Außen		
14	5034763 Venstre/Left/Links 10/93 - CH. 3AR099265- Styrekugle/Tie rod end/Kugelgelenk	(-1.9 TDI 110 HK/16V/VR6) 14x1,5 RHT Konus/Cone 14,0mm. Yderste/Outer/Außen		
15	5034764 Højre/Right/Rechs 10/93 - CH. - 3AR099265 Styrekugle/Tie rod end/Kugelgelenk	(-1.9 TDI 110 HK/16V/VR6) 14x1,5 RHT Konus/Cone 14,0mm. Yderste/Outer/Außen		
16	5034764 Højre/Right/Rechs 10/93 - CH. 3AR099265- Styrekugle/Tie rod end/Kugelgelenk	(-1.9 TDI 110 HK/16V/VR6) 14x1,5 RHT Konus/Cone 14,0mm. Yderste/Outer/Außen		
17	5034773 V/H - L/R 10/93 - Styrekugle/Tie rod end/Kugelgelenk	(1.9 TDI 110 HK/16V/VR6) 14x1,5 RHT Yderste/Outer/Außen		
18	5044720 V/H - L/R Bærekugle/Ball joint/Radgelenk	Konus/Cone 19mm. Nederste/Lower/Unten		
19	5092313 ZF (**) Manchetsæt/Boot kit/Manschettensatz			



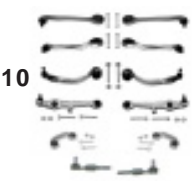







(*) Uden servostyring
Without Power Steering
Ohne Servolenkung

(**) Med servostyring
With Power Steering
Mit Servolenkung

POS	 Passat (35I) 2/88-8/96 & Passat Variant (35I) 2/88-5/97		
Foraksel/Front axle/Vorneachse			
20	5094704 (*) Manchetsæt/Boot kit/Manschetten satz		20
21	5094715 TRW (**) Manchetsæt/Boot kit/Manschetten satz		21
22	5104705 Bag/Rear/Hinten V/H - L/R Bøsning/Bushing/Buchsen		22
23	5104720 For/Front/Vorne V/H - L/R Bøsning/Bushing/Buchsen		23
24	5104799 Bag/Rear/Hinten V/H - L/R Bøsning/Bushing/Buchsen		24
25	5114707 V/H - L/R Ø21mm. 79 mm. Stabilisator bolt/Stabilizer bolt/Stabilisator bolzen		25
26	5114727 V/H - L/R Ø19mm. 79 mm. Stabilisator bolt/Stabilizer bolt/Stabilisator bolzen		26
27	5114728 V/H - L/R Ø23mm. 79 mm. Stabilisator bolt/Stabilizer bolt/Stabilisator bolzen		27
Bagaksel/Rear axle/Hinterachse			
28	5104725 V/H - L/R Bøsningssæt/Bushing set/Buchsen satz		28
			(*) Uden servostyring Without Power Steering Ohne Servolenkung
			(**) Med servostyring With Power Steering Mit Servolenkung
POS	 Passat (3B2) 8/96-11/00 & Passat Variant (3B5) 3/97-11/00		
Foraksel/Front axle/Vorneachse			
1	5004774 V/H - L/R Styrestang/Steering rod/Spurstange		1
2	5014716 For/Front/Vorne Bærearmlenke/Track control arm/Querlenker	V/H - L/R Nederste/Lower/Unten	
3	5014719 Bag/Rear/Hinten Bærearmlenke/Track control arm/Querlenker	Venstre/Left/Links Nederste/Lower/Unten	
4	5014720 Bag/Rear/Hinten Bærearmlenke/Track control arm/Querlenker	Højre/Right/Rechs Nederste/Lower/Unten	
5	5014727 For/Front/Vorne Bærearmlenke/Track control arm/Querlenker	Venstre/Left/Links Øverste/Upper/Oben	
6	5014728 For/Front/Vorne Bærearmlenke/Track control arm/Querlenker	Højre/Right/Rechs Øverste/Upper/Oben	
7	5014733 Bag/Rear/Hinten Bærearmlenke/Track control arm/Querlenker	Venstre/Left/Links Øverste/Upper/Oben	
8	5014734 Bag/Rear/Hinten Bærearmlenke/Track control arm/Querlenker	Højre/Right/Rechs Øverste/Upper/Oben	
10	5014738 V/H - L/R Bærearmlenkesæt/Track control arm kit/Querlenker satz		10
11	5034755 V/H - L/R Styrekugle/Tie rod end/Axialgelenk	14x1,5 RHT Inderste/Inner	

VOLKSWAGEN

POS	Passat (3B2) 8/96-11/00 & Passat Variant (3B5) 3/97-11/00			
Foraksel/Front axle/Vorneachse				
12	5034756 V/H - L/R Styrekugle/Tie rod end/Kugelgelenk	14x1,5 RHT Yderste/Outer/Außen		12
13	5104714 For/Front/Vorne Bøsning/Bushing/Buchsen	V/H - L/R		13
14	5104715 Bag/Rear/Hinten Bøsning/Bushing/Buchsen	V/H - L/R		14
15	5104716 V/H - L/R Bøsning/Bushing/Buchsen	Nederste/Lower/Unten		15
16	5104717 V/H - L/R Bøsning/Bushing/Buchsen	Øverste/Upper/Oben		16
17	5114705 V/H - L/R CH. - 3BXP213726 70 mm. Stabilisatorstang/Stabilizer rod/Diagonalstrebe			17
18	5114717 Venstre/Left/Links CH. 3BXP213727- 90 mm. Aluminium Stabilisatorstang/Stabilizer rod/Diagonalstrebe			18
19	5114718 Højre/Right/Rechs CH. 3BXP213727- 90 mm. Aluminium Stabilisatorstang/Stabilizer rod/Diagonalstrebe			19
POS	Passat (3B3) 11/00- & Passat Variant (3B6) 11/00-			
Foraksel/Front axle/Vorneachse				
1	5004774 V/H - L/R Styrestang/Steering rod/Spurstange			1
2	5014719 Bag/Rear/Hinten Bærearmlenke/Track control arm/Querlenker	Venstre/Left/Links Nederste/Lower/Unten		2
3	5014720 Bag/Rear/Hinten Bærearmlenke/Track control arm/Querlenker	Højre/Right/Rechs Nederste/Lower/Unten		3
4	5014727 For/Front/Vorne Bærearmlenke/Track control arm/Querlenker	Venstre/Left/Links Øverste/Upper/Oben		4
5	5014728 For/Front/Vorne Bærearmlenke/Track control arm/Querlenker	Højre/Right/Rechs Øverste/Upper/Oben		5
6	5014733 Bag/Rear/Hinten CH. 3BVE083009/-3BVP102594- Bærearmlenke/Track control arm/Querlenker	Venstre/Left/Links Øverste/Upper/Oben		6
7	5014734 Bag/Rear/Hinten CH. 3BVE083009/-3BVP102594- Bærearmlenke/Track control arm/Querlenker	Højre/Right/Rechs Øverste/Upper/Oben		7
8	5014738 V/H - L/R Bærearmlenke sæt/Track control arm kit/Querlenker satz	CH. - 3B-3-072-000		8
9	5014747 For/Front/Vorne Bærearmlenke/Track control arm/Querlenker	V/H - L/R Nederste/Lower/Unten		9





















POS	 Passat (3B3) 11/00- & Passat Variant (3B6) 11/00-
Foraksel/Front axle/Vorneachse	
10	5034755 V/H - L/R Styrekugle/Tie rod end/Axialgelenk 14x1,5 RHT Inderste/Inner  10
11	5034756 V/H - L/R Styrekugle/Tie rod end/Kugelgelenk 14x1,5 RHT Yderste/Outer/Außen  11
12	5104714 For/Front/Vorne Bøsning/Bushing/Buchsen V/H - L/R  12
13	5104715 Bag/Rear/Hinten Bøsning/Bushing/Buchsen V/H - L/R  13
14	5104716 V/H - L/R Bøsning/Bushing/Buchsen Nederste/Lower/Unten  14
15	5104717 V/H - L/R Bøsning/Bushing/Buchsen Øverste/Upper/Oben  15
16	5114717 Venstre/Left/Links Stabilisatorstang/Stabilizer rod/Diagonalstrebe 90 mm. Aluminium  16
17	5114718 Højre/Right/Rechs Stabilisatorstang/Stabilizer rod/Diagonalstrebe 90 mm. Aluminium  17
Bagaksel/Rear axle/Hinterachse	
18	5114748 V/H - L/R 62,5 mm. Stabilisator/Stabilizer/Stabilisator  18
POS	 Pheaton (3D2) 4/02-
Foraksel/Front axle/Vorneachse	
1	XXXXXXXX Bag/Rear/Hinten Bærearmlenke/Track control arm/Querlenker Venstre/Left/Links
2	XXXXXXXX Bag/Rear/Hinten Bærearmlenke/Track control arm/Querlenker Højre/Right/Rechs
3	XXXXXXXX For/Front/Vorne Bærearmlenke/Track control arm/Querlenker Venstre/Left/Links
4	XXXXXXXX For/Front/Vorne Bærearmlenke/Track control arm/Querlenker Højre/Right/Rechs

VOLKSWAGEN

POS	Polo (86) 4/75-9/81		
Foraksel/Front axle/Vorneachse			
1	5004706 U Venstre/Left/Links Styrestang/Steering rod/Spurstange	CH. 8662300001 - CH. 86/87C200000	1
2	5014701 V/H - L/R Ø17mm. Bærearml/Track control arm/Querlenker	CH. 869 2523 523-	2
3	5014702 U CH. - 869 2523 522 Bærearml/Track control arm/Querlenker	Ø14mm.	3
4	5024701 Tandstang/Steering rack/Zahnstange		4
5	5034712 Højre/Right/Rechs Styrekugle/Tie rod end/Kugelgelenk	14x1,5 RHT Yderste/Outer/Außen	5
6	5094701 9/79 - Manchetsæt/Boot kit/Manschetten satz		6
7	5104721 For/Front/Vorne Bøsning/Bushing/Buchsen	V/H - L/R	7
8	5104722 Bag/Rear/Hinten Bøsning/Bushing/Buchsen	V/H - L/R	8
POS	Polo (86C) 10/81-8/94		
Foraksel/Front axle/Vorneachse			
1	5004708 Venstre/Left/Links Styrestang/Steering rod/Spurstange	CH. 86/87D000001 - CH. 80RY150000	1
2	5004709 Højre/Right/Rechs Styrestang/Steering rod/Spurstange	CH. 86/87D000001 - CH. 80RY150000	2
3	5014701 V/H - L/R Ø17mm. Bærearml/Track control arm/Querlenker		3
4	5024701 Tandstang/Steering rack/Zahnstange		4
5	5034712 Højre/Right/Rechs Styrekugle/Tie rod end/Kugelgelenk	14x1,5 RHT Yderste/Outer/Außen	5
6	5094701 Manchetsæt/Boot kit/Manschetten satz		6
7	5104721 For/Front/Vorne Bøsning/Bushing/Buchsen	V/H - L/R	7
8	5104722 Bag/Rear/Hinten Bøsning/Bushing/Buchsen	V/H - L/R	8























POS	Polo (6N) 10/94-10/99				
Foraksel/Front axle/Vorneachse					
1	5004748 Venstre/Left/Links (*) Styrestang/Steering rod/Spurstange	Konus/Cone 14mm.		1	
2	5004749 Højre/Right/Rechs (*) Styrestang/Steering rod/Spurstange	Konus/Cone 14mm.		2	
3	5004775 Venstre/Left/Links (**) Styrestang/Steering rod/Spurstange			3	
4	5004776 Højre/Right/Rechs (**) Styrestang/Steering rod/Spurstange			4	
5	5012343 V/H - L/R Bærearmlenke/Track control arm/Querlenker	Nederste/Lower/Unten		5	
6	5032358 V/H - L/R (*) Styrekugle/Tie rod end/Axialgelenk	14x1,5 RHT Inderste/Inner		6	
7	5034716 Højre/Right/Rechs (**) CH. - 6NWX078256,6NWX078256 Styrekugle/Tie rod end/Kugelgelenk	14x1,5 RHT Yderste/Outer/Außen		7	
8	5034716 Højre/Right/Rechs (*) Styrekugle/Tie rod end/Kugelgelenk	14x1,5 RHT Yderste/Outer/Außen		8	
9	5034735 Venstre/Left/Links (**) CH. - 6NWX078256,6NWX078256 Styrekugle/Tie rod end/Kugelgelenk	14x1,5 RHT Yderste/Outer/Außen		9	(*) Uden servostyring Without Power Steering Ohne Servolenkung
10	5034735 Venstre/Left/Links (*) Styrekugle/Tie rod end/Kugelgelenk	14x1,5 RHT Yderste/Outer/Außen		10	(**) Med servostyring With Power Steering Mit Servolenkung
POS					
11	5034759 Venstre/Left/Links (**) CH. 6NWX078257,6NWX078257- Styrekugle/Tie rod end/Kugelgelenk	14x1,5 RHT Yderste/Outer/Außen		11	
12	5034760 Højre/Right/Rechs (**) CH. 6NWX078257,6NWX078257- Styrekugle/Tie rod end/Kugelgelenk	14x1,5 RHT Yderste/Outer/Außen		12	
13	5034762 V/H - L/R (**) Styrekugle/Tie rod end/Axialgelenk	14x1,5 RHT Inderste/Inner		13	
14	5044731 Venstre/Left/Links Bærekugle/Ball joint/Radgelenk	Nederste/Lower/Unten		14	
15	5044732 Højre/Right/Rechs Bærekugle/Ball joint/Radgelenk	Nederste/Lower/Unten		15	
16	5094707 (*) Manchetsæt/Boot kit/Manschetten satz			16	
17	5094708 (**) Manchetsæt/Boot kit/Manschetten satz			17	
18	5102314 Bag/Rear/Hinten V/H - L/R Bøsning/Bushing/Buchsen			18	
19	5102315 For/Front/Vorne V/H - L/R Bøsning/Bushing/Buchsen			19	
20	5112304 V/H - L/R Ø15mm. 75 mm. Stabilisator/Stabilizer/Stabilisator			20	
21	5112312 V/H - L/R Ø18mm. 75 mm. Stabilisator bolt/Stabilizer bolt/Stabilisator bolzen			21	













VOLKSWAGEN







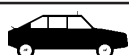







POS	 Polo Van (6NF) 10/94-			
Foraksel/Front axle/Vorneachse				
1	5004748 Venstre/Left/Links (*) Styrestang/Steering rod/Spurstange	Konus/Cone 14mm.		1
2	5004749 Højre/Right/Rechs (*) Styrestang/Steering rod/Spurstange	Konus/Cone 14mm.		2
3	5012343 V/H - L/R Bærearmlenke/Track control arm/Querlenker	Nederste/Lower/Unten		3
4	5034735 V/H - L/R (*) Styrekugle/Tie rod end/Kugelgelenk	14x1,5 RHT Yderste/Outer/Außen		4
5	5044731 Venstre/Left/Links Bærekugle/Ball joint/Radgelenk	Nederste/Lower/Unten		5
6	5044732 Højre/Right/Rechs Bærekugle/Ball joint/Radgelenk	Nederste/Lower/Unten		6
7	5102314 Bag/Rear/Hinten Bøsning/Bushing/Buchsen	V/H - L/R		7
8	5102315 For/Front/Vorne Bøsning/Bushing/Buchsen	V/H - L/R		8
(*) Uden servostyring Without Power Steering Ohne Servolenkung				
(**) Med servostyring With Power Steering Mit Servolenkung				
POS	 Polo Classic (6KV2) 11/95-9/01 & Polo Variant (6KV5) 5/97-9/01			
Foraksel/Front axle/Vorneachse				
1	5014710 V/H - L/R Bærearmlenke/Track control arm/Querlenker			1
2	5034763 Venstre/Left/Links Styrekugle/Tie rod end/Kugelgelenk	14x1,5 RHT Konus/Cone 14,0mm. Yderste/Outer/Außen		2
3	5034764 Højre/Right/Rechs Styrekugle/Tie rod end/Kugelgelenk	14x1,5 RHT Konus/Cone 14,0mm. Yderste/Outer/Außen		3
4	5044720 V/H - L/R Bærekugle/Ball joint/Radgelenk	Konus/Cone 19mm. Nederste/Lower/Unten		4
5	5094707 (*) Manchetsæt/Boot kit/Manschetten satz			5
6	5094708 (**) Manchetsæt/Boot kit/Manschetten satz			6
7	5104705 Bag/Rear/Hinten Bøsning/Bushing/Buchsen	V/H - L/R		7
8	5104799 Bag/Rear/Hinten Bøsning/Bushing/Buchsen	V/H - L/R		8
9	5112304 V/H - L/R Ø15mm. 75 mm. Stabilisator/Stabilizer/Stabilisator			9
10	5112312 V/H - L/R Ø18mm. 75 mm. Stabilisator bolt/Stabilizer bolt/Stabilisator bolzen			9















POS	Polo (6N2) 10/99-9/01					
Foraksel/Front axle/Vorneachse						
1	5004775 Venstre/Left/Links (**) Styrestang/Steering rod/Spurstange				1	
2	5004776 Højre/Right/Rechs (**) Styrestang/Steering rod/Spurstange				2	
3	5012343 V/H - L/R Bærearml/Track control arm/Querlenker	Nederste/Lower/Unten			3	
4	5032358 V/H - L/R (*) Styrekugle/Tie rod end/Axialgelenk	14x1,5 RHT Inderste/Inner			4	
5	5034716 Højre/Right/Rechs (*) Styrekugle/Tie rod end/Kugelgelenk	14x1,5 RHT Yderste/Outer/Außen			5	
6	5034735 Venstre/Left/Links (*) Styrekugle/Tie rod end/Kugelgelenk	14x1,5 RHT Yderste/Outer/Außen			6	
7	5034759 Venstre/Left/Links (**) Styrekugle/Tie rod end/Kugelgelenk	14x1,5 RHT Yderste/Outer/Außen			7	
8	5034760 Højre/Right/Rechs (**) Styrekugle/Tie rod end/Kugelgelenk	14x1,5 RHT Yderste/Outer/Außen			8	
9	5034762 V/H - L/R (**) Styrekugle/Tie rod end/Axialgelenk	14x1,5 RHT Inderste/Inner			9	
10	5044731 Venstre/Left/Links Bærekugle/Ball joint/Radgelenk	Nederste/Lower/Unten			10	
11	5044732 Højre/Right/Rechs Bærekugle/Ball joint/Radgelenk	Nederste/Lower/Unten			11	
						(*) Uden servostyring Without Power Steering Ohne Servolenkung
						(**) Med servostyring With Power Steering Mit Servolenkung
POS						
12	5094708 (**) Manchetsæt/Boot kit/Manschetten satz				12	
13	5102314 Bag/Rear/Hinten Bøsning/Bushing/Buchsen	V/H - L/R			13	
14	5102315 For/Front/Vorne Bøsning/Bushing/Buchsen	V/H - L/R			14	
15	5112304 V/H - L/R Ø15mm. 75 mm. Stabilisator/Stabilizer/Stabilisator				15	
16	5112312 V/H - L/R Ø18mm. 75 mm. Stabilisator bolt/Stabilizer bolt/Stabilisator bolzen				16	

VOLKSWAGEN

POS	 Polo (9N_) 10/01-				
Foraksel/Front axle/Vorneachse					
1	5014302 V/H - L/R Bærearmlenker/Track control arm/Querlenker	Nederste/Lower/Unten			1
2	5034307 Venstre/Left/Links Styrekugle/Tie rod end/Kugelgelenk	14X1,5 RHT Yderste/Outer/Außen			2
3	5034308 Højre/Right/Rechs Styrekugle/Tie rod end/Kugelgelenk	14X1,5 RHT Yderste/Outer/Außen			3
4	5034309 V/H - L/R Styrekugle/Tie rod end/Axialgelenk	14X1,5 RHT Inderste/Inner			4
5	5044303 Venstre/Left/Links Bærekugle/Ball joint/Radgelenk	Nederste/Lower/Unten			5
6	5044304 Højre/Right/Rechs Bærekugle/Ball joint/Radgelenk	Nederste/Lower/Unten			6
7	5104301 For/Front/Vorne Bøsning/Bushing/Buchsen	V/H - L/R			7
8	5104302 Bag/Rear/Hinten Bøsning/Bushing/Buchsen	V/H - L/R			8
9	5111510 V/H - L/R 270 mm. Stabilisator/Stabilizer/Stabilisator				9
POS  Scirocco (53) 2/74-12/83 & Scirocco (53B) 3/81-7/92					
Foraksel/Front axle/Vorneachse					
1	5004710 V/H - L/R Styrestang/Steering rod/Spurstange			1	
2	5014703 V/H - L/R Bærearmlenker/Track control arm/Querlenker	Nederste/Lower/Unten			2
3	5034714 V/H - L/R Styrekugle/Tie rod end/Kugelgelenk	14x1,5 RHT Yderste/Outer/Außen			3
4	5034715 V/H - L/R (*) Styrekugle/Tie rod end/Axialgelenk	14x1,5 RHT Inderste/Inner			4
5	5044708 V/H - L/R CH. 538 2028 903- Bærekugle/Ball joint/Radgelenk	Konus/Cone 17mm. Nederste/Lower/Unten			5
6	5044709 V/H - L/R CH. - 538 2028 902 Bærekugle/Ball joint/Radgelenk	Konus/Cone 15mm. Nederste/Lower/Unten			6
7	5092313 ZF (53B) (**) Manchetsæt/Boot kit/Manschetten satz				7
8	5094703 -53 Manchetsæt/Boot kit/Manschetten satz			8	
9	5094704 (53B) (*) Manchetsæt/Boot kit/Manschetten satz			9	
10	5104734 Bag/Rear/Hinten Bøsning/Bushing/Buchsen	V/H - L/R			10
11	5104735 For/Front/Vorne Bøsning/Bushing/Buchsen	V/H - L/R			11
					(*) Uden servostyring Without Power Steering Ohne Servolenkung
					(**) Med servostyring With Power Steering Mit Servolenkung

POS	 Sharan (7M) 5/95-			
Foraksel/Front axle/Vorneachse				
1	5002503 Venstre/Left/Links Styrestang/Steering rod/Spurstange		1	
2	5002504 Højre/Right/Rechs Styrestang/Steering rod/Spurstange		2	
3	5012533 Venstre/Left/Links Bærearmlenke/Track control arm/Querlenker	Nederste/Lower/Unten		
4	5012534 Højre/Right/Rechs Bærearmlenke/Track control arm/Querlenker	Nederste/Lower/Unten		
5	5032541 Venstre/Left/Links Styrekugle/Tie rod end/Kugelgelenk	14x1,5 RHT Yderste/Outer/Außen		
6	5032542 Højre/Right/Rechs Styrekugle/Tie rod end/Kugelgelenk	14x1,5 RHT Yderste/Outer/Außen		
7	5032543 V/H - L/R Styrekugle/Tie rod end/Axialgelenk	14x1,5 RHT Inderste/Inner		
8	5044733 V/H - L/R Bærekugle/Ball joint/Radgelenk	Nederste/Lower/Unten		
9	5092316 Manchetsæt/Boot kit/Manschetten satz			
10	5102514 Bag/Rear/Hinten V/H - L/R Bøsning/Bushing/Buchsen			
POS				
11	5102515 For/Front/Vorne V/H - L/R Bøsning/Bushing/Buchsen			
12	5112303 V/H - L/R 205 mm. Stabilisatorstang/Stabilizer rod/Diagonalstrebe			

POS	 Taro 4/89-3/97			
Foraksel/Front axle/Vorneachse				
1	5004502 V/H - L/R 2WD Styrestang/Steering rod/Spurstange			 1
2	5034526 V/H - L/R Styrekugle/Tie rod end/Kugelgelenk	17x1,5 Yderste/Outer/Außen		 2
3	5044532 V/H - L/R 2WD Bærekugle/Ball joint/Radgelenk	Nederste/Lower/Unten		 3
4	5044533 V/H - L/R 4WD Bærekugle/Ball joint/Radgelenk	Øverste/Upper/Oben		 4
5	5044534 V/H - L/R 4WD Bærekugle/Ball joint/Radgelenk	Nederste/Lower/Unten		 5
POS  Touareg 10/02-				
Foraksel/Front axle/Vorneachse				
1	5014741 Venstre/Left/Links Bærearm/Track control arm/Querlenker			 1
2	5014742 Højre/Right/Rechs Bærearm/Track control arm/Querlenker			
3	5034777 Venstre/Left/Links Styrekugle/Tie rod end/Kugelgelenk	Yderste/Outer/Außen		 3
4	5034778 Højre/Right/Rechs Styrekugle/Tie rod end/Kugelgelenk	Yderste/Outer/Außen		 4
5	5034779 V/H - L/R Styrekugle/Tie rod end/Axialgelenk	Inderste/Inner		 5
6	5114729 V/H - L/R 197 mm. Stabilisatorstang/Stabilizer rod/Diagonalstrebe			 6
Bagaksel/Rear axle/Hinterachse				
7	5114730 Venstre/Left/Links 200 mm. Stabilisatorstang/Stabilizer rod/Diagonalstrebe			 7
8	5114731 Højre/Right/Rechs 200 mm. Stabilisatorstang/Stabilizer rod/Diagonalstrebe			 8

POS	 Touran 2/03-			
Foraksel/Front axle/Vorneachse				
1	5014743 Venstre/Left/Links Bærearmlenke/Track control arm/Querlenker	(- Diesel) Nederste/Lower/Unten		
2	5014744 Højre/Right/Rechs Bærearmlenke/Track control arm/Querlenker	(- Diesel) Nederste/Lower/Unten		
3	5014745 Venstre/Left/Links Bærearmlenke/Track control arm/Querlenker	(Diesel) Nederste/Lower/Unten		
4	5014746 Højre/Right/Rechs Bærearmlenke/Track control arm/Querlenker	(Diesel) Nederste/Lower/Unten		
5	5034780 V/H - L/R Styrekugle/Tie rod end/Axialgelenk	810 mm. 16x1,5 RHT		
6	5034781 Venstre/Left/Links Styrekugle/Tie rod end/Kugelgelenk	16x1,5 RHT		
7	5034782 Højre/Right/Rechs Styrekugle/Tie rod end/Kugelgelenk	16x1,5 RHT		
8	5044743 Venstre/Left/Links Bærekugle/Ball joint/Radgelenk	Nederste/Lower/Unten		
9	5044744 Højre/Right/Rechs Bærekugle/Ball joint/Radgelenk	Nederste/Lower/Unten		
10	5104737 Bag/Rear/Hinten Bøsning/Bushing/Buchsen	Venstre/Left/Links Nederste/Lower/Unten		
POS 				
11	5104738 Bag/Rear/Hinten Bøsning/Bushing/Buchsen	Højre/Right/Rechs Nederste/Lower/Unten		
12	5104739 For/Front/Vorne Bøsning/Bushing/Buchsen	V/H - L/R Nederste/Lower/Unten		
13	5114723 V/H - L/R 335 mm. Stabilisatorstang/Stabilizer rod/Diagonalstrebe			
Bagaksel/Rear axle/Hinterachse				
14	5114733 V/H - L/R 95 mm. Stabilisator bolt/Stabilizer bolt/Stabilisator bolzen			











POS	Transporter Type II 8/67-7/79			
Foraksel/Front axle/Vorneachse				
1	5034709 V/H - L/R Styrekugle/Tie rod end/Kugelgelenk	14x1,5 RHT Konus/Cone 14,0mm. Yderste/Outer/Außen		1
2	5034710 U V/H - L/R Styrekugle/Tie rod end/Axialgelenk	14x1,5 LHT Konus/Cone 14,0mm. Inderste/Inner		
POS	Transporter Type III 5/79-7/92			
Foraksel/Front axle/Vorneachse				
1	5004719 V/H - L/R Styrestang/Steering rod/Spurstange			1
2	5024710 (*) Tandstang/Steering rack/Zahnstange			2
3	5034714 V/H - L/R Styrekugle/Tie rod end/Kugelgelenk	14x1,5 RHT Yderste/Outer/Außen		3
4	5044714 V/H - L/R Bærekugle/Ball joint/Radgelenk	Øverste/Upper/Oben		4
5	5044715 V/H - L/R Bærekugle/Ball joint/Radgelenk	Udvendig/Outer/Außen48,3 mm. Nederste/Lower/Unten		5
6	5094706 Manchetsæt/Boot kit/Manschetten satz			6
7	5104710 Bag/Rear/Hinten Indvendig/Inner/Innen26 mm. Bøsning/Bushing/Buchsen	V/H - L/R Udvendig/Outer/Außen66 mm. Nederste/Lower/Unten		7
8	5104711 For/Front/Vorne Indvendig/Inner/Innen26 mm. Bøsning/Bushing/Buchsen	V/H - L/R Udvendig/Outer/Außen66 mm. Nederste/Lower/Unten		8
9	5104723 V/H - L/R Bøsning/Bushing/Buchsen	Øverste/Upper/Oben		9
				(*) Uden servostyring Without Power Steering Ohne Servolenkung

VOLKSWAGEN





POS	Transporter T4 7/90-12/95			
Foraksel/Front axle/Vorneachse				
1	5004739 Venstre/Left/Links 9/91 - 8/94 (*) Konus/Cone 16mm. Styrestang/Steering rod/Spurstange		1	
2	5004740 Højre/Right/Rechs 9/91 - 8/94 Konus/Cone 16mm. Styrestang/Steering rod/Spurstange		2	
3	5004741 Venstre/Left/Links 9/91 - 8/94 (**) Konus/Cone 16mm. Styrestang/Steering rod/Spurstange		3	
4	5004766 Venstre/Left/Links - 8/91 (*) Konus/Cone 14mm. Styrestang/Steering rod/Spurstange		4	
5	5004767 Højre/Right/Rechs - 8/91 (*) Konus/Cone 14mm. Styrestang/Steering rod/Spurstange		5	
6	5004768 Venstre/Left/Links - 8/91 (**) Konus/Cone 14mm. Styrestang/Steering rod/Spurstange		6	
7	5004769 Venstre/Left/Links 9/94 - 12/95 (*) Konus/Cone 18mm. Styrestang/Steering rod/Spurstange		7	
8	5004770 Højre/Right/Rechs 9/94 - 12/95 Konus/Cone 18mm. Styrestang/Steering rod/Spurstange		8	
9	5004771 Venstre/Left/Links 9/94 - 12/95 (**) Konus/Cone 18mm. Styrestang/Steering rod/Spurstange		9	
10	5034738 Venstre/Left/Links 9/91 - 8/94 16x1,5 RHT Konus/Cone 16mm. Styrekugle/Tie rod end/Kugelgelenk Yderste/Outer/Außen		10	
				(⁻) Uden servostyring Without Power Steering Ohne Servolenkung
				(^{**}) Med servostyring With Power Steering Mit Servolenkung
POS				
11	5034739 Højre/Right/Rechs 9/91 - 8/94 16x1,5 RHT Konus/Cone 16mm. Styrekugle/Tie rod end/Kugelgelenk Yderste/Outer/Außen		11	
12	5034740 Venstre/Left/Links (*) 14x1,5 RHT Styrekugle/Tie rod end/Axialgelenk Inderste/Inner		12	
13	5034741 Venstre/Left/Links (**) 14x1,5 RHT Styrekugle/Tie rod end/Axialgelenk Inderste/Inner		13	
14	5034741 Højre/Right/Rechs 14x1,5 RHT Styrekugle/Tie rod end/Axialgelenk Inderste/Inner		14	
15	5034749 Venstre/Left/Links - 8/91 16x1,5 RHT Konus/Cone 14mm. Styrekugle/Tie rod end/Kugelgelenk Yderste/Outer/Außen		15	
16	5034750 Højre/Right/Rechs 16x1,5 RHT Konus/Cone 14mm. Styrekugle/Tie rod end/Kugelgelenk Yderste/Outer/Außen		16	
17	5034751 Venstre/Left/Links 9/94 - 12/95 16x1,5 RHT Konus/Cone 18mm. Styrekugle/Tie rod end/Kugelgelenk Yderste/Outer/Außen		17	
18	5034752 Højre/Right/Rechs 9/94 - 12/95 16x1,5 RHT Konus/Cone 18mm. Styrekugle/Tie rod end/Kugelgelenk Yderste/Outer/Außen		18	
19	5044725 V/H - L/R Bærekugle/Ball joint/Radgelenk Øverste/Upper/Oben		19	
20	5044726 V/H - L/R Bærekugle/Ball joint/Radgelenk Nederste/Lower/Unten		20	

POS	Transporter T4 7/90-12/95			
Foraksel/Front axle/Vorneachse				
21	5094713 Ø25/46 mm. 120 mm. Manchetsæt/Boot kit/Manschetten satz			21
22	5104730 V/H - L/R Bøsning/Bushing/Buchsen			22
23	5104732 V/H - L/R Bøsning/Bushing/Buchsen			23
24	5114701 V/H - L/R (-Syncro) Ø14/23 mm. 109 mm. Stabilisatorstang/Stabilizer rod/Diagonalstrebe			24
25	5114734 V/H - L/R (-Syncro) Ø14mm. 107 mm. Stabilisatorstang/Stabilizer rod/Diagonalstrebe			25
26	xxxxxx Venstre/Left/Links Bæream/Track control arm/Querlenker			
27	xxxxxx Højre/Right/Rechs Bæream/Track control arm/Querlenker			
POS	Transporter T4 1/96-			
Foraksel/Front axle/Vorneachse				
1	5004783 Venstre/Left/Links Styrestang/Steering rod/Spurstange			1
2	5004784 Højre/Right/Rechs Styrestang/Steering rod/Spurstange			2
3	5034741 V/H - L/R (**) Styrekugle/Tie rod end/Axialgelenk	14x1,5 RHT Inderste/Inner		3
4	5034767 Venstre/Left/Links Styrekugle/Tie rod end/Kugelgelenk	16x1,5 RHT Konus/Cone 18,0mm. Yderste/Outer/Außen		4
5	5034768 Højre/Right/Rechs Styrekugle/Tie rod end/Kugelgelenk	16x1,5 RHT Konus/Cone 18,0mm. Yderste/Outer/Außen		5
6	5044725 V/H - L/R Bærekugle/Ball joint/Radgelenk	Øverste/Upper/Oben		6
7	5044742 V/H - L/R Bærekugle/Ball joint/Radgelenk	Nederste/Lower/Unten		7
8	5094714 Ø25/54 mm. 126 mm. Manchetsæt/Boot kit/Manschetten satz			8
9	5104731 For/Front/Vorne Bøsning/Bushing/Buchsen	V/H - L/R		9
10	5104732 Bag/Rear/Hinten Bøsning/Bushing/Buchsen	V/H - L/R		10
			(**) Med servostyring With Power Steering Mit Servolenkung	







VOLKSWAGEN

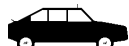





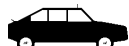











POS	 Transporter T4 1/96-			
11	5114701 V/H - L/R (-Syncro) Stabilisatorstang/Stabilizer rod/Diagonalstrebe	Ø14/23 mm. 109 mm.		11
12	5114734 V/H - L/R (Syncro) Stabilisatorstang/Stabilizer rod/Diagonalstrebe	Ø14mm. 107 mm.		12
13	xxxxxx Venstre/Left/Links Bærearml/Track control arm/Querlenker			
14	xxxxxx Højre/Right/Rechs Bærearml/Track control arm/Querlenker			
POS	 Transporter T5 4/03-			
	Foraksel/Front axle/Vorneachse			
1	5034783 Venstre/Left/Links Styrekugle/Tie rod end/Kugelgelenk	16x1,5 RHT Konus/Cone 20mm. Yderste/Outer/Außen		1
2	5034784 Højre/Right/Rechs Styrekugle/Tie rod end/Kugelgelenk	16x1,5 RHT Konus/Cone 20mm. Yderste/Outer/Außen		2
3	5034785 V/H - L/R Styrekugle/Tie rod end/Axialgelenk	177 mm. 16x1,5 Inderste/Inner		3
4	5044745 V/H - L/R Bærekugle/Ball joint/Radgelenk	(2,6T & 3.0T) Nederste/Lower/Unten		4
5	5044746 V/H - L/R Bærekugle/Ball joint/Radgelenk	(3,2T) Nederste/Lower/Unten		
6	5114735 V/H - L/R Stabilisatorstang/Stabilizer rod/Diagonalstrebe	Ø9mm. 262 mm.		6
7	5114751 V/H - L/R HD Stabilisatorstang/Stabilizer rod/Diagonalstrebe	Ø10mm. 262 mm.		







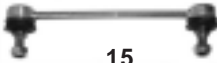







POS	Vento 11/91-9/98				
		Foraksel/Front axle/Vorneachse			
1	5004734 Venstre/Left/Links (*) Styrestang/Steering rod/Spurstange				1
2	5004735 Højre/Right/Rechs (*) Styrestang/Steering rod/Spurstange				2
3	5004754 Venstre/Left/Links Styrestang/Steering rod/Spurstange	ZF (**)	RHT		3
4	5004755 Højre/Right/Rechs Styrestang/Steering rod/Spurstange	ZF (**)	LHT		4
5	5004756 Venstre/Left/Links Styrestang/Steering rod/Spurstange	TRW (**)	400 mm. RHT		5
6	5004757 Højre/Right/Rechs Styrestang/Steering rod/Spurstange	TRW (**)	400 mm. LHT		6
7	5014725 V/H - L/R Bærearmlenke/Track control arm/Querlenker	(-VR6/16V)	Nederste/Lower/Unten		7
8	5014739 Venstre/Left/Links Bærearmlenke/Track control arm/Querlenker	(VR6/16V)	Nederste/Lower/Unten		8
9	5014740 Højre/Right/Rechs Bærearmlenke/Track control arm/Querlenker	(VR6/16V)	Nederste/Lower/Unten		9
10	5034716 Højre/Right/Rechs Styrekugle/Tie rod end/Kugelgelenk	14x1,5 RHT	Yderste/Outer/Außen		10
					(*) Uden servostyring Without Power Steering Ohne Servolenkung
					(**) Med servostyring With Power Steering Mit Servolenkung
POS					
11	5034734 V/H - L/R (*) Styrekugle/Tie rod end/Axialgelenk	22x1,5 RHT	Inderste/Inner		11
12	5034735 Venstre/Left/Links Styrekugle/Tie rod end/Kugelgelenk	14x1,5 RHT	Yderste/Outer/Außen		12
13	5034746 V/H - L/R ZF (**) Styrekugle/Tie rod end/Axialgelenk	14x1,5 RHT	Inderste/Inner		13
14	5044720 V/H - L/R (-VR6/16V) Bærekugle/Ball joint/Radgelenk	Konus/Cone 19mm.	Nederste/Lower/Unten		14
15	5044734 V/H - L/R (VR6/16V) Bærekugle/Ball joint/Radgelenk	Konus/Cone 18mm.	Nederste/Lower/Unten		15
16	5094704 (*) Manchetsæt/Boot kit/Manschetten satz				16
17	5094715 TRW (**) Manchetsæt/Boot kit/Manschetten satz				17
18	5104705 Bag/Rear/Hinten Bøsning/Bushing/Buchsen	V/H - L/R			18
19	5104720 For/Front/Vorne Bøsning/Bushing/Buchsen	V/H - L/R			19
20	5104799 Bag/Rear/Hinten	V/H - L/R			20







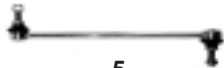





POS	 Vento 11/91-9/98
	Bøsning/Bushing/Buchsen
21	<p>5112305 V/H - L/R (-VR6) Ø17mm. 75 mm.  21</p> <p>Stabilisator/Stabilizer/Stabilisator</p>
	Bagaksel/Rear axle/Hinterachse
22	<p>5104726 V/H - L/R  22</p> <p>Bøsningssæt/Bushing set/Buchsen satz</p>
POS	

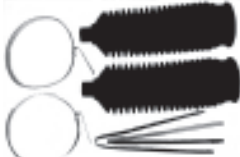
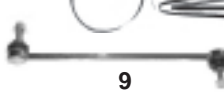





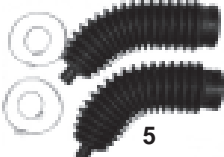
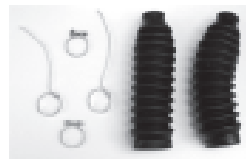





POS	
POS	

POS	 Amazone 121/122 1959-70		
Foraksel/Front axle/Vorneachse			
1	5004803 U Venstre/Left/Links Styrestang/Steering rod/Spurstange		
2	5004804 U Højre/Right/Rechs Styrestang/Steering rod/Spurstange		1
3	5044803 U V/H - L/R 8/65 - Bærekugle/Ball joint/Radgelenk	Øverste/Upper/Oben	
4	5044804 V/H - L/R Bærekugle/Ball joint/Radgelenk	Nederste/Lower/Unten	2
			
			3
			
			4
POS	 C-30 10/06-		
Foraksel/Front axle/Vorneachse			
1	5032567 Venstre/Left/Links Styrekugle/Tie rod end/Kugelgelenk	Yderste/Outer/Außen	
2	5032568 Højre/Right/Rechs Styrekugle/Tie rod end/Kugelgelenk	Yderste/Outer/Außen	

POS	 S40 (VS) 7/95- & V40 (VW) 7/95-			
Foraksel/Front axle/Vorneachse				
1	5014807 Venstre/Left/Links Bærearmlenke/Track control arm/Querlenker	- 7/00	Nederste/Lower/Unten	
2	5014808 Højre/Right/Rechs Bærearmlenke/Track control arm/Querlenker	- 7/00	Nederste/Lower/Unten	
3	5014813 Venstre/Left/Links Bærearmlenke/Track control arm/Querlenker	7/00 -	Nederste/Lower/Unten	
4	5014814 Højre/Right/Rechs Bærearmlenke/Track control arm/Querlenker	7/00 -	Nederste/Lower/Unten	
5	5034820 V/H - L/R - 7/00 Styrekugle/Tie rod end/Kugelgelenk	12x1,25 RHT	Yderste/Outer/Außen	
6	5034821 V/H - L/R - 7/00 Styrekugle/Tie rod end/Axialgelenk		Inderste/Inner	
7	5034826 V/H - L/R 7/00 - Styrekugle/Tie rod end/Axialgelenk		Inderste/Inner	
8	5034827 Venstre/Left/Links Styrekugle/Tie rod end/Kugelgelenk	7/00 - 12x1,25	Yderste/Outer/Außen	
9	5034828 Højre/Right/Rechs Styrekugle/Tie rod end/Kugelgelenk	7/00 - 12x1,25	Yderste/Outer/Außen	
10	5043009 V/H - L/R Ø15mm. Bærekugle/Ball joint/Radgelenk		Nederste/Lower/Unten	
POS 				
11	5093001 Manchetsæt/Boot kit/Manschetten satz			
12	5104820 For/Front/Vorne Bøsning/Bushing/Buchsen	Venstre/Left/Links	Nederste/Lower/Unten	
13	5104821 For/Front/Vorne Bøsning/Bushing/Buchsen	Højre/Right/Rechs	Nederste/Lower/Unten	
14	5104822 Bag/Rear/Hinten Bøsning/Bushing/Buchsen	V/H - L/R	Nederste/Lower/Unten	
15	5114804 V/H - L/R - 7/00 Stabilisatorstang/Stabilizer rod/Diagonalstrebe	200 mm.		
16	5114814 V/H - L/R 7/00 - Stabilisatorstang/Stabilizer rod/Diagonalstrebe			
Bagaksel/Rear axle/Hinterachse				
17	5114805 V/H - L/R 105 mm. Stabilisator/Stabilizer/Stabilisator			

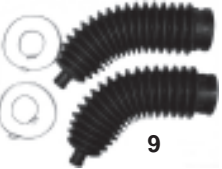
POS	 S40 II 4/04-			
Foraksel/Front axle/Vorneachse				
1	5032562 V/H - L/R Styrekugle/Tie rod end/Axialgelenk	Inderste/Inner		
2	5032567 Venstre/Left/Links Styrekugle/Tie rod end/Kugelgelenk	Yderste/Outer/Außen		
3	5032568 Højre/Right/Rechs Styrekugle/Tie rod end/Kugelgelenk	Yderste/Outer/Außen		
4	5042525 V/H - L/R Bærekugle/Ball joint/Radgelenk	Konus/Cone 18mm. Nederste/Lower/Unten		
5	5114809 V/H - L/R Stabilisatorstang/Stabilizer rod/Diagonalstrebe	300 mm.		
Bagaksel/Rear axle/Hinterachse				
6	5012552 V/H - L/R Bærearmlenke/Track control arm/Querlenker	Nederste/Lower/Unten		
<hr/>				
POS	 V50 4/04-			
Foraksel/Front axle/Vorneachse				
1	5032562 V/H - L/R Styrekugle/Tie rod end/Axialgelenk	Inderste/Inner		
2	5032567 Venstre/Left/Links Styrekugle/Tie rod end/Kugelgelenk	Yderste/Outer/Außen		
3	5032568 Højre/Right/Rechs Styrekugle/Tie rod end/Kugelgelenk	Yderste/Outer/Außen		
4	5042525 V/H - L/R Bærekugle/Ball joint/Radgelenk	Konus/Cone 18mm. Nederste/Lower/Unten		
5	5114809 V/H - L/R Stabilisatorstang/Stabilizer rod/Diagonalstrebe	300 mm.		
Bagaksel/Rear axle/Hinterachse				
6	5012552 V/H - L/R Bærearmlenke/Track control arm/Querlenker	Nederste/Lower/Unten		















POS	S60 11/00-			
Foraksel/Front axle/Vorneachse				
1	5014815 Venstre/Left/Links Bærearmlenke/Track control arm/Querlenker	Nederste/Lower/Unten		
2	5014816 Højre/Right/Rechs Bærearmlenke/Track control arm/Querlenker	Nederste/Lower/Unten		
3	5034822 V/H - L/R Styrekugle/Tie rod end/Axialgelenk	14x1,5 RHT Inderste/Inner		
4	5034823 Venstre/Left/Links Styrekugle/Tie rod end/Kugelgelenk	14x1,5 RHT Yderste/Outer/Außen		
5	5034824 Højre/Right/Rechs Styrekugle/Tie rod end/Kugelgelenk	14x1,5 RHT Yderste/Outer/Außen		
6	5044813 V/H - L/R Bærekugle/Ball joint/Radgelenk	Nederste/Lower/Unten		
7	5094807 Manchetsæt/Boot kit/Manschetten satz			
8	5094808 TRW Manchetsæt/Boot kit/Manschetten satz			
9	5114810 V/H - L/R 335 mm. Stabilisatorstang/Stabilizer rod/Diagonalstrebe			
Bagaksel/Rear axle/Hinterachse				
10	5114811 V/H - L/R 143 mm. Stabilisatorstang/Stabilizer rod/Diagonalstrebe			
POS	S80 6/98-			
Foraksel/Front axle/Vorneachse				
1	5034822 V/H - L/R Styrekugle/Tie rod end/Axialgelenk	14x1,5 RHT Inderste/Inner		
2	5034823 Venstre/Left/Links Styrekugle/Tie rod end/Kugelgelenk	14x1,5 RHT Yderste/Outer/Außen		
3	5034824 Højre/Right/Rechs Styrekugle/Tie rod end/Kugelgelenk	14x1,5 RHT Yderste/Outer/Außen		
4	5044813 V/H - L/R Bærekugle/Ball joint/Radgelenk	Nederste/Lower/Unten		
5	5094807 Manchetsæt/Boot kit/Manschetten satz			
6	5094808 TRW Manchetsæt/Boot kit/Manschetten satz			
7	5114810 V/H - L/R 335 mm. Stabilisatorstang/Stabilizer rod/Diagonalstrebe			
Bagaksel/Rear axle/Hinterachse				
8	5114811 V/H - L/R 143 mm. Stabilisatorstang/Stabilizer rod/Diagonalstrebe			

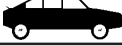















POS	 C70/S70 1/97- & V70 I 1/97-3/00			
Foraksel/Front axle/Vorneachse				
1	5014809 Venstre/Left/Links Bæream/Track control arm/Querlenker	(-Turbo) Nederste/Lower/Unten		
2	5014810 Højre/Right/Rechs Bæream/Track control arm/Querlenker	(-Turbo) Nederste/Lower/Unten		
3	5014811 Venstre/Left/Links Bæream/Track control arm/Querlenker	(Turbo) Nederste/Lower/Unten		
4	5014812 Højre/Right/Rechs Bæream/Track control arm/Querlenker	(Turbo) Nederste/Lower/Unten		
5	5034817 Venstre/Left/Links Styrekugle/Tie rod end/Kugelgelenk	14x2 RHT Yderste/Outer/Außen		
6	5034818 Højre/Right/Rechs Styrekugle/Tie rod end/Kugelgelenk	14x2 RHT Yderste/Outer/Außen		
7	5034819 V/H - L/R TRW Styrekugle/Tie rod end/Axialgelenk	14x2 RHT Inderste/Inner		
8	5034829 V/H - L/R SMI Styrekugle/Tie rod end/Axialgelenk	14 x 1,5/16 x 1,5 RHT Inderste/Inner		
9	5094807 Manchetsæt/Boot kit/Manschetten satz			
10	5094808 TRW Manchetsæt/Boot kit/Manschetten satz			
POS				
11	5104819 Bøsningssæt/Bushing set/Buchsen satz			
12	5114806 V/H - L/R 303 mm. Stabilisatorstang/Stabilizer rod/Diagonalstrebe			



POS	V70 II 3/00-
Foraksel/Front axle/Vorneachse	
1	5014815 Venstre/Left/Links Bærearmlenke/Track control arm/Querlenker Nederste/Lower/Unten
2	5014816 Højre/Right/Rechs Bærearmlenke/Track control arm/Querlenker Nederste/Lower/Unten
3	5034822 V/H - L/R Styrekugle/Tie rod end/Axialgelenk 14x1,5 RHT Inderste/Inner
4	5034823 Venstre/Left/Links Styrekugle/Tie rod end/Kugelgelenk 14x1,5 RHT Yderste/Outer/Außen
5	5034824 Højre/Right/Rechs Styrekugle/Tie rod end/Kugelgelenk 14x1,5 RHT Yderste/Outer/Außen
6	5044813 V/H - L/R Bærekugle/Ball joint/Radgelenk
7	5094807 Manchetsæt/Boot kit/Manschetten satz
8	5094808 TRW Manchetsæt/Boot kit/Manschetten satz
9	5114810 V/H - L/R 335 mm. Stabilisatorstang/Stabilizer rod/Diagonalstrebe
Bagaksel/Rear axle/Hinterachse	
10	5114811 V/H - L/R 143 mm. Stabilisatorstang/Stabilizer rod/Diagonalstrebe
POS	S90 1/97-12/98 & V90 1/97-12/98
Foraksel/Front axle/Vorneachse	
1	5034817 Venstre/Left/Links Styrekugle/Tie rod end/Kugelgelenk 14x2 RHT Yderste/Outer/Außen
2	5034818 Højre/Right/Rechs Styrekugle/Tie rod end/Kugelgelenk 14x2 RHT Yderste/Outer/Außen
3	5044811 V/H - L/R Bærekugle/Ball joint/Radgelenk Nederste/Lower/Unten
4	5114812 V/H - L/R Ø12mm. 244 mm. Stabilisatorstang/Stabilizer rod/Diagonalstrebe
Bagaksel/Rear axle/Hinterachse	
5	5114813 V/H - L/R Ø10mm. 64 mm. Stabilisator bolt/Stabilizer bolt/Stabilisator bolzen



POS	142/144/145/164 8/68-7/74			
Foraksel/Front axle/Vorneachse				
1	5004805 U Venstre/Left/Links Styrestang/Steering rod/Spurstange		1	
2	5004806 U Højre/Right/Rechs Styrestang/Steering rod/Spurstange		2	
3	5044805 U V/H - L/R 3/69 - Bærekugle/Ball joint/Radgelenk	Øverste/Upper/Oben		
4	5044807 U V/H - L/R Bærekugle/Ball joint/Radgelenk	Nederste/Lower/Unten		
Bagaksel/Rear axle/Hinterachse				
5	5104814 Højre/Right/Rechs Indvendig/Inner/Innen20 mm. Bøsning/Bushing/Buchsen	Udvendig/Outer/Außen40,5 mm.		
6	5104815 Venstre/Left/Links 1/74 - Bøsning/Bushing/Buchsen			
POS 240 Serie 8/74-8/93 & 260 Serie 8/74-8/93				
Foraksel/Front axle/Vorneachse				
1	5014804 U Højre/Right/Rechs Bærearmlenke/Track control arm/Querlenker	Nederste/Lower/Unten		
2	5014805 U Venstre/Left/Links Bærearmlenke/Track control arm/Querlenker	Nederste/Lower/Unten		
3	5024801 U - 5/86 Tandstang/Steering rack/Zahnstange			
4	5034805 V/H - L/R Styrekugle/Tie rod end/Kugelgelenk	14x2 RHT Yderste/Outer/Außen		
5	5034806 V/H - L/R ZF Styrekugle/Tie rod end/Axialgelenk	14x2/14x1,5 Inderste/Inner		
6	5034807 V/H - L/R CAM (*) Styrekugle/Tie rod end/Axialgelenk	14x2/14x1,5 Inderste/Inner		
7	5034811 V/H - L/R - 8/78 (**) Styrekugle/Tie rod end/Axialgelenk	14x2/20x1,5 Inderste/Inner		
8	5034812 V/H - L/R CAM (**) Styrekugle/Tie rod end/Axialgelenk	14x2/20x1,5 Inderste/Inner		
9	5044808 V/H - L/R (*) Bærekugle/Ball joint/Radgelenk	Nederste/Lower/Unten		
10	5044809 Venstre/Left/Links Bærekugle/Ball joint/Radgelenk	(**) Nederste/Lower/Unten		
				(*) Uden servostyring Without Power Steering Ohne Servolenkung
				(**) Med servostyring With Power Steering Mit Servolenkung

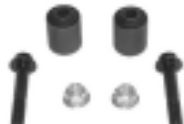
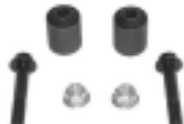
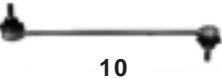

POS	240 Serie 8/74-8/93 & 260 Serie 8/74-8/93			
Foraksel/Front axle/Vorneachse				
11	5044810 Højre/Right/Rechs Bærekugle/Ball joint/Radgelenk	(**) Nederste/Lower/Unten		
12	5094801 U CAM - 8/78 (*) Manchetsæt/Boot kit/Manschetten satz			
13	5094802 U ZF - 8/78 (*) Manchetsæt/Boot kit/Manschetten satz			
14	5094803 U CAM - 8/78 (**) Manchetsæt/Boot kit/Manschetten satz			
15	5094804 U CAM 9/78 - (**) Manchetsæt/Boot kit/Manschetten satz			
16	5104806 Bag/Rear/Hinten V/H - L/R Bøsning/Bushing/Buchsen			
17	5104807 U For/Front/Vorne V/H - L/R Bøsning/Bushing/Buchsen			
18	5114801 V/H - L/R Ø11mm. 140 mm. Stabilisator bolt/Stabilizer bolt/Stabilisator bolzen			
Bagaksel/Rear axle/Hinterachse				
19	5014806 U V/H - L/R Bærearmlenke/Track control arm/Querlenker			
20	5104810 U Bag/Rear/Hinten V/H - L/R Bøsning/Bushing/Buchsen			
<p>(*) Uden servostyring Without Power Steering Ohne Servolenkung</p> <p>(**) Med servostyring With Power Steering Mit Servolenkung</p>				
POS				
21	5104811 U For/Front/Vorne V/H - L/R Bøsning/Bushing/Buchsen			
22	5104812 U V/H - L/R (242) CH. - 205100 Bøsning/Bushing/Buchsen			
22	5104812 U V/H - L/R (244) CH. - 675000 Bøsning/Bushing/Buchsen			
22	5104812 U V/H - L/R (245) CH. - 362900 Bøsning/Bushing/Buchsen			
22	5104812 U V/H - L/R (264) CH. - 122297 Bøsning/Bushing/Buchsen			
22	5104812 U V/H - L/R (265) CH. - 30464 Bøsning/Bushing/Buchsen			
23	5104813 V/H - L/R 1/81 - Bøsning/Bushing/Buchsen			
24	5104814 Højre/Right/Rechs Indvendig/Inner/Innen 20 mm. Bøsning/Bushing/Buchsen	Udvendig/Outer/Außen 40,5 mm.		
25	5104815 Venstre/Left/Links Bøsning/Bushing/Buchsen			

POS		340/360 1980-7/91 & 343/345 2/76-7/91				
Foraksel/Front axle/Vorneachse						
1	5034803	V/H - L/R	14x1,5 RHT	Konus/Cone 14,0mm. Yderste/Outer/Außen		
2	5034804 U	V/H - L/R (343/345)	14x1,5 RHT	Inderste/Inner	1	2
3	5034813 U	V/H - L/R (340/360)	14x1,5 RHT	Inderste/Inner		
4	5044802	V/H - L/R		Nederste/Lower/Unten	3	4
5	5094805 U			Manchetsæt/Boot kit/Manschetten satz		
6	5114802 U	V/H - L/R	CH. - 120999 170 mm.	Stabilisator bolt/Stabilizer bolt/Stabilisator bolzen		
6					5	
6					6	
POS		440/460 8/88-12/96 & 480 4/86-7/96				
Foraksel/Front axle/Vorneachse						
1	5034808	V/H - L/R	12x1,5 RHT	Yderste/Outer/Außen		
2	5034809	V/H - L/R (*)	12x1,5 RHT	Inderste/Inner	1	2
3	5034814	V/H - L/R (**)	12x1,5 RHT	Inderste/Inner		
4	5044812	V/H - L/R		Nederste/Lower/Unten	3	4
5	5094806	(**)		Manchetsæt/Boot kit/Manschetten satz		
6	5114807	Venstre/Left/Links	160 mm.	Stabilisatorstang/Stabilizer rod/Diagonalstrebe		
7	5114808	Højre/Right/Rechs	160 mm.	Stabilisatorstang/Stabilizer rod/Diagonalstrebe	6	7
Bagaksel/Rear axle/Hinterachse						
8	5114815	V/H - L/R	104 mm.	Stabilisatorstang/Stabilizer rod/Diagonalstrebe		8
					(*) Uden servostyring Without Power Steering Ohne Servolenkung	
					(**) Med servostyring With Power Steering Mit Servolenkung	







POS	740 Serie 4/84-7/92 & 760 Serie 8/82-7/92 & 780 Serie 8/86-7/90
Foraksel/Front axle/Vorneachse	
1	<p>5034805 V/H - L/R Styrekugle/Tie rod end/Kugelgelenk</p> <p>14x2 RHT Yderste/Outer/Außen</p> 
2	<p>5034815 V/H - L/R - 7/88 Styrekugle/Tie rod end/Axialgelenk</p> <p>14x2/18x1,5 RHT Inderste/Inner</p> 
3	<p>5034816 V/H - L/R 8/88 - Styrekugle/Tie rod end/Axialgelenk</p> <p>14x1,5 RHT Inderste/Inner</p> 
4	<p>5044811 V/H - L/R Bærekugle/Ball joint/Radgelenk</p> <p>Nederste/Lower/Unten</p> 
5	<p>5094804 U CAM Manchetsæt/Boot kit/Manschetten satz</p> 
6	<p>5104818 V/H - L/R Bøsning/Bushing/Buchsen</p> <p>Ø12mm. 140 mm.</p> 
7	<p>5114803 V/H - L/R Stabilisator bolt/Stabilizer bolt/Stabilisator bolzen</p> <p>Ø12mm. 140 mm.</p> 
Bagaksel/Rear axle/Hinterachse	
8	<p>5104814 Højre/Right/Rechs Indvendig/Inner/Innen20 mm. Bøsning/Bushing/Buchsen</p> <p>Udvendig/Outer/Außen40,5 mm.</p> 
9	<p>5104815 Venstre/Left/Links Bøsning/Bushing/Buchsen</p> 
POS	850 6/91-12/96
Foraksel/Front axle/Vorneachse	
1	<p>5014809 Venstre/Left/Links Bærearmlenke/Track control arm/Querlenker</p> <p>(-Turbo) Nederste/Lower/Unten</p> 
2	<p>5014810 Højre/Right/Rechs Bærearmlenke/Track control arm/Querlenker</p> <p>(-Turbo) Nederste/Lower/Unten</p> 
3	<p>5014811 Venstre/Left/Links Bærearmlenke/Track control arm/Querlenker</p> <p>(Turbo) Nederste/Lower/Unten</p> 
4	<p>5014812 Højre/Right/Rechs Bærearmlenke/Track control arm/Querlenker</p> <p>(Turbo) Nederste/Lower/Unten</p> 
5	<p>5034817 Venstre/Left/Links Styrekugle/Tie rod end/Kugelgelenk</p> <p>14x2 RHT Yderste/Outer/Außen</p> 
6	<p>5034818 Højre/Right/Rechs Styrekugle/Tie rod end/Kugelgelenk</p> <p>14x2 RHT Yderste/Outer/Außen</p> 
7	<p>5034819 V/H - L/R TRW Styrekugle/Tie rod end/Axialgelenk</p> <p>14x2 RHT Inderste/Inner</p> 
8	<p>5034829 V/H - L/R SMI Styrekugle/Tie rod end/Axialgelenk</p> <p>14 x 1,5/16 x 1,5 RHT Inderste/Inner</p> 
9	<p>5104819 Bøsningssæt/Bushing set/Buchsen satz</p> 
10	<p>5114806 V/H - L/R 303 mm. Stabilisatorstang/Stabilizer rod/Diagonalstrebe</p> 

POS		940 Serie 8/90-10/98 & 960 Serie 8/90-12/96		
Foraksel/Front axle/Vorneachse				
1	5034805	V/H - L/R 14x2 RHT	Styrekugle/Tie rod end/Kugelgelenk	Yderste/Outer/Außen
2	5044811	V/H - L/R	Bærekugle/Ball joint/Radgelenk	Nederste/Lower/Unten
3	5104818	V/H - L/R	Bøsning/Bushing/Buchsen	
4	5114803	V/H - L/R (940 -12/96 & 960 -7/94)	Ø12mm. 140 mm.	Stabilisator bolt/Stabilizer bolt/Stabilisator bolzen
5	5114812	V/H - L/R (960) 8/94 -	Ø12mm. 244 mm.	Stabilisatorstang/Stabilizer rod/Diagonalstrebe
Bagaksel/Rear axle/Hinterachse				
6	5104814	Højre/Right/Rechs	Indvendig/Inner/Innen20 mm.	Udvendig/Outer/Außen40,5 mm.
7	5104815	Venstre/Left/Links	Bøsning/Bushing/Buchsen	
8	5114813	V/H - L/R (940/960) 8/94 -	Ø10mm. 64 mm.	Stabilisator bolt/Stabilizer bolt/Stabilisator bolzen
POS				

POS	
POS	

POS	
POS	



YUGO (ZASTAVA)

POS	 45 1985-95
	Foraksel/Front axle/Vorneachse
1	<p>5012303 V/H - L/R Bæream/Track control arm/Querlenker</p>  <p style="text-align: center;">1</p>
POS	 101 1972-93
	Foraksel/Front axle/Vorneachse
1	<p>5012303 V/H - L/R 4/78 - Bæream/Track control arm/Querlenker</p>  <p style="text-align: center;">1</p>
2	<p>5032309 V/H - L/R 14x1 RHT Styrekugle/Tie rod end/Kugelgelenk Yderste/Outer/Außen</p>  <p style="text-align: center;">2</p>
3	<p>5092301 Manchetsæt/Boot kit/Manschetten satz</p>  <p style="text-align: center;">3</p>

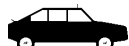
YUGO (ZASTAVA)



POS	
POS	

Anvendelsesliste
Buyer's guide
Nummerische Liste

NK Nr./No.			
5001001	Alfa Romeo	Alfa 145 1.4/1.6/1.7	10/94-1/01
5001002	Alfa Romeo	Alfa 145 1.4/1.6/1.7	10/94-1/01
5001003	Alfa Romeo	Alfa 147/156	11/97-
5001004	Alfa Romeo	Alfa 166	9/98-
5001005	Alfa Romeo	Alfa 147/156	11/97-
5001006	Alfa Romeo	Alfa 147/156	11/97-
5001503	BMW	3-Series (E30)	9/82-6/94
5001504	BMW	3-Series (E30)	9/82-6/94
5001505	BMW	5-Series (E12)	8/72-5/81
5001506	BMW	5-Series (E28)/ 6-Series (E24)	6/81-9/90
5001508	BMW	3-Series (E36)/Z3	9/90-
5001509	BMW	3-Series (E36)/Z3	9/90-
5001513	BMW	5-Series (E34)	1/88-1/97
5001514	BMW	3-Series (E36)	9/90-2/98
5001515	BMW	5-Series (E34)	1/88-1/97
5001516	BMW	5-Series (E28)&(E34)/ 6-Series (E24)/7-Series (E32)/ 8-Series (E31)	6/81-12/99
5001517	BMW	5-Series (E39)	11/95-
5001518	BMW	5-Series (E39)	11/95-
5001519	BMW	535i/540i/M5 E39	4/96-
5001520	BMW	730i, 740i, 750i E38	10/94-11/01
5001521	BMW	3-Series (E46)	3/98-
5001522	BMW	3-Series (E46)	3/98-
5002305	Lada	1200/1300/1500/1600	1972-1/87
5002503	Ford	Galaxy	11/95-
	Seat	Alhambra	4/96-
	Volkswagen	Sharan (7M)	5/95-
5002504	Ford	Galaxy	11/95-
	Seat	Alhambra	4/96-
	Volkswagen	Sharan (7M)	5/95-
5002505	Ford	Transit (T_) 130-190 & 100L	10/85-9/92
5002506	Ford	Transit (T_) 130-190 & 100L	10/85-9/92
5002507	Ford	Transit (T_) 130-190 & 100L	10/85-9/92
5002508	Ford	Transit (T_) 130-190 & 100L	10/85-9/92
5003303	MB	200/220/230/240/250/ 280/300 (C123&T123&W123)	1976-10/84
5003304	MB	200/220/230/240/250/ 280/300 (C123&T123&W123)	1976-10/84
5003307	MB	W201 190 D/E	10/82-8/93
5003309	MB	W124	11/84-3/98
5003310	MB	W124	11/84-6/93
5003311	MB	W201 190 D/E	10/82-8/93
5003312	MB	W201 190 D/E	10/82-8/93
5003316	MB	207D/208/209D/210/ 210D/309D/310D	
5003323	MB	W202	3/93-3/01
5003324	MB	W140	2/91-2/99
5003325	MB	W124	11/84-3/98



NK Nr./No.			
5003614	Opel	Commodore C/Monza/ Rekord E+Diesel/SenatorA	8/77-8/87
	Vauxhall	Carlton MK II/Senator	1978-8/87
5003615	Opel	Commodore C/Monza/ Rekord E+Diesel/Senator A	8/77-8/87
5003617	Opel	Omega A/Senator B	8/86-5/94
	Vauxhall	Carlton MK III/Senator MK II	8/86-3/94
5003619	Opel	Astra F/Calibra/Vectra A	9/88-
	Saab	900 II/9.3	7/93-
	Vauxhall	Astra MK III/Astravan MK III/ Cavalier MK III	9/88-8/98
5003620	Opel	Astra F/Calibra/Vectra A	9/88-
	Saab	900 II/9.3	7/93-
	Vauxhall	Astra MK III/Astravan MK III/ Cavalier MK III	9/88-8/98
5003623	Opel	Omega B	3/94-7/03
	Vauxhall	Omega B	3/94-
5003624	Opel	Omega B	3/94-7/03
	Vauxhall	Omega B	3/94-
5003625	Opel	Omega B	3/94-7/03
	Vauxhall	Omega B	3/94-
5003626	Daewoo	Espero/Lanos/Nexia	2/95-
	Opel	Ascona C/Kadett E	9/81-2/93
	Vauxhall	Cavalier MK II	9/81-10/88
5003627	Opel	Omega A/Senator B	8/86-5/94
	Vauxhall	Carlton MK III/Senator MK II	8/86-3/94
5003628	Opel	Omega A/Senator B	8/86-5/94
	Vauxhall	Carlton MK III/Senator MK II	8/86-3/94
5003629	Daewoo	Espero/Lanos/Nexia	2/95-
	Opel	Ascona C/Kadett E	9/81-2/93
	Vauxhall	Cavalier MK II	9/81-10/88
5003704	Peugeot	504	1/80-12/89
5003711	Peugeot	106 I & II (- XSi)	9/91-
5003712	Peugeot	106 I & II (- XSi)	9/91-
5003713	Peugeot	106 I & II Xsi	9/91-
5003714	Peugeot	106 I & II Xsi	9/91-
5004001	Jeep	Grand Cherokee 5.2	1/92-
5004002	Rover Group	Landrover Discovery I	9/89-9/98
5004003	Jeep	Wrangler	1/88-12/96
5004004	Jeep	Grand Cherokee 4.0	1/88-
5004502	Toyota	Hilux	8/78-8/88
	Volkswagen	Taro	4/89-3/97
5004706	Audi	50	1975-78
	Volkswagen	Derby (86)/Polo (86)	4/75-9/81
5004708	Volkswagen	Derby (86C)/Polo (86C)	8/81-8/94
5004709	Volkswagen	Derby (86C)/Polo (86C)	8/81-8/94
5004710	Volkswagen	Caddy I/Golf Cabrio I (155)/ Golf I (17)/Jetta I (17)/ Scirocco (53)&(53B)	2/74-8/93



Anvendelsesliste
Buyer's guide
Nummerische Liste

NK Nr./No.			
5004711	Seat	Cordoba/Ibiza/Toledo	3/91-10/02
	Volkswagen	Golf II (19E)/Jetta II (19E)	8/83-12/92
5004712	Seat	Cordoba/Ibiza/Toledo	3/91-10/02
	Volkswagen	Golf II (19E)/Jetta II (19E)	8/83-12/92
5004713	Audi	80 (- Aut.)	5/72-7/78
	Volkswagen	Passat (32/33)	7/73-7/80
5004714	Audi	80/90/Cabriolet/Coupe	4/80-
	Volkswagen	Passat (32B)/Santana	8/80-88
5004715	Audi	80/90/Coupe	4/80-9/91
	Volkswagen	Passat (32B)/Santana	8/80-88
5004719	Volkswagen	Transporter Type III	5/79-7/92
5004720	Volkswagen	LT 28/31/35	4/75-4/96
5004721	Volkswagen	LT 28/31/35	4/75-4/96
5004722	Volkswagen	LT 28/31/35	4/75-4/96
5004723	Volkswagen	LT 28/31/35	4/75-4/96
5004731	Audi	100/200	8/82-12/91
5004733	Audi	80/90/Coupe	8/80-10/88
	Volkswagen	Passat (32B)/Santana	8/80-88
5004734	Volkswagen	Golf III/Vento	11/91-4/99
5004735	Volkswagen	Golf III/Vento	11/91-4/99
5004736	Volkswagen	Passat (35I)	2/88-5/97
5004737	Volkswagen	Passat (35I)	2/88-5/97
5004739	Volkswagen	Transporter T4	7/90-12/95
5004740	Volkswagen	Transporter T4	7/90-12/95
5004741	Volkswagen	Transporter T4	7/90-12/95
5004743	Volkswagen	LT 40/45/50	8/78-5/96
5004744	Audi	80/Cabriolet/Coupe	9/86-
5004746	Audi	100/A6	12/90-12/97
5004747	Audi	100/A6	12/90-12/97
5004748	Seat	Arosa	5/97-
	Volkswagen	Polo (6N)/Polo Van (6NF)	10/94-
5004749	Seat	Arosa	5/97-
	Volkswagen	Polo (6N)/Polo Van (6NF)	10/94-
5004752	Seat	Cordoba/Ibiza/Toledo	3/91-10/02
	Volkswagen	Corrado (53I)/Golf II (19E)/ Jetta II (19E)	8/83-12/95
5004753	Seat	Cordoba/Ibiza/Toledo	3/91-10/02
	Volkswagen	Corrado (53I)/Golf II (19E)/ Jetta II (19E)	8/83-12/95
5004754	Volkswagen	Golf III/Vento	11/91-4/99
5004755	Volkswagen	Golf III/Vento	11/91-4/99
5004756	Volkswagen	Golf III/Vento	11/91-4/99
5004757	Volkswagen	Golf III/Vento	11/91-4/99
5004758	Volkswagen	Passat (32B)	8/80-88
5004759	Volkswagen	Passat (35I)	2/88-5/97
5004760	Volkswagen	Passat (35I)	2/88-5/97
5004765	Volkswagen	Passat (35I)	2/88-5/97
5004766	Volkswagen	Transporter T4	7/90-12/95
5004767	Volkswagen	Transporter T4	7/90-12/95
5004768	Volkswagen	Transporter T4	7/90-12/95

NK Nr./No.			
5004769	Volkswagen	Transporter T4	7/90-12/95
5004770	Volkswagen	Transporter T4	7/90-12/95
5004771	Volkswagen	Transporter T4	7/90-12/95
5004772	Audi	A3 (8L1)	6/96-
	Seat	Ibiza/Toledo II	4/99-
	Skoda	Octavia (1U2 & 1U5)	9/96-
	Volkswagen	Bora/Golf IV/New Beetle	8/97-
5004773	Audi	A3 (8L1)	6/96-
	Seat	Ibiza/Toledo II	4/99-
	Skoda	Octavia (1U2 & 1U5)	9/96-
	Volkswagen	Bora/Golf IV/New Beetle	8/97-
5004774	Audi	A4/A6/A8	3/94-
	Volkswagen	Passat	8/96-
	Skoda	Superb	2/02-
5004775	Volkswagen	Polo	10/94-9/01
5004776	Volkswagen	Polo	10/94-9/01
5004777	Volkswagen	Sharan (7M)	5/95-
5004778	Volkswagen	Sharan (7M)	5/95-
5004779	Seat	Cordoba/Ibiza/Inca/Toledo	3/91-
	Volkswagen	Caddy II	11/95-
5004780	Seat	Cordoba/Ibiza/Inca/Toledo	3/91-
	Volkswagen	Caddy II	11/95-
5004781	Audi	A6 (4A, C4)	6/94-12/97
5004783	Volkswagen	Transporter T4	1/96-
5004784	Volkswagen	Transporter T4	1/96-
5004803	Volvo	Amazone 121/122	1959-70
5004804	Volvo	Amazone 121/122	1959-70
5004805	Volvo	142/144/145/164	8/68-7/74
5004806	Volvo	142/144/145/164	8/68-7/74
5011001	Alfa Romeo	145/146/155/GTV/Spider	2/92-
	Fiat	Brava/Bravo/Coupe/Marea	3/94-
	Lancia	Dedra	4/89-7/99
5011002	Alfa Romeo	145/146/155/GTV/Spider	2/92-
	Fiat	Brava/Bravo/Coupe/Marea	3/94-
	Lancia	Dedra	4/89-7/99
5011003	Alfa Romeo	147/156	11/97-
5011004	Alfa Romeo	147/156	11/97-
5011005	Alfa Romeo	147/156	11/97-
5011006	Alfa Romeo	147/156	11/97-
5011007	Alfa Romeo	Alfa 166	9/98-
5011008	Alfa Romeo	Alfa 166	9/98-
5011009	Alfa Romeo	Alfa 166	9/98-
5011010	Alfa Romeo	Alfa 166	9/98-
5011502	BMW	315 - 323 i (E21)	8/75-3/84
5011503	BMW	315 - 323 i (E21)	8/75-3/84
5011504	BMW	315 - 323 i (E21)	8/75-3/84
5011505	BMW	315 - 323 i (E21)	8/75-3/84
5011506	BMW	518 - 528i E12	8/72-5/81
5011508	BMW	5-Series (E28)&(E34)/	6/81-1/97

Anvendelsesliste
Buyer's guide
Nummerische Liste

NK Nr./No.			
		6-Series(E24)/7-Series(E32)	
5011509	BMW	5-Series (E28)&(E34)/	6/81-1/97
		6-Series(E24)/7-Series(E32)	
5011510	BMW	3-Series (E36)/Z3	9/90-
5011511	BMW	3-Series (E36)/Z3	9/90-
5011512	BMW	5-Series (E34)	1/88-1/97
5011513	BMW	5-Series (E34)	1/88-1/97
5011514	BMW	5-Series (E34)	1/88-1/97
5011515	BMW	5-Series (E34)	1/88-1/97
5011516	BMW	5-Series (E39)	11/95-
5011517	BMW	5-Series (E39)	11/95-
5011518	BMW	5-Series (E39)	11/95-
5011519	BMW	5-Series (E39)	11/95-
5011520	BMW	5-Series (E28)/6-Series(E24)	6/81-9/90
5011521	BMW	5-Series (E28)/6-Series(E24)	6/81-9/90
5011522	BMW	3-Series (E30)	9/82-6/94
5011523	BMW	3-Series (E30)	9/82-6/94
5011525	BMW	5-Series (E39)	4/96-
5011526	BMW	5-Series (E39)	4/96-
5011527	BMW	3-Series (E46)	3/98-
5011528	BMW	3-Series (E46)	3/98-
5011529	BMW	5-Series (E39)	11/95-
5011530	BMW	5-Series (E39)	11/95-
5011531	BMW	5-Series (E39)	4/96-
5011532	BMW	5-Series (E39)	4/96-
5011533	BMW	730i, 740i, 750i E38	10/94-11/01
5011534	BMW	730i, 740i, 750i E38	10/94-11/01
5011535	BMW	730i, 740i, 750i E38	10/94-11/01
5011536	BMW	730i, 740i, 750i E38	10/94-11/01
5011537	BMW	730i, 740i, 750i E38	10/94-11/01
5011538	BMW	730i, 740i, 750i E38	10/94-11/01
5011543	BMW	X5 (E53)	2/02-
5011544	BMW	X5 (E53)	2/02-
5011545	BMW	X5 (E53)	5/00-
5011546	BMW	X5 (E53)	5/00-
5011547	BMW	X5 (E53)	5/00-
5011548	BMW	X5 (E53)	5/00-
5011901	Citroen	AX	6/86-12/98
5011902	Citroen	AX	6/86-12/98
5011905	Citroen	Evasion/Jumpy	6/94-
	Fiat	Scudo/Ulysse (220)	6/94-
	Lancia	Zeta	5/95-9/02
	Peugeot	806/Expert	6/94-
5011906	Citroen	Evasion/Jumpy	6/94-
	Fiat	Scudo/Ulysse (220)	6/94-
	Lancia	Zeta	5/95-9/02
	Peugeot	806/Expert	6/94-
5011909	Citroen	Jumper 230	2/94-4/02
	Fiat	Ducato	3/94-4/02
	Peugeot	Boxer (230)	3/94-4/02
5011910	Citroen	Jumper 230	2/94-4/02

NK Nr./No.			
	Fiat	Ducato	3/94-4/02
	Peugeot	Boxer (230)	3/94-4/02
5011911	Citroen	Jumper 230	2/94-4/02
	Fiat	Ducato	3/94-4/02
	Peugeot	Boxer (230)	3/94-4/02
5011912	Citroen	Jumper 230	2/94-4/02
	Fiat	Ducato	3/94-4/02
	Peugeot	Boxer (230)	3/94-4/02
5011913	Citroen	Berlingo/ZX	3/91-
	Peugeot	Partner	6/96-
5011914	Citroen	Berlingo/ZX	3/91-
	Peugeot	Partner	6/96-
5011915	Citroen	Berlingo/Xsara/ZX	3/91-
	Peugeot	Partner	6/96-
5011916	Citroen	Berlingo/Xsara/ZX	3/91-
	Peugeot	Partner	6/96-
5011917	Citroen	BX/Xsara	9/82-
5011918	Citroen	BX/Xsara	9/82-
5011921	Citroen	Xantia (X1/X2)	3/93-
5011922	Citroen	Xantia (X1/X2)	3/93-
5011923	Citroen	Xantia (X1/X2)	3/93-
5011924	Citroen	Xantia (X1/X2)	3/93-
5011925	Citroen	C 25	9/81-3/94
	Fiat	Ducato/Talento	5/81-3-94
	Peugeot	J5	10/85-2/94
5011926	Citroen	C 25	9/81-3/94
	Fiat	Ducato/Talento	5/81-3-94
	Peugeot	J5	10/85-2/94
5011927	Citroen	C 25	9/81-3/94
	Fiat	Ducato/Talento	5/81-3-94
	Peugeot	J5	10/85-2/94
5011928	Citroen	C 25	9/81-3/94
	Fiat	Ducato/Talento	5/81-3-94
	Peugeot	J5	10/85-2/94
5011933	Citroen	Berlingo/Xsara Picasso	10/96-
	Peugeot	Partner	6/96-
5011934	Citroen	Berlingo/Xsara Picasso	10/96-
	Peugeot	Partner	6/96-
5011935	Citroen	Jumper 230/240	2/94-
	Fiat	Ducato	3/94-
	Peugeot	Boxer (230)/(244)	3/94-
5011936	Citroen	Jumper 230/240	2/94-
	Fiat	Ducato	3/94-
	Peugeot	Boxer (230)/(244)	3/94-
5011937	Citroen	Jumper 230/240	2/94-
	Fiat	Ducato	3/94-
	Peugeot	Boxer (230)/(244)	3/94-
5011938	Citroen	Jumper 230/240	2/94
	Fiat	Ducato	3/94-
	Peugeot	Boxer (230)/(244)	3/94-

Anvendelsesliste
Buyer's guide
Nummerische Liste

NK Nr./No.			
5012203	Nissan	Micra K11	8/92-2/03
5012204	Nissan	Micra K11	8/92-2/03
5012205	Nissan	Primera P10	6/90-8/96
5012206	Nissan	Primera P10	6/90-8/96
5012207	Nissan	Sunny II B12	6/86-6/91
5012208	Nissan	Sunny II B12	6/86-6/91
5012209	Nissan	Sunny III N14&Y10	10/90-
5012210	Nissan	Sunny III N14&Y10	10/90-5/95
5012211	Nissan	Primera P10&P11	6/90-
5012212	Nissan	Primera P10&P11	6/90-
5012213	Nissan	Almera I N15/Primera P11/ Primera Wagon W11	9/95-
5012214	Nissan	Almera I N15/Primera P11/ Primera Wagon W11	9/95-
5012215	Nissan	Sunny II N13	6/86-8/91
5012216	Nissan	Sunny II N13	6/86-8/91
5012221	Nissan	Primera P12 & WP12	3/02-
5012222	Nissan	Primera P12 & WP12	3/02-
5012301	Fiat	127/147/Fiorino	1971-
	Lancia	A 112	1970-12/86
	Seat	Fura - Crono	1/82-12/86
5012303	Fiat	128/Regata/Ritmo	1969-7/89
	Yugo	45/101	1972-95
5012308	Fiat	Duna/Fiorino	11/85-12/98
5012309	Seat	Ibiza/Malaga	5/85-12/93
5012311	Fiat	Uno	1/83-
5012312	Fiat	Uno	1/83-
5012313	Alfa Romeo	Alfa 164	6/87-9/98
	Fiat	Croma	4/86-12/96
	Lancia	Thema (834)	3/86-7/94
5012314	Alfa Romeo	Alfa 164	6/87-9/98
	Fiat	Croma	4/86-12/96
	Lancia	Thema (834)	3/86-7/94
5012315	Fiat	Cinquecento/Seicento	7/91-
5012316	Fiat	Cinquecento/Seicento	7/91-
5012317	Fiat	Tempra/Tipo	11/87-8/96
	Lancia	Dedra	4/89-7/99
5012318	Fiat	Tempra/Tipo	11/87-8/96
	Lancia	Dedra	4/89-7/99
5012319	Fiat	Brava/Bravo/Tempra/Tipo	11/87-10/01
	Lancia	Dedra/Delta	4/89-8/99
5012320	Fiat	Brava/Bravo/Tempra/Tipo	11/87-10/01
	Lancia	Dedra/Delta	4/89-8/99
5012321	Fiat	Barchetta/Punto (176)	9/93-
	Lancia	Y	5/95-
5012322	Fiat	Barchetta/Punto (176)	9/93-
	Lancia	Y	5/95-
5012323	Seat	Ibiza/Malaga	5/8512/93
5012324	Seat	Cordoba/Ibiza/Toledo	3/91-10/02
5012329	Lada	1200/1300/1500/1600	1972-1/87
5012330	Lada	1200/1300/1500/1600	1972-1/87
5012331	Lada	1200/1300/1500/1600	1972-1/87
5012332	Lada	1200/1300/1500/1600	1972-1/87
5012335	Fiat	Palio/Siena	4/96-

NK Nr./No.			
5012336	Fiat	Palio/Siena	4/96-
5012337	Fiat	Palio/Siena	4/96-
5012338	Fiat	Palio/Siena	4/96-
5012343	Seat	Arosa	5/97-
	Volkswagen	Polo/Polo Van	10/94-
5012345	Fiat	Multipla	4/99-
5012346	Fiat	Multipla	4/99-
5012347	Fiat	Punto (176)	9/93-2/00
5012348	Fiat	Punto (176)	9/93-2/00
5012349	Fiat	Punto (176)	9/93-2/00
5012350	Fiat	Punto (176)	9/93-2/00
5012351	Fiat	Doblo/Strada	6/99-
5012352	Fiat	Doblo/Strada	6/99-
5012353	Fiat	Punto (188)	9/99-
5012354	Fiat	Punto (188)	9/99-
5012355	Fiat	Stilo	10/01-
5012356	Fiat	Stilo	10/01-
5012357	Fiat	Daily II	01/01-
5012358	Fiat	Daily II	01/01-
5012359	Fiat	Daily II	01/01-
5012360	Fiat	Daily II	01/01-
5012361	Fiat	Doblo/Strada	3/01-
5012362	Fiat	Doblo/Strada	3/01-
5012365	Fiat	Grande Punto	10/05-
	Fiat	Fiorino	2/08-
	Citroen	Nemo	2/08-
	Peugeot	Bipper	2/08-
5012366	Fiat	Grande Punto	10/05-
	Fiat	Fiorino	2/08-
	Citroen	Nemo	2/08-
	Peugeot	Bipper	2/08-
5012501	Ford	Capri MK I / MK II / MK III & Escort MK. I / MK: II	9/68-4/87
5012503	Ford	Escort MK. III/Orion I	9/80-12/85
5012504	Ford	Escort MK. III/Orion I	9/80-12/85
5012505	Ford	P 100/Sierra	8/82-
5012506	Ford	P 100/Sierra	8/82-
5012507	Ford	Scorpio I&II	4/85-8/98
5012508	Ford	Scorpio I&II	4/85-8/98
5012509	Ford	Escort IV/Orion II	1/86-9/90
5012510	Ford	Escort IV/Orion II	1/86-9/90
5012511	Ford	Fiesta II	8/83-4/89
5012512	Ford	Fiesta II	8/83-4/89
5012513	Ford	Fiesta	5/89-12/91
5012514	Ford	Fiesta	5/89-12/91
5012515	Ford	Fiesta	1/92-12/93
5012516	Ford	Fiesta	1/92-12/93
5012517	Ford	Fiesta	1/92-12/93
5012518	Ford	Fiesta	1/92-12/93
5012519	Ford	Fiesta	1/94-12/95
5012520	Ford	Fiesta	1/94-12/95
5012521	Ford	Fiesta/Ka	1/94-



Anvendelsesliste
Buyer's guide
Nummerische Liste

NK Nr./No.			
5012522	Ford	Fiesta/Ka	1/94-
5012523	Ford	Escort V-VII/Orion III	10/90-7/00
5012524	Ford	Escort V-VII/Orion III	10/90-7/00
5012525	Ford	Mondeo I&II	2/93-
5012526	Ford	Mondeo I&II	2/93-
5012527	Ford	Fiesta	1/96-5/98
	Mazda	121 JA/JB	3/96-
5012528	Ford	Fiesta	1/96-5/98
	Mazda	121 JA/JB	3/96-
5012529	Ford	Fiesta Courier/Puma	2/96-
5012530	Ford	Fiesta Courier/Puma	2/96-
5012531	Ford	Focus	10/98-
5012532	Ford	Focus	10/98-
5012533	Ford	Galaxy	11/95-
	Seat	Alhambra	4/96-
5012533	Volkswagen	Sharan (7M)	5/95-
5012534	Ford	Galaxy	11/95-
	Seat	Alhambra	4/96-
	Volkswagen	Sharan (7M)	5/95-
5012539	Ford	Fiesta	5/98-
5012540	Ford	Fiesta	5/98-
5012541	Ford	Fiesta	11/01-
5012542	Ford	Fiesta	11/01-
5012543	Ford	Ka	9/96-
5012544	Ford	Ka	9/96-
5012545	Ford	Ka	9/96-
5012546	Ford	Ka	9/96-
5012547	Ford	Mondeo III	11/00-
5012548	Ford	Mondeo III	11/00-
5012551	Ford	Focus	2/99-
5012552	Ford	Focus I & II	1/05-
	Mazda	3 & 5	2/04-
	Volvo	S40 II/V50	1/04-
5012607	Honda	Accord I&II	9/81-4/85
5012611	Honda	Civic	10/87-2/92
5012612	Honda	Civic	10/87-2/92
5012613	Honda	Accord III CA4/CA5	5/85-12/89
5012614	Honda	Accord III CA4/CA5	5/85-12/89
5012615	Honda	Accord III CA4/CA5	5/85-12/89
5012616	Honda	Accord III CA4/CA5	5/85-12/89
5012617	Honda	Accord IV&V&VI	1/90-10/98
5012618	Honda	Accord IV&V&VI	1/90-10/98
5012619	Honda	Accord III CA4/CA5	5/85-12/89
5012620	Honda	Accord IV&V&VI	1/90-10/98
5012621	Honda	Accord V & VI CC7/CD7/ CD9/CE1/CE2/CD7/CD8/CD9/CF1	3/93-10/98
5012622	Honda	Accord V & VI CC7/CD7/ CD9/CE1/CE2/CD7/CD8/CD9/CF1	3/93-10/98
5012623	Honda	Civic	10/87-2/92
5012624	Honda	Civic	10/87-2/92
5012625	Honda	Civic	10/91-2/01
5012626	Honda	Civic	10/91-2/01



NK Nr./No.			
5012627	Honda	Accord VII CG/CH	10/98-
5012628	Honda	Accord VII CG/CH	10/98-
5012629	Honda	Accord VII CG/CH	10/98-
5012630	Honda	Accord VII CG/CH	10/98-
5012631	Honda	Civic	10/91-2/01
5012632	Honda	Civic	10/91-2/01
5012633	Honda	Civic EJ6/EJ8/EJ9/EK3/EK4	11/95-2/01
5012634	Honda	Civic EJ6/EJ8/EJ9/EK3/EK4	11/95-2/01
5012635	Honda	Civic EJ6/EJ8/EJ9/EK3/EK4	11/95-2/01
5012636	Honda	Civic EJ6/EJ8/EJ9/EK3/EK4	11/95-2/01
5012637	Honda	Civic MA/MB/MC	9/94-2/01
5012638	Honda	Civic MA/MB/MC	9/94-2/01
5012639	Honda	Civic	10/91-12/98
5012640	Honda	Civic	10/91-12/98
5012641	Honda	Accord IV&V&VI	1/90-10/98
5013001	Mitsubishi	Colt II/Lancer III	10/83-6/92
5013002	Mitsubishi	Colt II/Lancer III	10/83-6/92
5013003	Mitsubishi	Colt III/Lancer IV	4/88-5/94
5013004	Mitsubishi	Colt III/Lancer IV	4/88-5/94
5013005	Mitsubishi	Colt IV/Lancer IV/Lancer V	4/88-
5013006	Mitsubishi	Colt IV/Lancer IV/Lancer V	4/88-
5013007	Mitsubishi	Colt IV/Lancer V	4/92-
5013008	Mitsubishi	Colt IV/Lancer V	4/92-
5013009	Mitsubishi	Colt IV/Lancer V	4/92-
5013010	Mitsubishi	Colt IV/Lancer V	4/92-
5013205	Mazda	626 II GC	11/82-1987
5013206	Mazda	626 II GC	11/82-1987
5013207	Mazda	626 III GD	5/87-5/92
5013208	Mazda	626 III GD	5/87-5/92
5013209	Mazda	323 III	5/85-3/93
5013210	Mazda	323 III	5/85-3/93
5013211	Mazda	323 IV BG	9/89-10/94
5013212	Mazda	323 IV BG	9/89-10/94
5013213	Mazda	323 III BF	5/85-10/89
5013214	Mazda	323 III BF	5/85-10/89
5013216	Mazda	626 IV GE	8/91-4/97
5013217	Mazda	626 IV GE	8/91-4/97
5013219	Mazda	323 IV BG	9/89-10/94
5013220	Mazda	323 IV BG	9/89-10/94
5013221	Mazda	323 V BA	8/94-9/98
5013222	Mazda	323 V BA	8/94-9/98
5013301	MB	200/220/230/240/250/ 280/300 (T123/W123/C123)	1976-10/84
5013302	MB	200/220/230/240/250/ 280/300 (T123/W123/C123)	1976-10/84
5013304	MB	W124/W201	11/84-3/98
5013305	MB	W124/W201	11/84-3/98
5013306	MB	W201 190 D/E	10/82-8/93
5013307	MB	W201 190 D/E	10/82-8/93
5013308	MB	W201 190 D/E	10/82-8/93
5013309	MB	W201 190 D/E	10/82-8/93

Anvendelsesliste
Buyer's guide
Nummerische Liste

NK Nr./No.			
5013312	MB	W202/W208	3/93-
5013313	MB	W202/W208	3/93-
5013314	MB	W202/W208/W210	3/93-
5013315	MB	W202/W208/W210	3/93-
5013321	MB	W 168 A-Klasse	7/97-
5013322	MB	W 168 A-Klasse	7/97-
5013323	MB	W140	2/91-2/99
5013324	MB	W140	2/91-2/99
5013325	MB	W140	2/91-2/99
5013326	MB	W140	2/91-2/99
5013345	MB	SPRINTER (901, 902, 903, 904)	2/95-
	Volkswagen	LT 28-35 II/LT 28-46 II	5/96-
5013346	MB	SPRINTER (901, 902, 903, 904)	2/95-
	Volkswagen	LT 28-35 II/LT 28-46 II	5/96-
5013401	Hyundai	Accent X3	10/94-01/00
5013402	Hyundai	Accent X3	10/94-01/00
5013403	Hyundai	Atos MX	2/98-
5013404	Hyundai	Atos MX	2/98-
5013405	Hyundai	Coupe RD/Elantra (Lantra) J2	11/95-
5013406	Hyundai	Coupe RD/Elantra (Lantra) J2	11/95-
5013407	Hyundai	Excel/Pony X2/S-Coupe	1/90-5/96
5013408	Hyundai	Excel/Pony X2/S-Coupe	1/90-5/96
5013503	Kla	Carnival I & II	7/02-
5013504	Kla	Carnival I & II	7/02-
5013601	Opel	Kadett C & Kadett City	8/73-8/79
5013602	Opel	Kadett C & Kadett City	8/73-8/79
5013603	Opel	Kadett C & Kadett City	8/73-8/79
5013604	Opel	Kadett C & Kadett City	8/73-8/79
5013605	Daewoo	Espero/Lanos/Nexia	2/95-
	Opel	Kadett D&E	10/81-2/93
5013606	Daewoo	Espero/Lanos/Nexia	2/95-
	Opel	Kadett D&E	10/81-2/93
5013607	Opel	Astra F/Calibra/Vectra A	9/88-
	Vauxhall	Astra MK III/Astravan MK III/ Cavalier MK III	9/88-3/01
5013608	Opel	Astra F/Calibra/Vectra A	9/88-
	Vauxhall	Astra MK III/Astravan MK III/ Cavalier MK III	9/88-3/01
5013609	Opel	Corsa A	9/82-3/93
5013610	Opel	Corsa A	9/82-3/93
5013613	Opel	Combo (Corsa)/Corsa B/Tigra	3/93-10/01
	Vauxhall	Combo (Corsa)/Corsa B/Tigra	3/93-10/01
5013614	Opel	Combo (Corsa)/Corsa B/Tigra	3/93-10/01
	Vauxhall	Combo (Corsa)/Corsa B/Tigra	3/93-10/01
5013615	Opel	Astra G/Vectra B/Zafira	10/95-
	Vauxhall	Astra MK IV/Astravan MK IV/ Vectra/Zafira	10/95-
5013616	Opel	Astra G/Vectra B/Zafira	10/95-
	Vauxhall	Astra MK IV/Astravan MK IV/	10/95-

NK Nr./No.			
		Vectra/Zafira	
5013619	Opel	Agila H00	9/00-
	Vauxhall	Agila H00	9/00-
5013621	Opel	Combo (Corsa)/Corsa B/Tigra	3/93-10/01
	Vauxhall	Combo (Corsa)/Corsa B/Tigra	3/93-10/01
5013622	Opel	Combo (Corsa)/Corsa B/Tigra	3/93-10/01
	Vauxhall	Combo (Corsa)/Corsa B/Tigra	3/93-10/01
5013623	Opel	Corsa C	9/00-
	Vauxhall	Corsa MK II	9/00-
5013624	Opel	Corsa C	9/00-
	Vauxhall	Corsa MK II	9/00-
5013625	Opel	Omega B	3/94-7/03
	Vauxhall	Omega B	3/94-
5013626	Opel	Omega B	3/94-7/03
	Vauxhall	Omega B	3/94-
5013629	Opel	Signum/Vectra C	5/03-
	Vauxhall	Vectra Mk II	5/03-
5013701	Citroen	C15/Visa	1980-12/97
	Peugeot	205	2/83-9/98
5013702	Citroen	C15/Visa	1980-12/97
	Peugeot	205	2/83-9/98
5013703	Peugeot	309	10/85-12/93
5013704	Peugeot	309	10/85-12/93
5013705	Citroen	AX/Saxo	6/86-
	Peugeot	106 I & II (- XSi)	9/91-
5013706	Citroen	AX/Saxo	6/86-
	Peugeot	106 I & II (- XSi)	9/91-
5013707	Citroen	Saxo	3/96-
	Peugeot	106 I & II Xsi	9/91-
5013708	Citroen	Saxo	3/96-
	Peugeot	106 I & II Xsi	9/91-
5013709	Peugeot	306	3/93-
5013710	Peugeot	306	3/93-
5013711	Peugeot	306	3/93-
5013712	Peugeot	306	3/93-
5013715	Peugeot	405	5/87-10/96
5013716	Peugeot	405	5/87-10/96
5013717	Peugeot	406	10/95-
5013718	Peugeot	406	10/95-
5013719	Peugeot	605/607	10/89-
5013720	Peugeot	605/607	10/89-
5013721	Peugeot	605	10/89-
5013722	Peugeot	605	10/89-
5013723	Peugeot	206	9/98-
5013724	Peugeot	206	9/98-
5013725	Peugeot	307	10/01-
5013726	Peugeot	307	10/01-
5013727	Peugeot	405	5/87-10/96
5013728	Peugeot	405	5/87-10/96
5013729	Peugeot	309	10/85-12/93
5013730	Peugeot	309	10/85-12/93



Anvendelsesliste
Buyer's guide
Nummerische Liste

NK Nr./No.			
5013731	Citroen	Visa	1980-3/91
	Peugeot	205	2/83-9/98
5013732	Citroen	Visa	1980-3/91
	Peugeot	205	2/83-9/98
5013903	Renault	R5 (Super 5)/Rapid	10/84-3/98
5013904	Renault	R5 (Super 5)/Rapid	10/84-3/98
5013905	Renault	Clio I	1/91-9/98
5013906	Renault	Clio I	1/91-9/98
5013907	Renault	Twingo	3/93-
5013908	Renault	Twingo	3/93-
5013909	Renault	Megane I/Megane Scenic/R19	11/88-
5013910	Renault	Megane I/Megane Scenic/R19	11/88-
5013911	Renault	Clio II/Kangoo	2/98-
5013912	Renault	Clio II/Kangoo	2/98-
5013913	Renault	Laguna	11/93-3/01
5013914	Renault	Laguna	11/93-3/01
5013917	Renault	Megane I/Megane Scenic	1/96-
5013918	Renault	Megane I/Megane Scenic	1/96-
5013919	Renault	Megane I/Megane Scenic	1/96-
5013920	Renault	Megane I/Megane Scenic	1/96-
5013921	Opel	Movano	7/98-
	Renault	Master II	7/98-
	Vauxhall	Movano	7/98-
5013922	Opel	Movano	7/98-
	Renault	Master II	7/98-
	Vauxhall	Movano	7/98-
5013923	Renault	Espace III JE_	11/96-
5013924	Renault	Espace III JE_	11/96-
5014001	Honda	Concerto HW	8/89-3/95
	Rover Group	Rover 214/216/218/220/ 414/416/418/420	10/89-
5014002	Honda	Concerto HW	8/89-3/95
	Rover Group	Rover 214/216/218/220/ 414/416/418/420	10/89-
5014301	Skoda	Favorit/Felicia/Forman	5/89-
5014302	Skoda	Fabia	12/99-
	Volkswagen	Polo (9N_)	10/01-
5014305	Skoda	Felicia	1/98-
5014306	Skoda	Felicia	1/98-
5014502	Toyota	Starlet KP60 Serie	2/78-9/84
5014505	Toyota	CorollaAE92/AE95/EE90/CE905/87-6/93	
5014506	Toyota	CorollaAE92/AE95/EE90/CE905/87-6/93	
5014507	Toyota	CorollaAE10#/EE10#/CE10#5/92-4/97	
5014508	Toyota	CorollaAE10#/EE10#/CE10#5/92-4/97	
5014509	Toyota	Carina EAT19#/ST19#/CT19# 2/92-9/97	
5014510	Toyota	Carina EAT19#/ST19#/CT19# 2/92-9/97	
5014511	Toyota	Yaris_CP10 / Yaris Verso NC/LP	4/99-
5014512	Toyota	Yaris_CP10 / Yaris Verso NC/LP	4/99-
5014515	Toyota	Corolla (_E12_)/	1/02-



NK Nr./No.			
	Toyota	Corolla Verso (_E12J)	
5014516	Toyota	Corolla (_E12_)/	1/02-
	Toyota	Corolla Verso (_E12J)	
5014701	Volkswagen	Derby/Polo	4/75-8/94
5014702	Audi	50	1975-78
	Volkswagen	Derby/Polo	4/75-8/94
5014703	Volkswagen	Caddy I/Golf Cabrio I (155)/ Golf I (17)/Jetta I (17)/Scirocco	2/74-7/92
5014706	Audi	100	8/76-7/91
5014707	Audi	100	8/76-7/91
5014708	Audi	100/200	8/76-12/91
5014709	Audi	100/200	8/76-12/91
5014710	Seat	Inca	11/95-
	Volkswagen	Caddy II/Corrado/Golf II/Jetta II/Polo8/83-	
5014711	Audi	100/200/V8	8/82-2/94
5014712	Audi	100/200/V8	8/82-2/94
5014713	Audi	100/A6	12/90-12/97
5014714	Audi	100/A6	12/90-12/97
5014716	Audi	A4/A6/A8	3/94-
	Volkswagen	Passat	8/96-
5014717	Audi	A3 (8L1)	6/96-
	Seat	Ibiza/Leon/Toledo II	4/99-
	Skoda	Octavia (1U2 & 1U5)	9/96-
	Volkswagen	Bora/Golf IV/New Beetle	1/98-
5014718	Audi	A3 (8L1)	6/96-
	Seat	Ibiza/Leon/Toledo II	4/99-
	Skoda	Octavia (1U2 & 1U5)	9/96-
	Volkswagen	Bora/Golf IV/New Beetle	1/98-
5014719	Audi	A4/A6/A8	3/94-
	Volkswagen	Passat	8/96-
	Skoda	Superb	2/02-
5014720	Audi	A4/A6/A8	3/94-
	Volkswagen	Passat	8/96-
	Skoda	Superp	2/02-
5014725	Volkswagen	Golf III/Vento	11/91-4/99
5014726	Volkswagen	Passat (35l)	2/88-5/97
5014727	Audi	A4/A6	1/95-
	Volkswagen	Passat	8/96-
	Skoda	Superb	2/02-
5014728	Audi	A4/A6	1/95-
	Volkswagen	Passat	8/96-
	Skoda	Superb	2/02-
5014729	Audi	A8 (4D2, 4D8)	3/94-
5014730	Audi	80 (B4)/Cabriolet	5/91-
5014731	Audi	80 (B4)/Cabriolet	5/91-
5014733	Audi	A4/A6/A8	3/94-
	Volkswagen	Passat	8/96-
	Skoda	Superb	2/02-
5014734	Audi	A4/A6/A8	3/94-
	Volkswagen	Passat	8/96-
	Skoda	Superb	2/02-

Anvendelsesliste
Buyer's guide
Nummerische Liste

NK Nr./No.			
5014737	Seat	Arosa	5/97-
	Volkswagen	Lupo	4/97-
5014738	Volkswagen	Passat (3B2)(3B5)	3/97-11/00
	Volkswagen	Passat (3B3)(3B6)	11/00-
	Skoda	Superb	2/02-
	Audi	A4 (8D2-B5)(8D5-B5)	1/95-9/01
5014747	Volkswagen	Passat (3B3)(3B5)	11/00-
	Skoda	Superb	2/02-
5014804	Volvo	240 & 260 Series	8/74-7/93
5014805	Volvo	240 & 260 Series	8/74-7/93
5014806	Volvo	240 & 260 Series	1974-8/93
5014807	Volvo	S40/V40	7/95-
5014808	Volvo	S40/V40	7/95-
5014809	Volvo	850/C70/S70/V70	6/91-
5014810	Volvo	850/C70/S70/V70	6/91-
5015001	Daewoo	Matiz/Tico	2/95-
5015003	Daewoo	Nubria	5/97-
5015004	Daewoo	Nubria	5/97-
5015005	Daewoo	Nubria	5/97-
5015006	Daewoo	Nubria	5/97-
5015201	Suzuki	Wagon R+ (EM)	2/98-
5021906	Citroen	AX	6/86-12/98
5021907	Citroen	C 25	9/81-3/94
5021908	Citroen	ZX	3/91-1997
5022301	Fiat	127/128/Fiorino	1969-
	Lancia	A 112	1970-12/86
5022307	Fiat	Uno	1/83-
5022312	Fiat	Ducato	5/81-3-94
5022314	Fiat	Panda 750/1000	3/80-
5022505	Ford	Escort III&IV/ Orion I&II	9/80-9/90
5022506	Ford	Cortina MK III/Taurus	1970-82
5022507	Ford	Sierra	8/82-2/93
5022513	Ford	Fiesta	5/89-12/95
5022514	Ford	Escort V-VII/Orion III	10/90-7/00
5023603	Opel	Kadett C & Kadett City	8/73-8/79
	Vauxhall	Chevette	1975-82
5023607	Opel	Ascona B/Manta B	9/75-8/81
	Vauxhall	Cavalier	1975-8/81
5023706	Citroen	C15/Visa	1980-12/97
	Peugeot	205	2/83-9/98
5023707	Peugeot	309	10/85-12/93
5023708	Peugeot	405	5/87-10/96
5023903	Renault	R4/R6	5/78-12/93
5023904	Renault	R5	5/78-84
5023912	Renault	R5 (Super 5)	10/84-12/96
5024701	Audi	50	1975-78
	Volkswagen	Derby/Polo	4/75-8/94
5024706	Volkswagen	Golf II/Jetta II	8/83-12/92
5024710	Volkswagen	Transporter Type III	5/79-7/92
5024801	Volvo	240 & 260 Series	8/74-7/93



NK Nr./No.			
5031001	Alfa Romeo	Alfa 33/Alfasud/Arna	1971-9/94
5031002	Alfa Romeo	Alfa 75&90/Alfetta/Giulietta	1972-2/92
5031003	Alfa Romeo	Alfa 75&90/Alfetta/Giulietta	1972-2/92
5031006	Alfa Romeo	Alfa 155	2/92-12/97
	Fiat	Coupe	3/94-
5031007	Alfa Romeo	Alfa 145 & 146 1.4/1.6/1.7	10/94-1/01
5031008	Alfa Romeo	Alfa 145 & 146 1.4/1.6/1.7	10/94-1/01
5031011	Alfa Romeo	147/156/166	11/97-
5031012	Alfa Romeo	147/156/166	11/97-
5031201	Rover Group	Allegro/Maxi/Metro/Mini	1959-
	Vauxhall	Viva HA/HB/HC / Firenza	1971-
5031204	Rover Group	Maestro/Montego	1983-
5031408	Isuzu	KB/Trooper	1979-
5031410	Isuzu	Campo/Pick-up/Trooper	11/86-
	Opel	Campo/Frontera A/ Monterey A & B	8/91-
	Vauxhall	Frontera/Monterey	9/91-8/99
5031411	Isuzu	Campo/Pick-up/Trooper	11/86-
	Opel	Campo/Frontera A/ Monterey A & B	8/91-
	Vauxhall	Frontera/Monterey	9/91-8/99
5031504	BMW	315 - 323 i (E21)	8/75-3/84
5031505	BMW	3-Series (E30)/Z1	9/82-6/94
5031508	BMW	5-Series (E28)&(E34)/ 6-Series (E24)/7-Series (E32)/ 8-Series (E31)	6/81-12/99
5031509	BMW	5-Series (E28)&(E34)/ 6-Series (E24)/7-Series (E32)/ 8-Series (E31)	6/81-12/99
5031511	BMW	3-Series (E36)/ 5-Series (E34)/Z3	1/88-
5031512	BMW	3-Series (E36)/ 5-Series (E34)/Z3	1/88-
5031513	BMW	5-Series (E39)	11/95-
5031514	BMW	5-Series (E39)	11/95-
5031515	BMW	5-Series (E39)	11/95-
5031516	BMW	3-Series (E36)/Z3	9/90-
5031517	BMW	3-Series (E46)	3/98-
5031518	BMW	3-Series (E46)	3/98-
5031519	BMW	3-Series (E46)	3/98-
5031521	BMW	5-Series (E39)	4/96-
5031522	BMW	5-Series (E39)	4/96-
5031523	BMW	730i, 740i, 750i E38	10/94-11/01
5031524	BMW	730i, 740i, 750i E38	10/94-11/01
5031803	Talbot	1100/1307/1308/1309/ 1510/Horizon/Solara	1972-7/86
5031807	Talbot	Horizon	11/77-6/86
5031905	Citroen	BX & BX Break	9/82-12/94
5031906	Citroen	BX & BX Break	9/82-12/94



Anvendelsesliste
Buyer's guide
Nummerische Liste

NK Nr./No.			
5031907	Citroen	BX & BX Break	9/82-12/94
5031914	Citroen	Berlingo/Xsara/ZX	3/91-
	Peugeot	Partner	6/96-
5031915	Citroen	Xantia (X1/X2)	3/93-
5031916	Citroen	Evasion/Jumpy	6/94-
	Fiat	Scudo/Ulysse (220)	6/94-
	Lancia	Zeta	5/95-9/02
	Peugeot	806/Expert	6/94-
5031917	Citroen	Evasion/Jumpy	6/94-
	Fiat	Marea/Multipla/Scudo/ Ulysse (220)	6/94-
	Lancia	Zeta	5/95-9/02
	Peugeot	806/Expert	6/94-
5031918	Citroen	Jumper 230	2/94-4/02
	Fiat	Ducato	3/94-4/02
	Peugeot	Boxer (230)	3/94-4/02
5031919	Citroen	Jumper 230	2/94-4/02
	Fiat	Ducato	3/94-4/02
	Peugeot	Boxer (230)	3/94-4/02
5031922	Citroen	Saxo	3/96-
	Peugeot	106 I & II (- XSi)	9/91-
5031923	Citroen	Saxo	3/96-
	Peugeot	106 I & II (- XSi)	9/91-
5031924	Citroen	Saxo	3/96-
	Peugeot	106 I & II Xsi	9/91-
5031925	Citroen	Saxo	3/96-
	Peugeot	106 I & II Xsi	9/91-
5031927	Citroen	C3	2/02-
5031928	Citroen	C3	2/02-
5031929	Citroen	C3	2/02-
5031933	Citroen	C5	3/01-
5031934	Citroen	Berlingo/Xsara Picasso	10/96-
5032204	Nissan	Cherry N12/Stanza T11/ Sunny I B11	8/81-9/87
5032205	Nissan	200/Bluebird/Cherry/Micra/ Prairie/Silvia/Stanza/Sunny I&II	8/81-
5032222	Nissan	Patrol 160	11/79-8/88
5032225	Nissan	Vanette C120	6/81-12/87
5032240	Nissan	100/Bluebird/Primera Wagon/ Sunny III	4/84-
5032242	Nissan	Sunny II	6/86-8/91
5032244	Nissan	Micra K10	12/82-7/92
5032245	Nissan	King Cab	9/79-2/98
5032246	Nissan	King Cab	8/85-2/98
5032247	Ford	Maverick	2/93-4/98
	Nissan	King Cab/Terrano I&II	8/85-
5032248	Ford	Maverick	2/93-4/98
	Nissan	King Cab/Terrano I&II	8/85-
5032249	Nissan	Vanette C22	5/86-12/95
5032250	Nissan	Vanette C22	5/86-12/95

NK Nr./No.			
5032251	Nissan	Vanette C22	5/86-12/95
5032252	Nissan	Vanette C22	5/86-12/95
5032253	Nissan	300 ZX (Z32)/Sunny II N13	6/86-9/95
5032254	Nissan	Micra K10	12/82-7/92
5032256	Nissan	King van E24/Urvan E24	9/86-
5032257	Nissan	King van E24/Urvan E24	9/86-
5032258	Nissan	Primera/Serena/Vanette	6/90-
5032259	Nissan	Maxima J30/Primera P10	10/88-8/96
5032260	Nissan	100 NX B13/Almera I N15/ Primera Wagon W10	3/90-7/00
5032261	Nissan	Micra K11	8/92-2/03
5032262	Nissan	Almera II N16	7/00-
5032263	Nissan	King Cab D21- Pick-Up D21	8/85-2/98
5032264	Nissan	King Cab D21 - Pick-Up D21	8/85-2/98
5032265	Nissan	Vanette HC23	1/95-
5032266	Nissan	King Van E24/Urvan E24	9/86-
5032267	Nissan	King Van E24/Urvan E24	9/86-
5032303	Fiat	Cinquecento/Regata/ Ritmo/Seicento	6/83-
	Lancia	A 112	1970-12/86
	Seat	Ibiza/Malaga	5/85-12/93
5032305	Fiat	126	1972-78
5032307	Fiat	127/147/Fiorino	1971-
5032308	Fiat	127/147/Duna/Fiorino/Uno	1971-
	Lancia	Y 10	3/85-12/95
	Seat	Fura - Crono	1/82-12/86
5032309	Fiat	128	1969-12/84
	Yugo	101	1972-93
5032315	Fiat	132/Argenta	1972-7/86
	Lada	1200/1300/1500/1600/Niva	1972-1985
	Pol ski Fiat	Polonez	1981-
5032318	Fiat	Panda	3/80-
	Seat	Marbella	1980-
5032324	Lada	1200/1300/1500/1600	1972-1/87
5032325	Lada	1200/1300/1500/1600	1972-1/87
5032328	Citroen	C 25	9/81-3/94
	Fiat	Ducato/Talento	5/81-3-94
	Peugeot	J5	9/81-1994
5032330	Alfa Romeo	Alfa 164	6/87-9/98
	Fiat	Croma	4/86-12/96
	Lancia	Kappa/Thema (834)	3/86-
5032331	Fiat	Croma	4/86-12/96
	Lancia	Thema (834)	3/86-7/94
5032333	Alfa Romeo	Alfa 155	2/92-12/97
	Fiat	Brava/Bravo/Coupe/ Tempra/Tipo	11/87-10/01
	Lancia	Dedra/Delta	4/89-8/99
5032334	Alfa Romeo	Alfa 155	2/92-12/97
	Fiat	Brava/Bravo/Coupe/ Tempra/Tipo	11/87-10/01



Anvendelsesliste
Buyer's guide
Nummerische Liste

NK Nr./No.			
	Lancia	Dedra/Delta	4/89-8/99
5032335	Lada	Samara	3/85-
5032336	Lada	Samara	3/85-
5032338	Citroen	C 25	9/81-3/94
	Fiat	Ducato/Talento	5/81-3-94
	Peugeot	J5	9/81-1994
5032342	Fiat	Cinquecento/Seicento	7/91-
5032343	Fiat	Brava/Bravo/Tempra/Tipo	11/87-10/01
	Lancia	Dedra/Delta	4/89-8/99
5032344	Fiat	Barchetta/Punto	9/93-
	Lancia	Y	5/95-
5032345	Fiat	Punto (176)	9/93-2/00
5032346	Fiat	Barchetta/Punto	9/93-
	Lancia	Y	5/95-
5032347	Fiat	Duna/Uno	1/83-
	Seat	Ibiza/Malaga	5/85-12/93
5032348	Seat	Cordoba/Ibiza/Toledo	3/91-10/02
5032349	Fiat	Brava/Bravo	10/95-10/01
5032350	Fiat	Brava/Bravo	10/95-10/01
5032352	Fiat	Palio/Siena/Strada	4/96-
5032353	Fiat	Palio/Siena/Strada	4/96-
5032358	Seat	Arosa	5/97-
	Volkswagen	Lupo/Polo	10/94-
5032359	Fiat	Doblo/Marea/Multipla	9/96-
5032360	Fiat	Marea	9/96-
5032361	Fiat	Doblo	3/01-
5032362	Fiat	Palio/Siena	4/96-
5032363	Fiat	Punto (188)	9/99-
5032364	Fiat	Stilo	10/01-
5032365	Fiat	Stilo	10/01-
5032367	Lada	110/111/112	1/95-
5032368	Lada	110/111/112	1/95-
5032501	Ford	Escort/Fiesta/Orion	9/68-12/93
5032503	Ford	Consul/Cortina/Escort/ Granada/Taurus	1970-8/85
5032504	Ford	Escort V-VII/Scorpio I/Sierra	8/82-7/00
5032505	Ford	Escort V-VII/Scorpio I/Sierra	8/82-7/00
5032506	Ford	Sierra	8/82-2/93
5032507	Ford	P 100/Scorpio I	4/85-
5032508	Ford	Transit	1965-9/85
5032509	Ford	Transit	1965-9/85
5032513	Ford	Transit (T_) 130-190 & 100L	10/85-9/92
5032514	Ford	Transit (T_) 130-190 & 100L	10/85-9/92
5032515	Ford	Transit (T_) 130-190 & 100L	10/85-9/92
5032516	Ford	Transit (T_) 130-190 & 100L	10/85-9/92
5032517	Ford	Fiesta II	8/83-4/89
5032518	Ford	Fiesta	5/89-12/95
5032519	Ford	Transit (T_) 80-120	10/85-9/92



NK Nr./No.			
5032522	Ford	Escort/Orion	9/80-9/90
5032523	Ford	Escort/Orion	10/90-7/00
5032524	Ford	Escort/Orion	10/90-7/00
5032525	Ford	Escort/Orion	10/90-7/00
5032526	Ford	Fiesta/Puma	1/96-
	Mazda	121 JA/JB	3/96-
5032527	Ford	Fiesta/Puma	1/96-
	Mazda	121 JA/JB	3/96-
5032528	Ford	Mondeo I	2/93-8/96
5032529	Ford	Mondeo I	2/93-8/96
5032530	Ford	Mondeo I	2/93-8/96
5032531	Ford	Fiesta	1/94-12/95
5032532	Ford	Transit	10/85-3/00
5032533	Ford	Transit	10/85-3/00
5032534	Ford	Fiesta	1/96-
5032536	Ford	Ka	9/96-
5032537	Ford	Ka	9/96-
5032538	Ford	Focus	10/98-
5032539	Ford	Focus	10/98-
5032541	Ford	Galaxy	11/95-
	Seat	Alhambra	4/96-
	Volkswagen	Sharan (7M)	5/95-
5032542	Ford	Galaxy	11/95-
	Seat	Alhambra	4/96-
	Volkswagen	Sharan (7M)	5/95-
5032543	Ford	Galaxy	11/95-
	Seat	Alhambra	4/96-
	Volkswagen	Sharan (7M)	5/95-
5032544	Ford	Mondeo I&II	2/93-
5032545	Ford	Cougar/Mondeo II	9/96-
5032546	Ford	Cougar/Mondeo II	9/96-
5032547	Ford	Cougar/Mondeo II	9/96-
5032548	Ford	Transit (T_) 130-190 & 100L	10/85-9/92
5032549	Ford	Transit (T_) 130-190 & 100L	10/85-9/92
5032550	Ford	Transit (T_) 130-190 & 100L	10/85-9/92
5032551	Ford	Transit (T_) 130-190 & 100L	10/85-9/92
5032552	Ford	Escort V-VII/Orion III	10/90-7/00
5032553	Ford	Focus/Transit Connect	10/98-
5032554	Ford	Scorpio II	10/94-8/98
5032555	Ford	Fiesta	11/01-
5032556	Ford	Fiesta	11/01-
5032557	Ford	Mondeo III	11/00-
5032558	Ford	Mondeo III	11/00-
5032559	Ford	Scorpio II	10/94-8/98
5032560	Ford	Scorpio II	10/94-8/98
5032561	Ford	Transit (F#_Y, F#_Y)	3/00-
5032563	Ford	Transit (F#_Y, F#_Y)	3/00-
5032564	Ford	Transit (F#_Y, F#_Y)	3/00-
5032565	Ford	Transit Connect	9/02-
5032566	Ford	Fiesta/Fusion	11/01-
	Mazda	2	4/03-

Anvendelsesliste
Buyer's guide
Nummerische Liste

NK Nr./No.			
5032601	Honda	Accord I&II&III/Ballade/ Civic/Prelude/Quintet	1975-12/89
5032603	Honda	Accord I&III/Ballade/ Civic/Prelude/Quintet	11/78-12/89
5032604	Honda	Ballade/Civic	10/83-10/87
5032605	Honda	Accord II AC/AD	6/83-4/85
5032606	Honda	Civic	10/87-2/92
5032607	Honda	Civic	10/87-2/92
5032608	Honda	Civic	10/87-2/92
5032609	Honda	Civic	10/91-2/01
5032610	Honda	Accord IV/V&VI	1/90-10/98
	Rover Group	Rover 620-623	8/93-2/99
5032611	Honda	Accord IV/V&VI	1/90-10/98
	Rover Group	Rover 620-623	8/93-2/99
5032612	Honda	Accord IV/V&VI	1/90-10/98
5032613	Honda	Prelude BA	4/87-1/92
5032614	Honda	Prelude BB	2/92-
5032615	Honda	Civic/CR-V/Integra	10/91-
	Rover Group	Rover 45	2/00-
5032616	Honda	Civic/CR-V/Integra	10/91-
	Rover Group	Rover 45	2/00-
5032617	Honda	Accord VII/Shuttle	10/94-
5032618	Honda	Accord VII/Shuttle	10/94-
5032623	Honda	CR-V I (RD)	1/99-
5033001	Hyundai	Excel/Pony X2/H-1/ Starex/H100/S-Coupe	1/90-
5033001	Mitsubishi	Colt I/Lancer F II	12/78-1/84
5033003	Mitsubishi	Galant/L200/Lancer/ Sapporo/Starion	5/76-8/96
5033007	Mitsubishi	L 200/L300/Pajero	9/80-8/96
5033008	Mitsubishi	L 200/L300/Pajero	9/80-8/96
5033010	Mitsubishi	Colt II/Lancer III	10/83-6/92
5033012	Hyundai	Sonata I Y2	9/88-10/93
	Mitsubishi	Cordia/Eclipse/Galant/L300/ Pajero/Sigma/Space Runner/ Space Wagon/Tredia	10/82-
5033013	Mitsubishi	Cordia/Galant/ Space Wagon/Tredia	10/82-4/91
5033014	Hyundai	Atos MX/Elantra (Lantra) J1	10/90-
	Mitsubishi	Carisma/Colt/Lancer/ Space Star	10/83-
5033015	Mitsubishi	L 200	8/80-8/96
5033016	Mitsubishi	Colt III/Lancer IV	4/88-5/94
5033017	Hyundai	H100	7/93-3/00
	Mitsubishi	Galant IV/L300	6/86-
5033018	Mitsubishi	L 300 LO Serie 2WD	10/82-4/94
5033019	Mitsubishi	Pajero II V-Serie/ Space Gear P-Serie	12/90-
5033021	Mitsubishi	L 300/L400	6/86-
5033022	Mitsubishi	L 300/L400	6/86-
5033023	Mitsubishi	Colt IV&V/Lancer V	4/92-
5033202	Mazda	323 I/626 I/818/929	10/72-5/86



NK Nr./No.			
5033203	Mazda	323 II BD	8/80-12/85
5033204	Mazda	323 II BD	8/80-12/85
5033208	Kia	Clarus/Pride/Sephia/Shuma	9/93-
	Mazda	626/929/MX-6	8/81-
5033211	Mazda	818/929	1972-7/81
5033217	Mazda	626 II GC	11/82-1987
5033218	Mazda	626 II GC	11/82-1987
5033219	Mazda	323 II BD	8/80-12/85
5033220	Mazda	B 1800/B 2000/B 2200	10/81-12/96
5033222	Mazda	121/323 III	5/85-3/96
5033223	Mazda	323 III	5/85-3/93
5033225	Ford	Econovan	3/86-3/92
	Kia	Besta	2/96-
	Mazda	E 2000/E 2200	5/83-
5033226	Mazda	323 IV BG	9/89-10/94
5033227	Mazda	323 IV BG/MX-3	9/89-
5033228	Mazda	323 IV BG/MX-3	9/89-
5033229	Mazda	323 IV&V/Demio/MX-3	9/89-
5033230	Mazda	626 III	5/87-9/97
5033232	Mazda	B 2000/B 2200	1/85-12/96
5033235	Mazda	323/626/MPV/Premacy/ Xedos 6	5/87-
5033236	Kia	Besta	2/96-
5033237	Mazda	626 V GF	5/97-
5033301	MB	W114/W115/C123/T123/ W123/C126/W126	1968/6/91
5033302	MB	W114/W115/C126/W126	1968/6/91
5033303	MB	C123/T123/W 123	1976-10/84
5033304	MB	C123/T123/W 123	1976-10/84
5033305	MB	C123/T123/W123	1976-10/84
5033316	MB	W201 190 D/E	10/82-8/93
5033317	MB	W201 190 D/E	10/82-8/93
5033319	MB	C123/T123/W 123/W124	1976-3/98
5033321	MB	W124	11/84-3/98
5033322	MB	W201 190 D/E	10/82-8/93
5033323	MB	W210	6/95-3/03
5033324	MB	W210	6/95-3/03
5033325	MB	W210	6/95-3/03
5033326	MB	W202/W208	3/93-
5033327	MB	W140	2/91-2/99
5033328	MB	W140	2/91-2/99
5033329	MB	W 168 A-Klasse	7/97-
5033330	MB	W 168 A-Klasse	7/97-
5033331	MB	W 168 A-Klasse	7/97-
5033332	MB	W163 ML	2/98-
5033334	MB	207D/208/209 D/210/210D/ 307D/308/309D/310D/Sprinter	
5033335	MB	207D/208/209 D/210/210D/ 307D/308/309D/310D/Sprinter	
5033336	MB	Sprinter	2/95-

Anvendelsesliste
Buyer's guide
Nummerische Liste

NK Nr./No.			
5033337	Volkswagen	LT 28-35 II, LT 28-46 II	5/96-
	MB	Sprinter	2/95-
	Volkswagen	LT 28-35 II, LT 28-46 II	5/96-
5033338	MB	W203 C	5/00-
5033339	MB	W203 C	5/00-
5033340	MB	W203 C	5/00-
5033341	MB	W163 ML	2/98-
5033342	MB	W163 ML	2/98-
5033343	MB	Vito (638)/V-klasse (638/2)	2/96-
5033344	MB	Vito (638)/V-klasse (638/2)	2/96-
5033355	MB	S-Class (W220)	1/00-
5033401	Hyundai	Accent/Coupe/ Elantra (Lantra) J2	10/94-
	Kia	Carens I	2/96-7/02
5033402	Hyundai	Accent X3/Excel/ Pony X2/S-Coupe	1/90-01/00
5033403	Hyundai	Elantra (Lantra) J1/ Sonata II&III	10/90-10/01
5033404	Hyundai	Elantra (Lantra) J1	10/90-10/95
5033405	Hyundai	Elantra (Lantra) J1	10/90-10/95
5033406	Hyundai	Coupe RD/Elantra (Lantra) J2	11/95-
5033407	Hyundai	Accent LC/Elantra XD	1/00-
5033408	Hyundai	Accent LC	1/00-
5033409	Hyundai	Atos MX	2/98-
5033410	Hyundai	H-1/Starex	6/97-
5033502	Kia	Pregio TB	10/97-
5033503	Kia	Pregio TB	10/97-
5033504	Kia	Sephia FA/Shuma FB	9/93-
5033513	Kia	Sephia FA/Shuma FB	9/93-
5033514	Kia	Sephia FA/Shuma FB	9/93-
5033603	Opel	Ascona B/Kadett C & Kadett City/Manta B	8/73-8/81
	Vauxhall	Cavalier/Chevette	1975-82
5033608	Opel	Kadett D	10/81-8/84
5033609	Opel	Kadett D	10/81-8/84
5033610	Opel	Ascona A/Manta A	10/70-8/75
5033611	Daewoo	Espero/Lanos/Nexia	2/95-
	Opel	Ascona C/Kadett E	9/81-2/93
	Vauxhall	Cavalier MK II	9/81-10/88
5033612	Daewoo	Espero/Lanos/Nexia	2/95-
	Opel	Ascona C/Kadett E	9/81-2/93
	Vauxhall	Cavalier MK II	9/81-10/88
5033613	Opel	Commodore A/Rekord C	8/66-12/71
5033614	Opel	Commodore A/Rekord C	8/66-12/71
5033615	Opel	Commodore B/Rekord D	1/72-7/78
5033616	Opel	Commodore B/Rekord D	1/72-7/78
5033617	Opel	Commodore B&C/Monza/ Rekord D&E/Senator A	1/72-8/87
	Vauxhall	Senator	9/84-8/87
5033618	Opel	Commodore C/Monza/ Rekord E/Senator A	8/77-8/87
	Vauxhall	Carlton MK II/Senator	1978-8/87

NK Nr./No.			
5033619	Opel	Commodore C/Monza/ Rekord E + Diesel/Senator A	8/77-8/87
	Vauxhall	Carlton MK II/Senator	1978-8/87
5033622	Daewoo	Espero/Lanos/Nexia	2/95-
	Opel	Ascona C/Kadett D&E	9/79-2/93
	Vauxhall	Cavalier MK II	9/81-10/88
5033623	Opel	Combo (Corsa)/Corsa/Tigra	9/82-
	Vauxhall	Combo (Corsa)/Corsa/Tigra	3/93-
5033626	Opel	Kadett B	11/68-7/73
5033627	Opel	Kadett C & Kadett City	8/73-8/79
	Vauxhall	Chevette	1975-82
5033628	Opel	Corsa A	9/82-3/93
5033637	Opel	Astra F/Calibra/Vectra A	9/88-
	Saab	9.3/900 II	7/93-
	Vauxhall	Astra MK III/Astravan MK III/ Cavalier MK III	9/88-3/01
5033638	Opel	Astra F/Calibra/Vectra A	9/88-
	Saab	9.3/900 II	7/93-
	Vauxhall	Astra MK III/Astravan MK III/ Cavalier MK III	9/88-3/01
5033639	Opel	Astra F/Calibra/Vectra A	9/88-
	Vauxhall	Astra MK III/Astravan MK III/ Cavalier MK III	9/88-3/01
5033640	Opel	Omega A/Senator B	8/86-5/94
	Vauxhall	Carlton MK III/Senator MK II	8/86-3/94
5033641	Opel	Omega A/Senator B	8/86-5/94
	Vauxhall	Carlton MK III/Senator MK II	8/86-3/94
5033642	Opel	Omega A/Senator B	8/86-5/94
	Vauxhall	Carlton MK III/Senator MK II	8/86-3/94
5033643	Opel	Omega A/Senator B	8/86-5/94
	Vauxhall	Carlton MK III/Senator MK II	8/86-3/94
5033644	Opel	Combo (Corsa)/Corsa B/Tigra	3/93-10/01
	Vauxhall	Combo (Corsa)/Corsa/Tigra	3/93-10/01
5033645	Opel	Combo (Corsa)/Corsa B/Tigra	3/93-10/01
	Vauxhall	Combo (Corsa)/Corsa/Tigra	3/93-10/01
5033646	Opel	Vectra B	10/95-
	Vauxhall	Vectra	10/95-
5033647	Opel	Vectra B	10/95-
	Vauxhall	Vectra	10/95-
5033648	Opel	Omega A/Senator B	8/86-5/94
	Vauxhall	Carlton MK III/Senator MK II	8/86-3/94
5033650	Opel	Omega B	3/94-7/03
	Vauxhall	Omega B	3/94-
5033651	Opel	Omega B	3/94-7/03
	Vauxhall	Omega B	3/94-
5033652	Opel	Omega B	3/94-7/03
	Vauxhall	Omega B	3/94-
5033653	Opel	Omega B	3/94-7/03
	Vauxhall	Omega B	3/94-
5033654	Opel	Vectra B	10/95-
	Vauxhall	Vectra	10/95-



Anvendelsesliste
Buyer's guide
Nummerische Liste

NK Nr./No.			
5033655	Opel	Astra G/Zafira	2/98-
	Vauxhall	Astra MK IV/ Astravan MK IV/Zafira	2/98-
5033656	Opel	Combo (Corsa)/Corsa B/Tigra	3/93-10/01
	Vauxhall	Combo (Corsa)/Corsa/Tigra	3/93-10/01
5033657	Opel	Agila H00	9/00-
	Vauxhall	Agila H00	9/00-
5033658	Opel	Agila H00	9/00-
	Vauxhall	Agila H00	9/00-
5033659	Opel	Agila H00	9/00-
	Vauxhall	Agila H00	9/00-
5033660	Opel	Astra G/Zafira	2/98-
	Vauxhall	Astra MK IV/ Astravan MK IV/Zafira	2/98-
5033661	Opel	Corsa C	9/00-
	Vauxhall	Corsa MK II	9/00-
5033701	Citroen	C15	10/84-12/97
	Peugeot	205	2/83-9/98
5033702	Citroen	Berlingo/C15/LN/LNA// Visa/Xsara/ZX	1976-
	Peugeot	104/205/306/309/504/ 505/604/Partner	4/78-
	Talbot	Samba/Tagora	2/81-12/87
5033706	Peugeot	309	10/85-12/93
5033711	Peugeot	305/405	7/84-10/96
5033712	Peugeot	305/405	7/84-10/96
5033713	Peugeot	405	5/87-10/96
5033714	Peugeot	505/604	5/79-12/93
5033717	Citroen	AX/Saxo/Xantia/XM	6/86-
	Peugeot	106 I&II/206/307/605	10/89-
5033718	Citroen	AX/Saxo/Xantia/XM	6/86-
	Peugeot	106 I&II/206/307/605	10/89-
5033719	Peugeot	306	3/93-
5033720	Citroen	XM (Y3/Y4)	3/89-10/00
	Peugeot	605	10/89-
5033721	Peugeot	406	10/95-
5033722	Peugeot	406	10/95-
5033723	Peugeot	406	10/95-
5033724	Peugeot	206	9/98-
5033725	Peugeot	307	10/01-
5033726	Peugeot	406	10/95-
5033727	Peugeot	605/607	10/89-
5033728	Peugeot	605/607	10/89-
5033729	Peugeot	605/607	10/89-
5033901	Renault	R18 R1340/R1341/R1349/ R1350/R1351/R4/R5/R6	5/78-12/93
5033903	Renault	Espace I&II/R5/R9/R11/ R14/Rapid	5/76-3/98
5033904	Renault	R5 (Super 5)	10/84-12/96
5033910	Renault	Trafic	9/80-3/01



NK Nr./No.			
5033913	Renault	R19	11/88-1996
5033914	Renault	R19	11/88-1996
5033915	Renault	Clio I	1/91-4/96
5033916	Renault	Clio I	1/91-4/96
5033917	Renault	Clio I	1/91-4/96
5033918	Renault	Twingo	3/93-
5033919	Renault	Twingo	3/93-
5033920	Renault	Twingo	3/93-
5033921	Renault	R19	11/88-1996
5033922	Renault	Laguna	11/93-3/01
5033923	Renault	Laguna	11/93-3/01
5033924	Renault	Espace II J63#	1/91-10/96
5033925	Renault	Safrane	4/92-12/00
5033926	Renault	Safrane	4/92-12/00
5033927	Renault	Clio I	4/96-9/98
5033928	Renault	Clio I	4/96-9/98
5033929	Renault	Clio I	4/96-9/98
5033930	Renault	Laguna	11/93-3/01
5033931	Renault	Clio II	9/98-
5033932	Renault	Clio II	9/98-
5033933	Renault	Clio II	9/98-
5033934	Renault	Kangoo	2/98-
5033935	Renault	Kangoo	2/98-
5033936	Renault	Clio II	9/98-
5033937	Renault	Clio II/Kangoo	2/98-
5033938	Renault	Megane I	1/96-
5033939	Renault	Megane I	1/96-
5033940	Renault	Megane I	1/96-
5033941	Opel	Movano	7/98-
	Renault	Master II	7/98-
	Vauxhall	Movano	7/98-
5033942	Opel	Movano	7/98-
	Renault	Master II	7/98-
	Vauxhall	Movano	7/98-
5033943	Opel	Movano	7/98-
	Renault	Master II	7/98-
	Vauxhall	Movano	7/98-
5033945	Renault	Clio II/Kangoo/Megane I/ Scenic (JA)	1/96-
5033946	Renault	Clio II/Kangoo/Megane I/ Scenic (JA)	1/96-
5033947	Renault	Espace III JE_	11/96-
5033948	Renault	Espace III JE_	11/96-
5033949	Renault	Espace III JE_	11/96-
5033950	Renault	Kangoo	2/98-
5033951	Renault	Megane I/Scenic (JA)	1/96-
5033952	Renault	Megane I/Scenic (JA)	1/96-
5033958	Renault	Kangoo	1/96-
5033959	Renault	Megane I/Scenic (JA)	1/96-
5033960	Renault	Megane I/Scenic (JA)	1/96-
5034001	Honda	Concerto HW	8/89-3/95
	Rover Group	Rover 214/216/218/220/ 414/416/418/ 420	10/89-

Anvendelsesliste
Buyer's guide
Nummerische Liste

NK Nr./No.			
5034003	Jeep	Grand Cherokee 5.2	1/92-4/99
5034004	Rover Group	Landrover Defender/ Landrover Discovery I	9/89-
5034005	Rover Group	Landrover Defender/ Landrover Discovery I	9/89-
5034008	Jeep	Wrangler	1/88-
5034009	Jeep	Wrangler	1/88-
5034010	Rover Group	Mini One & Cooper	6/01-
5034011	Rover Group	Mini One & Cooper	6/01-
5034012	Rover Group	Mini One & Cooper	6/01-
5034017	Land Rover	Freelander	2/98-
5034018	Land Rover	Freelander	2/98-
5034101	Saab	95/96	10/65-8/80
5034103	Saab	90/900 I/99	10/74-6/94
5034105	Saab	9000	9/84-12/98
5034106	Saab	900 I	11/78-6/94
5034107	Saab	900 I	11/78-6/94
5034108	Saab	9000	9/84-12/98
5034113	Saab	9.5	9/97-
5034301	Skoda	100/105/110/120/130	1969-10/91
5034305	Skoda	Favorit/Felicia/Forman	5/89-
5034306	Skoda	Favorit/Felicia/Forman	5/89-
5034307	Seat	Cordoba/Ibiza	1/02-
	Skoda	Fabia	12/99-
	Volkswagen	Polo (9N_)	10/01-
5034308	Seat	Cordoba/Ibiza	2/02-
	Skoda	Fabia	12/99-
	Volkswagen	Polo (9N_)	10/01-
5034309	Skoda	Fabia	12/99-
	Volkswagen	Polo (9N_)	10/01-
5034401	Subaru	Justy	11/84-10/95
5034402	Subaru	Justy	11/84-10/95
5034501	Daihatsu	Charmant A35/A55/A60	10/81-7/87
	Toyota	Corolla/Starlet	2/78-1/88
5034502	Toyota	Corolla/Starlet/Tercel	2/78-1/88
5034508	Toyota	Corolla/Tercel	5/82-
5034512	Toyota	Carina/Celica/Corolla/Liteace	75/1987
5034520	Toyota	Carina/Corolla/MR2/Paseo	5/83-7/99
5034521	Toyota	Camry SV10/SV11/CV10	3/82-10/86
5034526	Toyota	4 Runner/Dyna/Hiace/Hilux	8/78-
	Volkswagen	Taro	4/89-3/97
5034535	Toyota	Camry/Carina/Celica/ Corolla/Rav4	10/83-1/02
5034541	Toyota	Carina/Corolla	5/83-5/88
5034543	Toyota	Carina/Corolla	5/83-5/88
5034552	Toyota	CorollaAE92/AE95/EE90/CE90	5/87-6/93
5034553	Toyota	Camry SV10/SV11/CV10	3/82-10/86
5034554	Toyota	Camry/Celica	8/85-5/91
5034557	Toyota	Landcruiser RJ70/LJ70/LJ71	11/84-12/89
5034558	Toyota	Liteace/Model F Sportsvan	8/85-7/88
5034559	Toyota	CorollaAE92/AE95/EE90/CE90	5/87-6/93
5034560	Toyota	Carina I/AT17#/ST17#/CT17#	12/87-6/93

NK Nr./No.			
5034561	Toyota	Carina I/AT17#/ST17#/CT17#	12/87-6/93
5034562	Toyota	Carina I/AT17#/ST17#/CT17#	12/87-6/93
5034563	Toyota	Carina I/AT17#/ST17#/CT17#	12/87-6/93
5034564	Toyota	Carina E/Picnic	2/92-
5034565	Toyota	Carina E/Picnic	2/92-
5034567	Toyota	Carina E AT19#/ST 19#/CT19#	2/92-9/97
5034570	Toyota	CorollaAE10#/EE10#/CE10#	5/92-4/97
5034571	Toyota	MR2/Starlet	12/89-
5034573	Toyota	Hiace	8/89-
5034574	Toyota	Hiace	8/89-
5034575	Toyota	Liteace/Model F Sportsvan	8/88-1/92
5034576	Toyota	Liteace/Model F Sportsvan	8/88-1/92
5034577	Toyota	Camry SXV10/VCV10/ SXV20/VCV20	6/91-11/01
5034578	Toyota	Landcruiser	10/81-12/89
5034581	Toyota	Avensis/Carina E	2/92-
5034582	Toyota	Avensis/Carina E	2/92-
5034583	Toyota	Carina E AT19#/ST19#/CT19#	2/92-9/97
5034584	Toyota	Yaris _CP10 / Yaris Verso NC/LP	4/99-
5034585	Toyota	Previa	5/90-8/00
5034586	Toyota	Previa	5/90-8/00
5034587	Toyota	Yaris _CP10 / Yaris Verso NC/LP	4/99-
5034588	Toyota	Yaris _CP10 / Yaris Verso NC/LP	4/99-
5034709	Volkswagen	1200/1300/1500/1600/ Tranporter T2	5/68-
5034712	Audi	50/80/Coupe III	5/72-10/88
	Volkswagen	Derby/Polo	4/75-8/94
5034714	Volkswagen	Caddy I/Golf I/Jetta I/ Scirocco/Transporter T3	2/74-7/92
5034715	Volkswagen	Caddy I/Golf I/Jetta I/ Scirocco	2/74-7/92
5034716	Seat	Arosa/Cordoba/Ibiza/Toledo	3/91-
	Volkswagen	Corrado/Golf II&III/Jetta II/ Lupo/Passat/Polo/Vento	8/83-
5034717	Seat	Cordoba/Ibiza/Toledo	3/91-10/02
	Volkswagen	Golf II/Jetta II	8/83-12/92
5034720	Audi	80/90/Cabriolet/Coupe	4/80-
	Volkswagen	Passat/Santana	8/80-88
5034723	Volkswagen	LT 28/31/35	4/75-4/96
5034724	Volkswagen	LT 28/31/35	4/75-4/96
5034725	Volkswagen	LT 28/31/35	4/75-4/96
5034728	Audi	100	7/77-7/91
5034729	Audi	100	7/77-7/91
5034730	Audi	100/200/A6/V8	7/77-12/97
5034731	Audi	100/200/A6/V8	7/77-12/97
5034732	Volkswagen	LT 28/31/35	4/75-4/96
5034733	Volkswagen	LT 28/31/35	4/75-4/96
5034734	Volkswagen	Golf III/Vento	11/91-4/99

Anvendelsesliste
Buyer's guide
Nummerische Liste

NK Nr./No.			
5034735	Seat	Arosa/Cordoba/Ibiza/Toledo	3/91-
	Volkswagen	Corrado/Golf II&III/Jetta II/ Lupo/Passat/Polo/Vento	1/84-
5034737	Volkswagen	Passat	2/88-5/97
5034738	Volkswagen	Transporter T4	7/90-12/95
5034739	Volkswagen	Transporter T4	7/90-12/95
5034740	Volkswagen	Transporter T4	7/90-12/95
5034741	Volkswagen	Transporter T4	7/90-
5034742	Audi	100	12/90-6/94
5034743	Audi	100	12/90-6/94
5034746	Volkswagen	Golf III/Vento	11/91-4/99
5034747	Volkswagen	Passat	2/88-5/97
5034749	Volkswagen	Transporter T4	7/90-12/95
5034750	Volkswagen	Transporter T4	7/90-12/95
5034751	Volkswagen	Transporter T4	7/90-12/95
5034752	Volkswagen	Transporter T4	7/90-12/95
5034753	Audi	A3 (8L1)	6/96-
	Seat	Leon	11/99-
	Skoda	Octavia (1U2 & 1U5)	9/96-
	Volkswagen	Golf IV	8/97-
5034754	Audi	A3 (8L1)	6/96-
	Seat	Leon	11/99-
	Skoda	Octavia (1U2 & 1U5)	9/96-
	Volkswagen	Golf IV	8/97-
5034755	Audi	A4/A6/A8	3/94-
	Volkswagen	Passat	8/96-
5034756	Audi	A4/A6/A8	3/94-
	Volkswagen	Passat	8/96-
5034757	Audi	A3 (8L1)	6/96-
	Seat	Ibiza/Leon/Toledo II	4/99-
	Skoda	Octavia (1U2 & 1U5)	9/96-
	Volkswagen	Bora/Golf IV/New Beetle	8/97-
5034759	Volkswagen	Lupo	4/97-
5034760	Volkswagen	Lupo	4/97-
5034761	Volkswagen	Lupo	4/97-
5034762	Volkswagen	Polo	10/94-9/01
5034763	Seat	Cordoba/Ibiza/Inca/Toledo	3/91-
	Volkswagen	Caddy II/Passat/Polo	2/88-
5034764	Seat	Cordoba/Ibiza/Inca/Toledo	3/91-
	Volkswagen	Caddy II/Passat/Polo	2/88-
5034767	Volkswagen	Transporter T4	1/96-
5034768	Volkswagen	Transporter T4	1/96-
5034769	Audi	A3 (8L1)	6/96-
	Seat	Toledo II	4/99-
	Skoda	Octavia (1U2 & 1U5)	9/96-
	Volkswagen	Bora/Golf IV/New Beetle	8/97-
5034770	Audi	A3 (8L1)	6/96-
	Seat	Toledo II	4/99-
	Skoda	Octavia (1U2 & 1U5)	9/96-
	Volkswagen	Bora/Golf IV/New Beetle	8/97-
5034771	Audi	A2 (8Z0)	2/00-8/05

NK Nr./No.			
5034772	Seat	Cordoba/Ibiza/Inca/Toledo	3/91-
5034773	Volkswagen	Passat	2/88-5/97
5034774	Audi	A2 (8Z0)	2/00-8/05
5034803	Volvo	340/343/345/360	2/76-7/91
5034804	Volvo	340/343/345/360	2/76-7/91
5034805	Volvo	240/260/740/760/780/940/960	8/74-10/98
5034806	Volvo	240/260	8/74-7/93
5034807	Volvo	240/260	8/74-7/93
5034808	Volvo	440/460/480	4/86-12/96
5034809	Volvo	440/460/480	4/86-12/96
5034811	Volvo	240/260	8/74-7/93
5034812	Volvo	240/260	8/74-7/93
5034813	Volvo	340/343/345/360	2/76-7/91
5034814	Volvo	440/460/480	4/86-12/96
5034815	Volvo	740/760/780	8/82-7/92
5034816	Volvo	740/760/780	8/82-7/92
5034817	Volvo	850/C70/S70/S60/S80/ S90/V70/V90	6/91-
5034818	Volvo	850/C70/S70/S60/S80/ S90/V70/V90	6/91-
5034820	Volvo	S40/V40	7/95-
5034821	Volvo	S40/V40	7/95-
5035001	Daewoo	Matiz/Tico	2/95-
5035002	Daewoo	Leganza/Nubria	6/97-
5035003	Daewoo	Leganza/Nubria	6/97-
5035004	Daewoo	Matiz	9/98-
5035109	Daihatsu	Applause/Charade/Move	2/87-
5035110	Daihatsu	Applause/Charade/Move	2/87-
5035111	Daihatsu	Charade	2/87-1/93
5035201	Suzuki	Samurai/Vitara	7/88-
5035202	Suzuki	Alto II & III	1/86-6/02
5035203	Suzuki	Baleno/Swift	10/84-
5041002	Alfa Romeo	Alfa 33/Arna	7/83-9/94
5041004	Alfa Romeo	75/90/Alfetta/Giulietta	1972-2/92
5041005	Alfa Romeo	75/90/Alfetta/Giulietta	1972-2/92
5041006	Alfa Romeo	GTV/Spider	6/95-
5041201	Rover Group	Mini 850/1000, Clubman & Cooper	1959-
5041202	Rover Group	Metro	10/80-
5041502	BMW	3-Series (E30)	7/87-10/93
5041503	BMW	3-Series (E30)	7/87-10/93
5041505	BMW	3-Series (E36)/Z3	9/90-
5041506	BMW	3-Series (E36)/Z3	9/90-
5041512	BMW	325 iX (E30)	3/86-10/93
5041513	BMW	325 iX (E30)	3/86-10/93
5041515	BMW	X5 (E53)	2/02-
5041801	Talbot	1100/1307/1308/1309/ 1510/Horizon/Solara	1972-7/86
5041802	Talbot	1100/Horizon	1972-6/86
5041803	Talbot	1307/1308/1309/1510/Solara	1975-7/86
5041901	Citroen	C15/LN/LNA/Visa	1976-12/97

Anvendelsesliste
Buyer's guide
Nummerische Liste

NK Nr./No.			
	Peugeot	104	3/79-6/88
	Renault	R14	5/76-12/83
	Talbot	Samba	1982-6/86
5041909	Citroen	AX	6/86-12/98
5041912	Citroen	C5/Xantia/XM	3/89-
	Peugeot	405/406/605/607	5/87-
5041914	Citroen	Jumper 230	2/94-4/02
	Fiat	Ducato	3/94-4/02
	Peugeot	Boxer (230)	3/94-4/02
5041915	Citroen	Jumper 230	2/94-4/02
	Fiat	Ducato	3/94-4/02
	Peugeot	Boxer (230)	3/94-4/02
5041916	Citroen	Berlingo/Xsara/ZX	3/91-
	Peugeot	405/Partner	5/87-
5041917	Citroen	Berlingo/Xsara/ZX	3/91-
	Peugeot	405/Partner	5/87-
5041918	Citroen	Berlingo/Xsara	10/96-
	Peugeot	Partner	6/96-
5041919	Citroen	Berlingo/Xsara	10/96-
	Peugeot	Partner	6/96-
5041920	Citroen	C3	2/02-
5041921	Citroen	Jumper 230/244	2/94-
	Fiat	Ducato	3/94-
	Peugeot	Boxer 230/244	3/94-
5041922	Citroen	Jumper 230/244	3/94-
	Fiat	Ducato	3/94-
	Peugeot	Boxer (230/244)	3/94-
5042202	Nissan	Cherry FII N10	10/78-12/83
5042203	Nissan	Cherry/Prairie/Sunny	3/82-1988
5042210	Ford	Maverick	2/93-4/98
	Nissan	280/King Cab/King Van/ Terrano/Urvan/Vanette	1/79-
5042216	Nissan	King Cab/King Van/Urvan	9/79-11/88
5042220	Ford	Maverick	2/93-4/98
	Nissan	King Cab/Terrano	4/83-
5042221	Nissan	Bluebird 910	10/79-5/84
5042223	Nissan	Sunny II	6/86-8/91
5042225	Nissan	King Cab/King van/Urvan	8/85-
5042226	Nissan	Vanette C22 2WD	5/86-12/95
5042227	Nissan	Vanette	6/81-12/95
5042228	Nissan	Primera	6/90-
5042229	Nissan	Bluebird/Maxima/ Prairie/Primera	4/84-3/98
5042230	Nissan	100 NX/Almera/Sunny	3/90-
5042231	Nissan	Micra K11	8/92-2/03
5042232	Nissan	Serena/Vanette	11/92-
5042233	Nissan	Serena/Vanette	11/92-
5042301	Fiat	132/Argenta	1972-7/86
	Polski Fiat	Polonez	1981-
5042302	Fiat	132/Argenta	1972-7/86



NK Nr./No.			
	Polski Fiat	Polonez	1981-
5042303	Fiat	Panda/Uno	3/80-
	Lancia	Y 10	3/85-12/95
	Seat	Marbella/Terra	1980-
5042306	Fiat	Daily	1/78-
5042307	Lada	1200/1300/1500/1600/Niva	1972-1/87
5042308	Lada	1200/1300/1500/1600	1972-1/87
5042309	Citroen	C 25	9/81-3/94
	Fiat	Ducato/Talento	5/81-3-94
	Peugeot	J5	9/81-1994
5042310	Citroen	C 25	9/81-3/94
	Fiat	Ducato	5/81-3-94
	Peugeot	J5	9/81-1994
5042311	Alfa Romeo	Alfa 164	6/87-9/98
	Fiat	Croma	4/86-12/96
	Lancia	Thema (834)	3/86-7/94
5042312	Lada	Samara	3/85-
5042313	Fiat	Panda/Uno	3/80-
	Lancia	Y 10	3/85-12/95
	Seat	Marbella	1980-
5042314	Fiat	Panda	3/80-
	Lancia	Y 10	3/85-12/95
	Seat	Marbella	1980-
5042315	Fiat	Palio/Siena	4/96-
5042318	Lancia	Kappa	8/94-
5042319	Fiat	Dobló	3/01-
5042320	Fiat	Dobló	3/01-
5042501	Ford	Fiesta I	5/76-8/83
5042502	Ford	Fiesta II	8/83-4/89
5042503	Ford	Escort MK. III	9/80-12/85
5042506	Ford	Cortina MK III/Taurus	1970-82
5042507	Ford	Cortina MK III/Taurus	1970-82
5042508	Ford	Consul/Granada	3/72-8/85
5042509	Ford	Consul/Granada	3/72-8/85
5042510	Ford	Transit	10/85-9/92
5042513	Ford	Econovan	3/86-3/92
5042514	Ford	Escort/Fiesta/Orion	5/89-7/00
5042515	Ford	Fiesta	1/92-12/93
5042516	Ford	Fiesta/Ka/Puma	1/94-
	Mazda	121 JA/JB	3/96-
5042517	Ford	Cougar/Mondeo I&II	2/93-
5042518	Ford	Transit	10/85-3/00
5042520	Ford	Focus	10/98-
5042522	Ford	Fiesta	11/01-
5042523	Ford	Mondeo III	11/00-
5042524	Ford	Transit	3/00-
5042602	Honda	Accord III/Civic/Prelude	2/83-2/92
5042603	Honda	Accord/Shuttle	1/90-5/01
5042604	Honda	Civic/CR-V/Integra	10/91-
5042605	Honda	Prelude BB	2/92-
5042607	Honda	Accord VII	1/01-

Anvendelsesliste
Buyer's guide
Nummerische Liste

NK Nr./No.		
5043001	Mitsubishi Colt I/Lancer F II	12/78-1/84
5043002	Mitsubishi Colt I/Lancer F II	12/78-1/84
5043003	Mitsubishi Galant/Lancer	5/76-6/92
5043006	Mitsubishi L 200/L300	8/80-8/96
5043007	Hyundai H100	7/93-3/00
	Mitsubishi L 200/L300/Pajero	8/80-8/96
5043008	Mitsubishi L 200/L300/Pajero	8/80-8/96
5043009	Mitsubishi Carisma/Colt/Cordia/Galant/Lancer/Sapporo/Sigma/Space Runner/Space Star/Space Wagon/Tredia	4/78-
	Volvo S40/V40	7/95-
5043010	Mitsubishi L 300 2WD PO1V, PO2V, PO5V, P12V, P15V, PO3W, PO5W, P15W	6/86-
5043011	Hyundai H100	7/93-3/00
	Mitsubishi L 300	6/86-
5043012	Mitsubishi Pajero II&III	12/90-
5043013	Mitsubishi Pajero II&III	12/90-
5043014	Mitsubishi Pajero II V-Serie	12/90-4/00
5043201	Mazda 323 I	11/76-5/86
5043202	Mazda 323 II BD	8/80-12/85
5043204	Mazda 626	11/82-9/97
5043205	Mazda 929	10/72-8/77
5043210	Mazda B 1800/B 2000/B 2200	10/81-8/95
5043212	Mazda 323 III	5/85-3/93
5043213	Ford Econovan	3/86-3/92
	Kia Besta	2/96-
	Mazda E 2000/E2200	5/83-
5043214	Kia Besta	2/96-
	Mazda E 2000/E2200	5/83-
5043215	Mazda 323 IV BG	9/89-10/94
5043216	Mazda B2000/B2200/B2600	1/85-6/99
5043217	Mazda B 2000/B2200	1/85-12/96
5043219	Mazda 323 IV&V	9/89-9/98
5043303	MB 200/220/230/240/D W115/230/250/280 C/CE W114	1968-12/75
5043304	MB C123/T123/W123/C126/W126	1976-6/91
5043305	MB W124/W201	11/84-3/98
5043307	MB W140	2/91-2/99
5043308	MB W202/W208/W210	3/93-
5043309	MB W 168 A-Klasse	7/97-
5043310	MB MB 100 (631)	2/88-2/96
5043311	MB Sprinter	2/95-
	Volkswagen LT 28-35 II, LT 28-46 II	5/96-
5043312	MB W163 ML	2/98-
5043314	MB Vito (638)/V-klasse (638/2)	2/96-
5043401	Hyundai Accent X3/Sonata I Y2	9/88-01/00
5043402	Hyundai Elantra (Lantra) J1	10/90-10/95
5043403	Hyundai Coupe RD/Elantra (Lantra) J2	11/95-



NK Nr./No.		
5043404	Hyundai Accent X3/Coupe RD/Excel/Pony X2/S Coupe	1/90-4/02
5043405	Hyundai Accent/Elantra	1/00-
5043406	Hyundai Atos MX	2/98-
5043501	Kia Carens I	2/96-7/02
5043502	Kia Pregio TB	10/97-
5043503	Kia Sephia FA/Shuma FB	9/93-
5043504	Kia Sephia FA/Shuma FB	9/93-
5043602	Opel Kadett B	11/68-7/73
5043603	Opel Kadett B	11/68-7/73
5043604	Opel Kadett C & Kadett City	8/73-8/79
	Vauxhall Chevette	1975-82
5043605	Opel Kadett C & Kadett City	8/73-8/79
	Vauxhall Chevette	1975-82
5043606	Opel Kadett D	9/79-9/81
5043607	Daewoo Espero/Lanos/Leganza/Nexia	2/95-
	Opel Kadett D&E	10/81-2/93
5043608	Opel Ascona A/Manta A	10/70-8/75
5043610	Opel Ascona B/Manta B	9/75-8/81
	Vauxhall Cavalier	1975-8/81
5043611	Opel Ascona B/Manta B	9/75-8/81
	Vauxhall Cavalier	1975-8/81
5043612	Opel Ascona C/Astra F/Calibra/Vectra A	9/81-
	Vauxhall Astra MK III/Astravan MK III/ Cavalier MK II&III	9/81-3/01
5043620	Opel Commodore C/Monterey A&B/ Monza/Rekord E&D/Senator A	8/77-8/99
	Vauxhall Carlton MK II/Monterey/Senator	1978-8/99
5043622	Opel Combo (Corsa)/Corsa A&B/Tigra	9/82-10/01
	Vauxhall Combo (Corsa)/Corsa/Tigra	3/93-
5043625	Opel Omega A/Senator B	8/86-5/94
	Vauxhall Carlton MK III/Senator MK II	8/86-3/94
5043626	Opel Omega A/Senator B	8/86-5/94
	Vauxhall Carlton MK III/Senator MK II	8/86-3/94
5043627	Opel Astra G/Omega B/Vectra B/Zafira	3/94-
	Vauxhall Astra MK IV/Astravan MK IV/Omega B/Vectra/Zafira	3/94-
5043628	Opel Vectra B	10/95-
	Vauxhall Vectra	10/95-
5043629	Opel Combo (Corsa)/Corsa B/Tigra	3/93-10/01
	Vauxhall Combo (Corsa)/Corsa/Tigra	3/93-
5043630	Opel Campo/Frontera A	8/91-
	Vauxhall Frontera	3/92-10/98
5043631	Opel Campo/Frontera A&B/Monterey A&B	8/91-
	Vauxhall Frontera/Frontera MK II/	9/91-

Anvendelsesliste
Buyer's guide
Nummerische Liste

NK Nr./No.		
	Monterey	
5043632	Opel Corsa C	9/00-
	Vauxhall Corsa MK II	9/00-
5043702	Peugeot 504/505/604	5/79-12/93
	Talbot Tagora	2/81-12/87
5043705	Citroen BX & BX Break	9/82-12/94
	Peugeot 305/405	7/84-10/96
5043706	Citroen AX/Saxo	6/86-
	Peugeot 106 I & II	9/91-
5043707	Peugeot 306	3/93-
5043708	Peugeot 306	3/93-
5043710	Peugeot 306	4/97-
5043711	Peugeot 306	4/97-
5043712	Peugeot 307	10/01-
5043901	Renault R4/R5/R6	1968-12/93
5043902	Renault R4/R5/R6	1968-12/93
5043903	Renault R4/R5/R6	1968-12/93
5043904	Renault R4/R5/R6	5/78-12/93
5043905	Renault R4/R5/R6	5/78-12/93
5043907	Dacia 1210/1310	5/83-
	Renault R12/R15/R17/R18 R1340/ R1341/R1349/R1350/R1351	9/69-1982
5043916	Renault Trafic	9/80-3/01
5043919	Renault Clio/Kangoo/Megane/R5/ R9/R19/Rapid/Scenic/Twingo	9/81-
5043920	Renault Laguna	11/93-3/01
5043921	Renault Safrane	4/92-12/00
5043922	Renault Megane	1/96-
5043923	Renault Megane	1/96-
5043924	Renault Master I	8/80-7/98
5043925	Renault Master I	8/80-7/98
5043926	Opel Movano	7/98-
	Renault Master II/Trafic	7/98-
	Vauxhall Movano	7/98-
5043927	Renault Espace II J63#	1/91-10/96
5043928	Renault Espace II J63#	1/91-10/96
5043929	Renault Espace III JE_	11/96-
5043930	Opel Movano	7/98-
	Renault Master II/Trafic	7/98-
	Vauxhall Movano	7/98-
5044001	Rover Group Mini One & Cooper	6/01-
5044010	Rover Group Landrover	9/89-
5044013	Jeep Cherokee	1/88-
5044014	Jeep Cherokee	1/88-
5044015	Land Rover Freelander	2/98-
5044101	Saab 95/96	10/65-8/80
5044102	Saab 90/900 I/99/	1968-6/94
5044103	Saab 9000	9/84-12/98
5044105	Saab 9.5	9/97-

NK Nr./No.		
5044301	Skoda Favorit/Felicia/Forman	5/89-
5044303	Skoda Fabia	12/99-
	Volkswagen Polo (9N_)	10/01-
5044304	Skoda Fabia	12/99-
	Volkswagen Polo (9N_)	10/01-
5044401	Subaru Forester SF/Impreza/Legazy	1/89-
5044402	Subaru Justy	11/84-10/95
5044501	Toyota Tercel AL11	8/78-7/82
5044502	Toyota Corolla/MR2/Tercel	5/82-
5044504	Daihatsu Charmant A35/A55/A60	10/81-7/87
	Toyota Carina/Celica/Corolla	1975-1/88
5044505	Toyota Carina/Corolla	5/83-5/88
5044506	Toyota Camry	3/82-5/91
5044512	Toyota Dyna 100/Hiace	12/82-
5044514	Toyota Dyna 100/Hiace	12/82-
5044518	Toyota Hilux	3/83-
5044519	Toyota Hilux LN5#/YN5# 2WD	3/83-8/88
5044522	Toyota Liteace/Model F Sports Van	10/82-1/92
5044523	Toyota Liteace/Model F Sports Van	10/82-1/92
5044525	Toyota CorollaAE92/AE95/EE90/CE905/87-6/93	
5044526	Toyota CorollaAE92/AE95/EE90/CE905/87-6/93	
5044527	Toyota Carina II/Celica	8/85-6/93
5044528	Toyota Avensis/Carina E/ Corolla/Rav 4	2/92-
5044531	Toyota Hiace LH10# / LH11# / RZH10# / RZH11#	8/89-8/95
5044532	Toyota Hilux LN8#/YN8#/LN9#/RN9#	8/88-
	Volkswagen Taro	4/89-3/97
5044533	Toyota 4 Runner/Hilux	5/85-
	Volkswagen Taro	4/89-3/97
5044534	Toyota 4 Runner/Hilux	8/88-
	Volkswagen Taro	4/89-3/97
5044535	Toyota Starlet EP7 Serie	10/84-12/89
5044536	Toyota Corolla/Prius/Rav 4	4/97-
5044537	Toyota Previa	5/90-8/00
5044538	Toyota Yaris_CP10 / Yaris Verso NC/LP	4/99-
5044701	Volkswagen 1200/1300/1500 Type 1	8/65-
5044702	Volkswagen 1200/1300/1500 Type 1	8/65-
5044703	Volkswagen 1302/1302 S Type 1	8/70-7/72
5044704	Volkswagen 1303/1303 S Type 1	8/72-1/80
5044708	Volkswagen Caddy I/Golf I/Jetta I/Scirocco	2/74-8/93
5044709	Volkswagen Caddy I/Golf I/Jetta I/Scirocco	2/74-8/93
5044710	Volkswagen Golf II/Jetta II	8/83-12/92
5044711	Audi 80/90	9/77-
	Volkswagen Passat/Santana	7/73-88
5044714	Volkswagen Transporter T3	5/79-7/92
5044715	Volkswagen Transporter T3	5/79-7/92
5044716	Volkswagen LT 28/31/35 & LT 40/45/50	4/75-5/96
5044717	Volkswagen LT 28/31/35 & LT 40/45/50	4/75-5/96
5044720	Seat Cordoba/Ibiza/Inca/Toledo	3/91-



Anvendelsesliste
Buyer's guide
Nummerische Liste

NK Nr./No.		
	Volkswagen Caddy II/Corrado/Golf II&III/ Jetta II/Passat/Polo/Vento	8/83-
5044721	Audi 80/90/Coupe	8/80-7/91
5044722	Audi 80/Coupe	8/80-7/89
5044723	Audi 80/90	9/86-8/91
5044724	Audi 80/90	9/86-8/91
5044725	Volkswagen Transporter T4	7/90-
5044726	Volkswagen Transporter T4	7/90-12/95
5044729	Audi 80/Cabriolet/Coupe	8/89-
5044730	Audi 80/Cabriolet/Coupe	8/89-
5044731	Seat Arosa	5/97-
	Volkswagen Lupo/Polo	10/94-
5044732	Seat Arosa	5/97-
	Volkswagen Lupo/Polo	10/94-
5044733	Ford Galaxy	11/95-
	Seat Alhambra	4/96-
	Volkswagen Sharan (7M)	5/95-
5044734	Volkswagen Golf III/Vento	11/91-4/99
5044735	Audi 80/90	9/86-9/91
	Volkswagen Passat/Santana	8/80-88
5044736	Audi 80/90	9/86-9/91
	Volkswagen Passat/Santana	8/80-88
5044738	Audi A3 (8L1)	6/96-
	Seat Ibiza/Leon/Toledo II	4/99-
	Skoda Octavia (1U2 & 1U5)	9/96-
	Volkswagen Bora/Golf IV/New Beetle	8/97-
5044739	Audi A3 (8L1)	6/96-
	Seat Ibiza/Leon/Toledo II	4/99-
	Skoda Octavia (1U2 & 1U5)	9/96-
	Volkswagen Bora/Golf IV/New Beetle	8/97-
5044740	Audi 80/90	9/86-9/91
5044741	Audi 80/90	9/86-9/91
5044742	Volkswagen Transporter T4	1/96-
5044802	Volvo 340/343/345/360	2/76-7/91
5044803	Volvo Amazone 121/122	1959-70
5044804	Volvo Amazone 121/122	1959-70
5044805	Volvo 142/144/145/164	8/68-7/74
5044807	Volvo 142/144/145/164	8/68-7/74
5044808	Volvo 240/260 Series	8/74-7/93
5044809	Volvo 240/260 Series	8/74-7/93
5044810	Volvo 240/260 Series	8/74-7/93
5044811	Volvo 740/760/780/940/ S90/V90 Series	4/84-12/98
5044812	Volvo 440/460/480	4/86-12/96
5044813	Volvo S60/S80/V70 II	6/98-
5045001	Daewoo Nubria	5/97-
5071901	Citroen 2 CV/Acadiane/Ami 6/ 8/Dyane 4/6/Mehari	1959-
5073304	MB 207 D/208/307D/308	
5091004	Alfa Romeo Alfa 155/GTV/Spider	2/92-



NK Nr./No.		
5091005	Alfa Romeo 147/156/166	11/97-
5091006	Alfa Romeo 145/146	10/94-1/01
5091201	Rover Group Allegro/Mini 850/1000, Clubman & Cooper	1959-
5091501	BMW 3-Series (E21)&(E30)	8/75-6/94
5091502	BMW 3-Series (E21)&(E30)	8/75-6/94
5091503	BMW 3-Series (E30)	9/82-10/93
5091504	BMW 3-Series (E30)/Z1	9/82-10/93
5091505	BMW 3-Series (E36)/ 5-Series (E34)/Z3	1/88-
5091506	BMW 3-Series (E46)	3/98-
5091507	BMW 5-Series (E39)	11/95-
5091803	Talbot 1307/1308/1309/1510/ Horizon/Solara	1975-7/86
5091906	Citroen AX/Saxo	6/86-
5091907	Citroen ZX	3/91-1997
5091908	Citroen ZX	3/91-1997
5091909	Citroen XM	3/89-10/00
	Peugeot 405/605	5/87-
5091910	Citroen C 25	9/81-3/94
	Fiat Talento	5/88-3/94
	Peugeot J5	9/81-1994
5091911	Citroen Xsara	4/97-
5091915	Citroen Xantia	3/93-
5091916	Citroen Xantia	3/93-
5092203	Nissan Bluebird/Micra/Sunny	12/82-7/92
5092204	Nissan Bluebird/Primera	12/85-3/98
5092205	Nissan Primera	6/90-
5092206	Nissan Almera I&II	9/95-
5092207	Nissan Micra K11	8/92-2/03
5092208	Nissan Serena C23M	11/92-
5092301	Fiat 126/127/128/131/147/ Duna/Fiorino/Panda/Uno	1971-
5092301	Lancia A 112/Y 10	1970-12/95
	Seat Ibiza/Malaga	5/85-12/93
	Skoda Favorit/Forman	5/89-6/95
	Yugo 101	1972-93
5092308	Fiat Tempra/Tipo	11/87-8/96
5092309	Fiat Cinquecento/Seicento	7/91-
5092310	Fiat Brava/Bravo/Punto/Ritmo/ Tempra/Tipo	6/83-10/01
	Lancia Dedra	4/89-7/99
5092311	Fiat Barchetta/Brava/Bravo/ Coupe/Marea/Palio/Punto/ Siena/Strada	9/93-
5092312	Lada Samara	3/85-
5092313	Seat Cordoba/Ibiza/Toledo	3/91-10/02
	Volkswagen Corrado/Golf III/Passat/ Santana/Scirocco	2/80-4/99
5092314	Fiat Ulysse (220)	6/94-8/02
	Lancia Zeta	5/95-9/02



Anvendelsesliste
Buyer's guide
Nummerische Liste

NK Nr./No.			
5092315	Fiat	Ducato	5/81-4/02
5092316	Ford	Galaxy	11/95-
	Seat	Alhambra	4/96-
	Volkswagen	Sharan (7M)	5/95-
5092318	Fiat	Ducato	3/94-4/02
5092319	Citroen	Jumper 230	2/94-4/02
	Fiat	Ducato	3/94-4/02
	Peugeot	Boxer (230)	3/94-4/02
5092320	Fiat	Multipla	4/99-
5092501	Ford	Escort MK.III/Fiesta I&II	5/76-4/89
5092503	Ford	Capri MK I / MK II / MK III/ Escort MK. I&II	9/68-4/87
5092510	Ford	Cortina MK III/Taurus	1970-82
5092512	Ford	Consul/Granada	3/72-8/85
5092514	Ford	Escort III&IV/Orion I&II	9/80-9/90
5092515	Ford	Escort V-VII/Orion III/P 100	10/87-
5092516	Ford	Fiesta	1/92-12/95
5092517	Ford	Fiesta/P 100/Scorpio I/Sierra	8/82-
5092518	Ford	Cougar/Mondeo I/II&III	2/93-
5092519	Ford	Escort V-VII/Fiesta/Ka/ Orion III/Puma	10/90-
	Mazda	121 JA/JB	3/96-
5092520	Ford	Transit	10/85-3/00
5092521	Ford	Transit	10/85-3/00
5092522	Ford	Fiesta/Ka	1/96-
	Mazda	121 JA/JB	3/96-
5092523	Ford	Focus	10/98-
5092524	Ford	Transit (F#_Y, F#_Y)	3/00-
	Hyundai	Elantra (Lantra) J2	11/95-
5093001	Mitsubishi	Carisma DA	7/95-
	Volvo	S40/V40	7/95-
5093002	Mitsubishi	Colt/Galant/Space Runner/ Space Star/Space Wagon	1/84-
5093201	Mazda	626 II GC	11/82-1987
5093202	Daewoo	Matiz	9/98-
	Mazda	323/626	11/82-9/97
5093203	Mazda	626 IV GE	8/91-4/97
5093301	MB	W 168 A-Klasse	7/97-
5093302	MB	Sprinter	2/95-
5093303	MB	Vito (638)/V-klasse (638/2)	2/96-
5093401	Hyundai	Accent/Coupe/S-Coupe	2/90-
5093402	Hyundai	Atos MX	2/98-
5093601	Opel	Kadett B	11/68-7/73
5093602	Opel	Ascona B/Kadett C & Kadett City/Manta B	8/73-8/81
5093602	Vauxhall	Cavalier/Chevette	1975-82
5093603	Opel	Ascona A/Manta A	10/70-8/75
5093605	Opel	Ascona C/Astra F/ Kadett D&E/Vectra A	9/79-3/01
5093605	Vauxhall	Astra MK III/Astravan MK III/	9/81-3/01

NK Nr./No.			
		Cavalier MK II&III	
5093608	Opel	Combo (Corsa)/Corsa B/Tigra	3/93-10/01
	Vauxhall	Combo (Corsa)/Corsa/Tigra	3/93-10/01
5093609	Opel	Astra F/Calibra/Vectra A	9/88-3/01
	Vauxhall	Astra MK III/Astravan MK III/ Cavalier MK III	9/88-3/01
5093610	Opel	Vectra A	9/88-9/95
	Vauxhall	Cavalier MK III	9/88-11/95
5093611	Daewoo	Leganza/Nubria	5/97-
	Opel	Vectra B	10/95-
	Toyota	Avensis (T22_)	9/97-
	Vauxhall	Vectra	10/95-
5093612	Hyundai	Sonata III&IV	3/98-
	Opel	Vectra B	10/95-
	Vauxhall	Vectra	10/95-
5093613	Opel	Astra G/Zafira	2/98-
	Vauxhall	Astra MK IV/ Astravan MK IV/Zafira	2/98-
5093703	Citroen	C15	10/84-12/97
	Peugeot	104/205/305/306/309/ 504/505/604	4/78-9/98
	Talbot	Samba	1982-6/86
5093706	Peugeot	106 I & II (- XSi)	9/91-
5093707	Peugeot	106 I & II	9/91-
5093708	Citroen	Berlingo/Xsara	10/96-
	Peugeot	205/305/306/309/Partner	2/83-
5093709	Peugeot	405	5/87-10/96
5093710	Peugeot	405	5/87-10/96
5093711	Citroen	Xantia	3/93-
	Peugeot	406/605	10/89-
5093712	Citroen	Evasion/Jumpy	6/94-
5093712	Fiat	Scudo	2/96-
	Peugeot	806/Expert	6/94-
5093713	Peugeot	206	9/98-
5093903	Renault	R/4/R5/R6/R14/R16	5/76-12/93
5093905	Renault	Clio I/R5/R9/R11/R19/Twingo	9/81-
5093906	Renault	Trafic	9/80-3/01
5093907	Renault	Clio II/Kangoo/Scenic	2/98-
5093908	Renault	Laguna	11/93-3/01
5093909	Renault	Clio II/Megane	1/96-
5093910	Renault	Megane	1/96-
5093911	Renault	Espace I&II/Trafic	9/80-3/01
5093912	Renault	Espace III/Master II	11/96-
5093913	Renault	Trafic	3/01-
5094104	Saab	90/99/900 I	10/74-6/94
5094105	Saab	900 I&II	11/78-2/98
5094106	Saab	9000	9/84-12/98
5094107	Saab	9.5	9/97-
5094301	Skoda	Fabia	12/99-
	Volkswagen	Lupo	4/97-



Anvendelsesliste
Buyer's guide
Nummerische Liste

NK Nr./No.			
5094302	Skoda	Felicia	10/94-
5094502	Toyota	Carina/Corolla	5/83-6/93
5094503	Toyota	Carina EAT19#/ST19#/CT19#	2/92-9/97
5094504	Toyota	Corolla	5/92-1/02
5094701	Volkswagen	Derby/Polo	4/75-8/94
5094703	Volkswagen	Caddy I/Golf I/Jetta I/Scirocco	2/74-8/93
5094704	Seat	Cordoba/Ibiza/Toledo	3/91-10/02
	Volkswagen	Golf II&III/Jetta II/Passat/ Scirocco/Vento	3/81-4/99
5094706	Volkswagen	Transporter Type III	5/79-7/92
5094707	Audi	A2	2/00-
	Seat	Arosa	5/97-
	Volkswagen	Caddy II/Lupo/Polo	10/94-
5094708	Audi	A2	2/00-
	Seat	Arosa	5/97-
	Volkswagen	Caddy II/Lupo/Polo	10/94-
5094709	Audi	A3 (8L1)	6/96-
	Seat	Leon	11/99-
	Skoda	Octavia (1U2 & 1U5)	9/96-
	Volkswagen	Bora/Golf IV/New Beetle	8/97-
5094710	Audi	A4	1/95-9/01
	Mazda	626 V GF	5/97-
5094711	Audi	A4	1/95-9/01
5094712	Audi	100/A6/V8	8/84-12/97
5094715	Seat	Cordoba/Ibiza	3/93-10/02
	Volkswagen	Golf III/Passat/Vento	2/88-4/99
5094801	Volvo	240/260 Serie	8/74-7/93
5094802	Volvo	240/260 Serie	8/74-7/93
5094803	Volvo	240/260 Serie	8/74-7/93
5094804	Volvo	240/260 Serie	8/74-7/93
	Volvo	740/760/780 Serie	8/82-7/92
5094805	Volvo	340/343/345/360	2/76-7/91
5094806	Volvo	440/460/480	4/86-12/96
5094807	Volvo	S60/C70/S70/V70/S80	1/97-
5094808	Volvo	S60/C70/S70/V70/S80	1/97-
5095001	Daewoo	Espero/Lanos	2/95-
	Saab	9.3	2/98-
5101001	Alfa Romeo	145/146/155/GTV/Spider	2/92-
	Fiat	Brava/Bravo/Coupe/Marea/ Tempra/Tipo	11/87-
5101002	Alfa Romeo	145/146/155/GTV/Spider	2/92-
	Fiat	Brava/Bravo/Coupe/Marea/ Tempra/Tipo	11/87-
5101003	Alfa Romeo	145/146/155/GTV/Spider	2/92-
5101003	Fiat	Brava/Bravo/Coupe/Marea/ Tempra/Tipo	11/87-
5101004	Alfa Romeo	147/156	11/97-
5101005	Alfa Romeo	147/156	11/97-
5101006	Alfa Romeo	147/156	11/97-
5101007	Alfa Romeo	147/156	11/97-
5101008	Alfa Romeo	147/156	11/97-



NK Nr./No.			
5101009	Alfa Romeo	147/156	11/97-
5101010	Alfa Romeo	Alfa 166	9/98-
5101011	Alfa Romeo	Alfa 166	9/98-
5101012	Alfa Romeo	Alfa 166	9/98-
5101013	Alfa Romeo	Alfa 166	9/98-
5101201	Rover Group	Mini 850/1000, Clubman & Cooper	1959-
5101501	BMW	3-Series (E30)&(E36)/Z3	9/82-
5101502	BMW	3-Series (E30)	9/82-6/94
5101503	BMW	3-Series (E30)	9/82-6/94
5101504	BMW	5-Series (E28)/6-Series (E24)	6/81-9/90
5101505	BMW	3-Series (E30)	9/82-6/94
5101506	BMW	5-Series (E28)&(E34)/ 6-Series (E24)/7-Series (E32)	6/81-1/97
5101507	BMW	5-Series (E28)/ 6-Series (E24)/7-Series (E23)	6/81-9/90
5101508	BMW	5-Series (E34)/7-Series (E32)	9/86-1/97
5101509	BMW	5-Series (E34)	1/88-1/97
5101510	BMW	5-Series (E34)	1/88-1/97
5101511	BMW	5-Series (E34)	1/88-1/97
5101512	BMW	5-Series (E39)	4/96-
5101513	BMW	3-Series (E46)	3/98-
5101516	BMW	5-Series (E39)/7-Series (E38)	10/94-
5101517	BMW	5-Series (E39)	11/95-
5101518	BMW	5-Series (E39)	11/95-
5101519	BMW	730i, 740i, 750i E38	10/94-11/01
5101520	BMW	730i, 740i, 750i E38	10/94-11/01
5101901	Citroen	BX & BX Break	9/82-12/94
5101902	Citroen	2 CV/Acadiane/Ami 6/8/ C 25/Dyane 4/6/Mehari	1959-
5101903	Citroen	BX/Xantia/XM	9/82-
5101904	Citroen	CX	10/75-6/80
5101905	Citroen	Berlingo/Xsara/ZX	3/91-
	Peugeot	306/Partner	3/93-
5101906	Citroen	Berlingo/Xsara/ZX	3/91-
	Peugeot	306/Partner	3/93-
5101907	Citroen	Evasion/Jumpy	6/94-
	Fiat	Scudo/Ulysse	6/94-
	Peugeot	806/Expert	6/94-
5101908	Citroen	Evasion/Jumpy	6/94-
	Fiat	Scudo/Ulysse	6/94-
	Peugeot	806/Expert	6/94-
5101909	Citroen	Evasion/Jumpy	6/94-
	Fiat	Scudo/Ulysse	6/94-
	Peugeot	806/Expert	6/94-
5101910	Citroen	AX/Saxo	6/86-
	Peugeot	106 I & II (- XSi)	9/91-
5101911	Citroen	AX/Saxo	6/86-
	Peugeot	106 I & II (- XSi)	9/91-
5101912	Citroen	Saxo	3/96-
	Peugeot	106 I & II Xsi	9/91-



Anvendelsesliste
Buyer's guide
Nummerische Liste

NK Nr./No.			
5101913	Citroen	Saxo	3/96-
	Peugeot	106 I & II Xsi	9/91-
5101914	Citroen	AX	6/86-12/98
5101920	Citroen	Xantia (X1/X2)	3/93-
5101921	Citroen	Xantia (X1/X2)	3/93-
5101922	Citroen	Xantia (X1/X2)	3/93-
5101923	Citroen	Berlingo/Xsara Picasso	10/96-
5101924	Citroen	Berlingo/Xsara Picasso	10/96-
5102201	Nissan	Almera I N15	9/95-7/00
5102202	Nissan	Almera I N15	9/95-7/00
5102203	Nissan	Micra K11	8/92-2/03
5102204	Nissan	Micra K11	8/92-2/03
5102205	Nissan	Primera/Primera Wagon W11	6/90-
5102206	Nissan	Primera	6/90-
5102207	Nissan	Primera	9/96-
5102208	Nissan	Primera	9/96-
5102209	Nissan	Primera P10	6/90-8/96
5102210	Nissan	Primera P10	6/90-8/96
5102301	Fiat	Barchetta/Cinquecento/ Punto/Seicento/Uno	1/83-
5102302	Fiat	Cinquecento/Seicento/Uno	1/83-
5102303	Fiat	Doblo/Palio/Siena/Strada	4/96-
5102304	Fiat	Palio/Siena	4/96-
5102305	Fiat	Palio/Siena	4/96-
5102306	Fiat	Palio/Siena	4/96-
5102307	Fiat	Palio/Siena	4/96-
5102308	Fiat	Barchetta/Punto	9/93-
5102309	Fiat	Barchetta/Punto	9/93-
5102310	Citroen	Jumper 230	2/94-4/02
	Fiat	Ducato	3/94-4/02
	Peugeot	Boxer (230)	3/94-4/02
5102311	Citroen	Jumper 230	2/94-4/02
	Fiat	Ducato	3/94-4/02
	Peugeot	Boxer (230)	3/94-4/02
5102314	Seat	Arosa	5/97-
	Volkswagen	Lupo/Polo	10/94-
5102315	Seat	Arosa	5/97-
	Volkswagen	Lupo/Polo	10/94-
5102316	Fiat	Punto (176)	9/93-2/00
5102317	Fiat	Tempra/Tipo	11/87-8/96
5102318	Fiat	Brava/Bravo/Coupe/Marea/ Palio/Siena	3/94-
5102319	Fiat	Doblo/Strada	6/99-
5102320	Fiat	Doblo/Strada	6/99-
5102321	Fiat	Punto (188)	9/99-
5102322	Fiat	Punto (188)	9/99-
5102323	Fiat	Stilo	10/01-
5102324	Fiat	Stilo	10/01-
5102325	Fiat	Multipla	4/99-
5102326	Fiat	Multipla	4/99-
5102327	Fiat	Multipla	4/99-



NK Nr./No.			
5102328	Fiat	Multipla	4/99-
5102501	Ford	Cortina MK III/Taurus	1970-82
5102502	Ford	Cortina MK III/Taurus	1970-82
5102503	Ford	Cortina MK III/Taurus	1970-82
5102504	Ford	Cortina MK III/Taurus	1970-82
5102505	Ford	P 100/Scorpio I&II/Sierra	8/82-
5102506	Ford	Escort III&IV/Orion I&II	9/80-9/90
5102507	Ford	P 100/Scorpio I/Sierra	8/82-
5102508	Ford	Mondeo I	2/93-8/96
5102509	Ford	Mondeo I&II	2/93-
5102510	Ford	Escort V-VII/Fiesta/Ka/Orion III	5/89-
5102511	Ford	Escort V-VII/Fiesta/Ka/Orion III	5/89-
5102512	Ford	Fiesta/Puma	1/96-
	Mazda	121 JA/JB	3/96-
5102513	Ford	Fiesta/Puma	1/96-
	Mazda	121 JA/JB	3/96-
5102514	Ford	Galaxy	11/95-
	Seat	Alhambra	4/96-
	Volkswagen	Sharan (7M)	5/95-
5102515	Ford	Galaxy	11/95-
	Seat	Alhambra	4/96-
	Volkswagen	Sharan (7M)	5/95-
5102517	Ford	Scorpio I&II	4/85-8/98
5102518	Ford	Focus	10/98-
5102519	Ford	Focus	10/98-
5102520	Ford	Mondeo I&II	2/93-
5102523	Ford	Fiesta	11/01-
5102524	Ford	Fiesta	11/01-
5102525	Ford	Mondeo III	11/00-
5102526	Ford	Mondeo III	11/00-
5103302	MB	W 168 A-Klasse	7/97-
5103303	MB	W124/W201/W203/ W208/W210	10/82-
5103304	MB	W140	2/91-2/99
5103306	MB	W202/W208/W210	3/93-
5103307	MB	W202	3/93-3/01
5103308	MB	W202	3/93-3/01
5103309	MB	W 168 A-Klasse	7/97-
5103310	MB	W 168 A-Klasse	7/97-
5103312	MB	W124	11/84-3/98
5103313	MB	W201 190 D/E	10/82-8/93
5103315	MB	W202/W208	3/93-
5103316	MB	W202/W208	3/93-
5103401	Hyundai	Accent X3	10/94-01/00
5103402	Hyundai	Accent X3	10/94-01/00
5103403	Hyundai	Accent X3	10/94-01/00
5103601	Opel	Astra F/Calibra/Vectra A	9/88-3/01
	Vauxhall	Astra MK III/ Astravan MK III/Cavalier MK III	9/88-3/01
5103602	Opel	Astra F/Calibra/Vectra A	9/88-3/01



Anvendelsesliste
Buyer's guide
Nummerische Liste

NK Nr./No.		
	Vauxhall	Astra MK III/ 9/88-3/01
		Astravan MK III/Cavalier MK III
5103603	Opel	Astra F/Calibra/Vectra A 9/88-
	Vauxhall	Astra MK III/ 9/88-3/01
		Astravan MK III/Cavalier MK III
5103604	Opel	Ascona C/Astra F 9/81-
	Vauxhall	Astra MK III/ 9/81-3/01
		Astravan MK III/Cavalier MK II
5103605	Opel	Combo (Corsa)/Corsa B/Tigra 3/93-10/01
	Vauxhall	Combo (Corsa)/Corsa/Tigra 3/93-
5103606	Opel	Omega A/Senator B 8/86-5/94
	Vauxhall	Carlton MK III/Senator MK II 8/86-3/94
5103607	Opel	Omega A/Senator B 8/86-5/94
	Vauxhall	Carlton MK III/Senator MK II 8/86-3/94
5103608	Daewoo	Espero/Lanos/Nexia 2/95-
	Opel	Kadett E 9/84-2/93
5103609	Daewoo	Espero/Lanos/Nexia 2/95-
	Opel	Kadett E 9/84-2/93
5103610	Opel	Vectra B 10/95-
	Vauxhall	Vectra 10/95-
5103611	Opel	Astra G/Vectra B/Zafira 10/95-
	Vauxhall	Astra MK IV/Astravan MK IV/ 10/95-
		Vectra/Zafira
5103612	Opel	Astra G/Vectra B/Zafira 10/95-
	Vauxhall	Astra MK IV/Astravan MK IV/ 10/95-
		Vectra/Zafira
5103614	Opel	Agila H00 9/00-
	Vauxhall	Agila H00 9/00-
5103615	Opel	Omega B 3/94-7/03
	Vauxhall	Omega B 3/94-
5103616	Opel	Omega B 3/94-7/03
	Vauxhall	Omega B 3/94-
5103619	Opel	Vectra B 10/95-
	Vauxhall	Vectra 10/95-
5103621	Opel	Signum/Vectra C 4/02-
	Vauxhall	Vectra Mk II 4/02-
5103702	Citroen	C15 10/84-12/97
	Peugeot	205/309 2/83-9/98
5103703	Citroen	C15 10/84-12/97
	Peugeot	205 2/83-9/98
5103704	Peugeot	309 10/85-12/93
5103705	Peugeot	405 5/87-10/96
5103706	Peugeot	405 5/87-10/96
5103707	Peugeot	406 10/95-
5103708	Peugeot	406 10/95-
5103710	Peugeot	605/607 10/89-
5103711	Peugeot	206 9/98-
5103712	Peugeot	206/307 9/98-
5103713	Peugeot	307 10/01-
5103714	Peugeot	309 10/85-12/93
5103901	Renault	Clio I&II/Kangoo 1/91-
5103902	Renault	Clio I&II/Kangoo 1/91-



NK Nr./No.		
5103903	Renault	Espace III/Laguna 11/93-
5103904	Renault	Laguna 11/93-
5103905	Renault	Megane 1/96-
5103907	Renault	R19 11/88-1996
5104001	Rover	75 (RJ) 2/99-
5104002	Rover	75 (RJ) 2/99-
5104303	Skoda	Felicia 10/94-
5104304	Skoda	Felicia 10/94-
5104501	Toyota	Div. Toyota
5104701	Audi	80/90 4/80-8/91
	Volkswagen	Passat/Santana 8/80-88
5104702	Audi	80/90/Cabriolet 4/80-
	Volkswagen	Passat/Santana 8/80-88
5104705	Seat	Cordoba/Ibiza/Inca/Toledo 3/91-
	Volkswagen	Caddy II/Corrado/Golf II&III/ 1/84-9/01
		Jetta II/Passat/Polo/Vento
5104707	Volkswagen	Golf II/Jetta II 8/83-12/92
5104708	Audi	A3 (8L1) 6/96-
	Seat	Ibiza/Leon/Toledo II 4/99-
	Skoda	Octavia (1U2 & 1U5) 9/96-
	Volkswagen	Bora/Golf IV/New Beetle 6/97-
5104710	Volkswagen	Transporter Type III 5/79-7/92
5104711	Volkswagen	Transporter Type III 5/79-7/92
5104712	Volkswagen	LT 28/31/35/40/45/50 4/75-5/96
5104713	Volkswagen	LT 28/31/35/40/45/50 4/75-5/96
5104714	Audi	A4/A6/A8 3/94-
	Volkswagen	Passat 8/96-
5104715	Audi	A4/A6/A8 3/94-
	Volkswagen	Passat 8/96-
5104716	Audi	A4/A6/A8 3/94-
	Volkswagen	Passat 8/96-
5104717	Audi	A4/A6/A8 3/94-
	Volkswagen	Passat 8/96-
5104718	Audi	100/A6 12/90-12/97
5104719	Audi	100/A6 12/90-12/97
5104720	Audi	A3 (8L1) 6/96-
	Seat	Cordoba/Ibiza/Inca/ 3/91-
		Leon/Toledo
	Skoda	Octavia (1U2 & 1U5) 9/96-
	Volkswagen	Bora/Caddy/Golf II/III&IV/ 8/83-
		Jetta II/New Beetle/
		Passat/Vento
5104721	Audi	50 1975-78
5104721	Volkswagen	Polo 4/75-8/94
5104722	Audi	50 1975-78
	Volkswagen	Derby/Polo 4/75-8/94
5104723	Volkswagen	Transporter T3 5/79-7/92
5104724	Seat	Toledo 3/91-3/99
	Volkswagen	Corrado/Golf II/Jetta II 8/83-12/95
5104725	Volkswagen	Passat 2/88-5/97
5104726	Volkswagen	Golf III/Vento 11/91-4/99



Anvendelsesliste
Buyer's guide
Nummerische Liste

NK Nr./No.		
5104727	Volkswagen Golf III	11/91-4/99
5104730	Volkswagen Transporter T4	7/90-12/95
5104731	Volkswagen Transporter T4	1/96-
5104732	Volkswagen Transporter T4	7/90-
5104739	Audi A3 (8P1),(8PA)	5/03-
	Seat Altea (5P1)	3/04-
	Skoda Octavia (1Z3),(1Z5)	6/04-
	Volkswagen Caddy III/Golf V/ Golf V Plus/Touran	2/03-
5104806	Volvo 240/260 Serie	8/74-7/93
5104807	Volvo 240/260 Serie	8/74-7/93
5104808	Volvo 240/260 Serie	8/74-7/93
5104810	Volvo 240/260 Serie	1974-8/93
5104811	Volvo 240/260 Serie	1974-8/93
5104812	Volvo 240/260 Serie	1974-8/93
5104813	Volvo 240/260 Serie	1974-8/93
5104814	Volvo 142/144/145/164/240/260/ 740/760/780/940/960	8/68-10/98
5104815	Volvo 142/144/145/164/240/260/ 740/760/780/940/960	8/68-10/98
5104820	Volvo S40/V40	7/95-
5104821	Volvo S40/V40	7/95-
5104822	Volvo S40/V40	7/95-
5105001	Daewoo Nubira (KLAJ)	5/97-
5105002	Daewoo Nubira (KLAJ)	5/97-
5111002	Alfa Romeo 147/156	11/97-
5111003	Alfa Romeo 147/156	11/97-
5111004	Alfa Romeo Alfa 166	9/98-
5111005	Alfa Romeo Alfa 166	9/98-
5111006	Alfa Romeo Alfa 166	9/98-
5111007	Alfa Romeo GTV/Spider	6/95-
5111008	Alfa Romeo GTV/Spider	6/95-
5111501	BMW 1500/1502/1600/1600-2/ 1602/1800/1802/2000/ 2002/3-Series (E21)/ 5-Series (E12)	10/94-11/01
5111502	BMW 730i, 740i, 750i E38	9/82-
5111503	BMW 3-Series (E30)&(E36)/Z1/Z3	6/81-1/97
5111505	BMW 5-Series (E28)&(E34)/ 6-Series (E24)/7-Series (E32)	11/95-
5111506	BMW 5-Series (E39)	11/95-
5111507	BMW 5-Series (E39)	11/95-
5111508	BMW 5-Series (E39)	11/95-
5111509	BMW 3-Series (E36)/5-Series (E28)/ 6-Series (E24)	6/81-8/00
5111510	BMW 3-Series (E46)	3/98-
	Seat Cordoba/Ibiza	2/02-
	Skoda Fabia	12/99-
	Volkswagen Polo (9N_)	10/01-
5111511	BMW 3-Series (E46)	3/98-



NK Nr./No.		
5111512	BMW 5-Series (E34)/Z3	1/88-
5111513	BMW 5-Series (E39)/7-Series (E38)	10/94-
5111514	BMW 5-Series (E39)	4/96-
5111515	BMW 730i, 740i, 750i E38	10/94-11/01
5111522	BMW X5 (E53)	2/02-
5111523	BMW X5 (E53)	2/02-
5111524	BMW X5 (E53)	2/02-
5111901	Citroen Berlingo/Xsara/ZX Peugeot 306/Partner	3/91- 3/93-
5111902	Citroen Saxo/Xantia Peugeot 106 I & II/406	3/93- 9/91-
5111903	Citroen C5 Peugeot 406/607	3/01- 10/95-
5111909	Citroen BX & BX Break	9/82-12/94
5111910	Citroen Xantia (X1/X2)	3/93-
5112201	Nissan Cherry/Micra/Stanza/Sunny	10/78-7/92
5112202	Nissan Bluebird 910	10/79-5/84
5112203	Nissan King Cab 720 - Pick-Up	4/83-7/85
5112204	Nissan King Cab D21 - Pick-Up D21	8/85-2/98
5112205	Mitsubishi L 200 Nissan King Cab/Terrano II	8/80-8/96 8/85-
5112206	Nissan King Cab 720	9/79-7/85
5112207	Nissan King van E24/Urvan E24 Renault Trafic	9/86- 9/80-3/01
5112208	Nissan 100 NX/Almera/Bluebird/ Maxima/Prairie/Primera/Sunny	4/84- 10/90-
5112209	Nissan Almera I/Primera/Sunny	7/00-
5112210	Nissan Almera II N16	8/92-2/03
5112211	Nissan Micra K11	8/92-2/03
5112212	Nissan Micra K11	6/90-
5112213	Nissan Patrol/Primera	6/90-3/98
5112214	Nissan Primera	11/92-
5112215	Nissan Serena/Vanette	11/92-
5112216	Nissan Serena/Vanette	2/92-
5112301	Alfa Romeo 145/146/155/GTV/Spider Fiat Brava/Bravo/Cinquecento/ Coupe/Tempra/Tipo	11/87- 4/89-8/99
5112302	Lancia Dedra/Delta Citroen Evasion/Jumpy Fiat Scudo/Ulysse	6/94- 6/94- 5/95-9/02
5112303	Lancia Zeta Peugeot 806/Expert	6/94- 11/95-
5112304	Ford Galaxy Seat Alhambra Volkswagen Sharan (7M)	4/96- 5/95- 3/91-
5112304	Seat Arosa/Toledo Skoda Felicia	10/94- 8/83-
5112305	Volkswagen Golf II/Lupo/Polo Seat Cordoba/Ibiza/Toledo Volkswagen Caddy II/Golf II&III/Jetta II/Vento	3/91-10/02 8/83-
5112306	Fiat Doblo/Marea/Multipla	9/96-
5112307	Lancia Dedra	4/89-7/99



Anvendelsesliste
Buyer's guide
Nummerische Liste

NK Nr./No.			
5112310	Fiat	Stilo	10/01-
5112311	Fiat	Doblo	3/01-
5112312	Seat	Arosa	3/91-
	Skoda	Felicia	10/94-
	Volkswagen	Lupo/Polo	10/94-
5112501	Ford	Cortina MK III/Taurus	1970-82
5112502	Ford	Consul/Granada	3/72-8/85
5112503	BMW	3-Series (E30)&(E36)/ 5-Series (E28)&(E34)/ 6-Series (E24)/7-Series (E32)/ 8-Series (E31)	6/81-12/99
	Ford	Cougar/Escort/Fiesta/Focus/ Ka/Mondeo/Orion/Puma	10/90-
	Mazda	121 JA/JB	3/96-
5112507	Ford	Transit	10/85-9/92
5112508	Ford	Transit	10/85-3/00
5112509	Ford	Focus	10/98-
5112510	Ford	Mondeo I	2/93-8/96
5112511	Ford	Mondeo I&II	2/93-
5112512	Ford	Mondeo II	9/96-
5112513	Ford	Mondeo III	11/00-
5112514	Ford	Mondeo III	11/00-
5112515	Ford	Scorpio II	10/94-8/98
5112516	Ford	Scorpio II	10/94-8/98
5112517	Ford	Transit Connect	9/02-
5112518	Ford	Transit Connect	9/02-
5112519	Ford	Transit (F#_Y, F#_Y)	3/00-
5112520	Ford	Fiesta/Fusion	11/01-
5112521	Ford	Mondeo III	11/00-
5112601	Honda	Civic	10/83-
5112602	Honda	Civic/CR-V	10/95-
5112603	Honda	Accord VII CG/CH	10/98-
5112604	Honda	Accord VII CG/CH	10/98-
5112605	Honda	Civic EJ6/EJ8/EJ9/EK3/EK4	11/95-2/01
5112606	Honda	Civic EJ6/EJ8/EJ9/EK3/EK4	11/95-2/01
5112607	Honda	Civic/Integra	9/94-10/01
5112608	Honda	Concerto HW	8/89-3/95
	Rover Group	Rover 25/214/216/218/220/ 414/416/418/ 420	10/89-
5112611	Honda	CR-V I (RD)	1/99-
5112612	Honda	CR-V I (RD)	1/99-
5113002	Mitsubishi	Colt/Lancer	12/78-6/92
5113003	Mitsubishi	Pajero I LO41G, LO43G, LO44G, LO46G, LO48G, LO49G	4/82-12/91
5113004	Mitsubishi	Pajero I LO41G, LO43G, LO44G, LO46G, LO48G, LO49G	4/82-12/91
5113005	Mitsubishi	Pajero I LO41G, LO43G, LO44G, LO46G, LO48G, LO49G	4/82-12/91
5113006	Mitsubishi	Colt V CJ Serie	5/96-
5113007	Mitsubishi	Eclipse/Galant	4/91-
5113008	Mitsubishi	Space Star DG0	6/98-
5113009	Mitsubishi	Space Wagon	1/84-10/98
5113010	Mitsubishi	Space Wagon	1/84-10/98
5113011	Mitsubishi	Space Wagon	1/84-10/98



NK Nr./No.			
5113201	Mazda	323	11/76-3/93
5113202	Mazda	323	5/85-10/94
5113203	Mazda	626 II GC	11/82-1987
5113204	Daihatsu	Charmant A35/A55/A60	10/81-7/87
	Hyundai	Accent X3	10/94-01/00
	Mazda	626 II GC	11/82-1987
	Mitsubishi	Galant III E11A, E12A, E13A, E15A, E16A	6/84-12/87
5113205	Mazda	626 III	5/87-9/97
5113206	Mazda	626 III	5/87-9/97
5113207	Mazda	323 IV BG	9/89-10/94
5113208	Kia	Clarus	7/96-
	Mazda	323/626/MX-6/Xedos 6	8/91-
5113209	Kia	Clarus	7/96-
	Mazda	323/626/MX-6/Xedos 6	8/91-
5113210	Mazda	323 V BA	8/94-9/98
5113211	Mazda	626 IV/MX-6/Xedos 6	8/91-
5113212	Mazda	323 VII/Premacy	9/98-
5113213	Mazda	323 VII/Premacy	9/98-
5113214	Mazda	626 V GF	5/97-
5113215	Mazda	MPV I LV	5/96-9/99
5113216	Mazda	MPV I LV	5/96-9/99
5113225	Mazda	MX-5 II NB	5/98-
5113226	Mazda	MX-5 II NB	5/98-
5113301	MB	W 168 A-Klasse	7/97-
5113302	MB	W202/W203/W208/W210	3/93-
5113303	MB	W202/W203/W208/W210	3/93-
5113304	MB	W124/W201/W202/ W208/W210	10/82-
5113305	MB	W114/W115/C123/T123/W123	1968-10/84
5113307	MB	Sprinter	2/95-
	Volkswagen	LT 28-35 II, LT 28-46 II	5/96-
5113308	MB	Sprinter	2/95-
	Volkswagen	LT 28-35 II, LT 28-46 II	5/96-
5113309	MB	Sprinter	2/95-
	Volkswagen	LT 28-35 II, LT 28-46 II	5/96-
5113310	MB	W140	2/91-2/99
5113311	MB	W140	2/91-2/99
5113312	MB	W140	2/91-2/99
5113313	MB	Vito/V-klasse	2/96-
5113314	MB	Vito/V-klasse	2/96-
5113315	MB	Vito/V-klasse	2/96-
5113316	MCC	Smart	7/98-
5113317	MCC	Smart	7/98-
5113318	MB	W210	6/95-3/03
5113319	MB	W210	6/95-3/03
5113320	MB	W124/W201/W202/ W203/W208/W210	11/84-
5113321	MB	W202/W208/W210	3/93-
5113335	MB	W220	1/00-
5113336	MB	W203	1/00-
5113337	MB	W203	1/00-
5113338	MB	W203	1/00-
5113339	MB	W203	1/00-



Anvendelsesliste
Buyer's guide
Nummerische Liste

NK Nr./No.		
5113401	Hyundai Accent LC	01/00-
5113402	Hyundai Accent LC	01/00-
5113403	Hyundai Accent LC	01/00-
5113404	Hyundai Atos MX	2/98-
5113405	Hyundai Coupe RD	8/96-4/02
	Hyundai Elantra (Lantra) J2	11/95-
5113406	Hyundai H-1/Starex	6/97-
5113407	Hyundai H-1/Starex	6/97-
5113408	Hyundai Sonata II Y3	5/93-6/98
5113409	Hyundai Sonata II Y3	5/93-6/98
5113410	Hyundai Sonata III&IV	3/98-
5113411	Hyundai Sonata III EF	3/98-10/01
5113412	Hyundai Sonata III&IV	3/98-
5113501	Kia Pregio TB	10/97-
5113502	Kia Shuma FB	3/96-
5113503	Kia Shuma FB	3/96-
5113601	Opel Ascona C	9/81-10/88
	Vauxhall Cavalier MK II	9/81-10/88
5113602	Opel Ascona B/Kadett C & Kadett City/Manta B	8/73-8/81
5113603	Daewoo Espero/Lanos/Nexia	2/95-
	Opel Kadett D&E	9/79-2/93
5113604	Opel Commodore B&C/Monza/ Rekord D&E/Senator A	1/72-8/86
	Vauxhall Senator	9/84-8/87
5113605	Opel Astra F/Calibra/Vectra A	9/88-3/01
	Saab 900 II	7/93-2/98
	Vauxhall Astra MK III/Astravan MK III/ Cavalier MK III	9/88-3/01
5113606	Opel Astra F/Vectra A	9/88-3/01
	Vauxhall Astra MK III/Astravan MK III/ Cavalier MK III	9/88-3/01
5113607	Opel Commodore C/Monza/ Rekord E/Senator A	2/78/8/86
	Vauxhall Senator	9/84-8/87
5113608	Opel Astra F/Calibra/Vectra A	9/88-
	Saab 9.3	2/98-
	Vauxhall Astra MK III/Astravan MK III/ Cavalier MK III	9/88-3/01
5113609	Opel Combo/Corsa C/ Meriva/Vectra B	10/95-
	Saab 9.5	9/97-
	Vauxhall Combo/Corsa MK II/ Meriva/Vectra	10/95
5113610	Opel Omega B	3/94-7/03
	Vauxhall Omega B	3/94-
5113611	Opel Astra G/Zafira	2/98-
	Vauxhall Astra MK IV/ Astravan MK IV/Zafira	2/98-
5113613	Opel Frontera A&B	3/92-
	Suzuki Baleno/Liana	7/95-
	Vauxhall Frontera	3/92-
5113614	Opel Frontera	3/92-



NK Nr./No.		
	Suzuki Baleno/Liana	7/95-
	Vauxhall Frontera	3/92-
5113615	Opel Movano	7/98-
	Renault Master II	7/98-
	Vauxhall Movano	7/98-
5113616	Opel Movano	7/98-
	Renault Master II	7/98-
	Vauxhall Movano	7/98-
5113617	Opel Signum/Vectra C	4/02-
	Vauxhall Signum/Vectra MK II	5/03-
5113621	Nissan Primastar	3/01-
	Opel Vivaro	8/01-
	Renault Espace IV/Laguna/Trafic/ Vel Satis	3/01
	Vauxhall Vivaro	8/01-
5113622	Opel Omega A/Senator B	8/86-5/94
	Vauxhall Carlton MK III/Senator MK II	8/86-3/94
5113701	Citroen AX	6/86-12/98
	Peugeot 106 I & II	9/91-
5113703	Peugeot 405	5/87-10/96
5113704	Citroen Visa	1980-3/91
	Peugeot 205/309	2/83-9/98
5113705	Peugeot 406	10/95-
5113706	Citroen C3	2/02-
	Peugeot 206	9/98-
5113707	Peugeot 605/607/Boxer	3/94-
5113708	Peugeot 605/607	1989-
5113709	Citroen Jumper 230	2/94-4/02
	Fiat Ducato/Talento	5/81-4/02
5113710	Peugeot 307	10/01-
5113711	Peugeot 406	10/95-
5113712	Citroen XM	3/89-10/00
	Peugeot 605	10/89-
5113901	Renault R4/R5/R6/R12/R15/R17/R18	1968-12/93
5113902	Renault Clio/Kangoo/Megane/Scenic	1/91-
5113903	Renault Master I	8/80-7/98
5113905	Renault Twingo	3/93-
5113906	Renault Twingo	3/93-
5113909	Renault Espace/Laguna/Safrane	7/84-
5114001	Rover Group Landrover Defender/ Landrover Discovery I	9/89-
5114004	Rover Group Landrover Freelander	10/97-
5114006	Rover Group Rover 75	2/99-
5114007	Rover Group Mini One & Cooper	6/01-
5114008	Rover Group Mini One & Cooper	6/01-
5114009	Rover Group Mini One & Cooper	6/01-
5114101	Saab 9000	9/84-12/98
5114501	Mitsubishi Colt IV CA Serie	4/92-4/96
	Toyota Corolla	3/79-5/88
5114502	Toyota Carina AT151/ST150/	10/83-5/88



Anvendelsesliste
Buyer's guide
Nummerische Liste

NK Nr./No.		
		ST151/CT150
5114503	Toyota	Camry/Corolla 3/82-5/91
5114504	Toyota	Hiace 2/77-11/89
5114505	Toyota	Hiace 12/82-11/89
5114506	Kia	Clarus 7/96-
	Toyota	Camry/Celica/Corolla 5/85-11/01
5114507	Hyundai	Coupe/Elantra (Lantra) 10/90-
	Mitsubishi	Colt/Galant/Lancer/Pajero Pinin 11/87-
5114507	Toyota	Celica/Corolla/Rav 4 5/92-1/02
5114508	Toyota	Camry/Carina II 12/87-11/01
5114509	Toyota	Camry/Carina II/Celica 8/85-11/01
5114510	Toyota	Avensis/Carina E/Picnic/ Sportsvan 2/92-
5114511	Toyota	Avensis/Carina E/Picnic/ Sportsvan 2/92-
5114512	Toyota	Carina/Celica/Corolla 8/85-11/99
5114514	Toyota	Avensis (T22_) 9/97-
5114515	Toyota	Avensis/Corolla/ Corolla Verso 1/02-
5114516	Toyota	Avensis (T25) 4/03-
5114517	Toyota	Avensis (T25) 4/03-
5114518	Toyota	Avensis Verso/Picnic/ SportsVan 5/96-
5114519	Toyota	Camry SXV10/VCV10/ SXV20/VCV20 6/91-11/01
5114520	Toyota	Camry SXV10/VCV10/ SXV20/VCV20 6/91-11/01
5114521	Toyota	Camry SXV10/VCV10/ SXV20/VCV20 6/91-11/01
5114522	Toyota	Camry SXV10/VCV10/ SXV20/VCV20 6/91-11/01
5114523	Toyota	Corolla AE11#/EE11#/CE11# 4/97-1/02
5114524	Toyota	Hiace LH10#/LH11#/ RZH10#/RZH11# 8/89-8/95
5114525	Toyota	Hiace_H12 8/95-
5114526	Toyota	Hiace_H12 8/95-
5114527	Toyota	Hiace_H12 8/95-
5114528	Toyota	Hiace_H12 8/95-
5114529	Toyota	Previa 5/90-8/00
5114530	Toyota	Previa 5/90-8/00
5114531	Toyota	Previa 8/00-
5114532	Toyota	Rav 4 XA2 6/00-
5114533	Toyota	Rav 4 XA2 6/00-
5114534	Toyota	Rav 4 XA2 6/00-
5114535	Toyota	Yaris_CP10 / Yaris Verso NC/LP 4/99-
5114701	Volkswagen	Transporter T4 7/90-
5114702	Audi	A3 (8L1) 6/96-
	Seat	Leon/Toledo 3/91-
5114702	Skoda	Octavia (1U2 & 1U5) 9/96-

NK Nr./No.		
	Volkswagen	Bora/Golf IV/New Beetle 8/97-
5114705	Audi	A4/A6/A8 3/94-
	Volkswagen	Passat 8/96-11/00
5114707	Volkswagen	Passat 2/88-8/96
5114708	Audi	80/A4 9/91-
5114709	Audi	80/A4 9/91-
5114710	Audi	A8 3/94-
5114717	Audi	A4/A6 6/94-
	Skoda	Superb 2/02-
	Volkswagen	Passat 8/96-
5114718	Audi	A4/A6 6/94-
	Skoda	Superb 2/02-
	Volkswagen	Passat 8/96-
5114719	Audi	A2 2/00-
5114720	Audi	A2 2/00-
5114721	Audi	A8 3/94-
5114722	Audi	A8 3/94-
5114723	Audi	A3 3/03-
5114723	Volkswagen	Caddy III/Golf V/Touran 2/03-
5114725	Volkswagen	Corrado/Golf III 9/88-4/99
5114727	Volkswagen	Passat 2/88-5/97
5114728	Volkswagen	Passat 2/88-5/97
5114730	Volkswagen	Touareg 10/02-
5114731	Volkswagen	Touareg 10/02-
5114733	Volkswagen	Touran 2/03-
5114734	Volkswagen	Transporter T4 7/90-
5114735	Volkswagen	Transporter T5 4/03-
5114736	Audi	100/A6 12/90-12/97
5114745	Audi	80/90/Cabriolet/Coupe 9/86-
5114801	Volvo	240/260 Serie 8/74-7/93
5114802	Volvo	340/343/345/360 2/76-7/91
5114803	Volvo	740/760/780/940/960 Serie 8/82-10/98
5114804	Mitsubishi	Carisma DA 7/95-
	Volvo	S40/V40 7/95-
5114805	Mitsubishi	Carisma/Space Star 7/95-
	Volvo	S40/V40 7/95-
5114806	Volvo	850/C70/S70/V70 6/91-
5114807	Volvo	440/460/ 4/86-12/96
5114808	Volvo	440/460/ 4/86-12/96
5114810	Volvo	S60/S80/V70 6/98-
5114811	Volvo	S60/S80/V70 6/98-
5114812	Volvo	940/960/S90/V90 8/90-12/98
5114813	Volvo	940/S90/V90 8/90-12/98
5115001	Daewoo	Nubria 5/97-
5115002	Daewoo	Nubria 5/97-
5115003	Daewoo	Leganza 6/97-
5115004	Daewoo	Leganza 6/97-
5115005	Daewoo	Leganza 6/97-
5115201	Suzuki	Baleno/Liana/Swift 10/84-
5115202	Suzuki	Grand Vitara 3/98-
5119301	Chrysler	Voyager II&III 1/95-

**Anvendelsesliste
Buyer's guide
Numerische Liste**

NK Nr./No.		
------------	---	---

NK Nr./No.		
------------	--	---

SBS Deutschland GmbH

Eichrodter Weg 57

D-99817 Eisenach

Tel.: 03691 - 257-100

Fax: 03691 - 257-110

www.sbs-automotive.de / www.sbs-shop.de

e-mail: verkauf@sbs-automotive.de